

1



2x - 1x1 Connector Pins



1x - 1x12 Beam

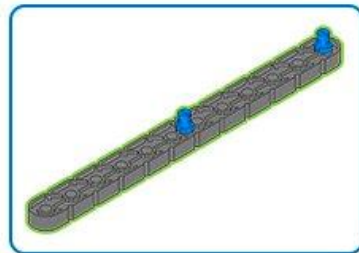
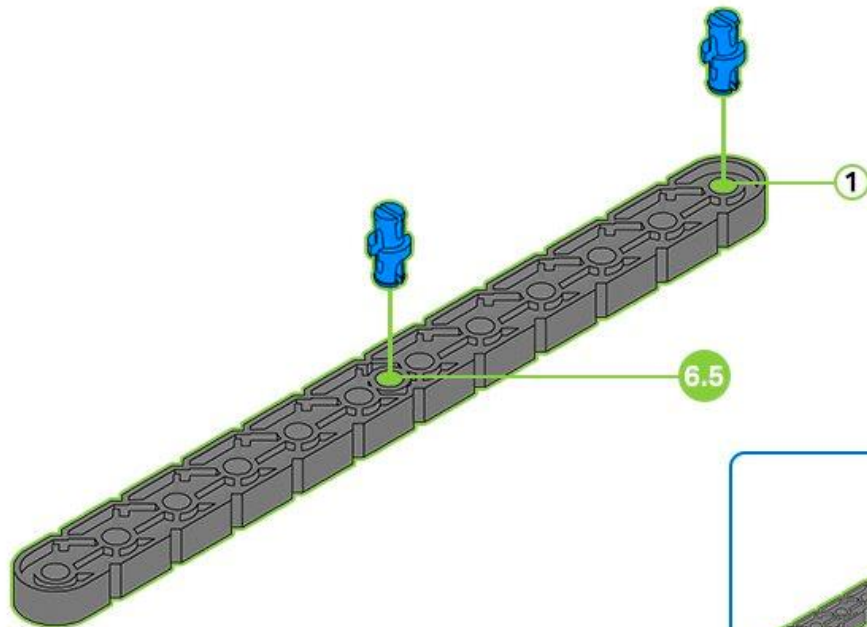

2



1x - 1x12 Beam

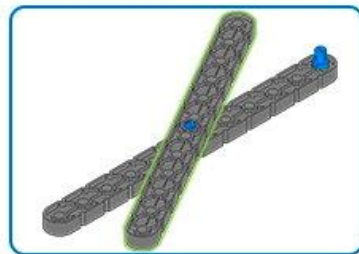
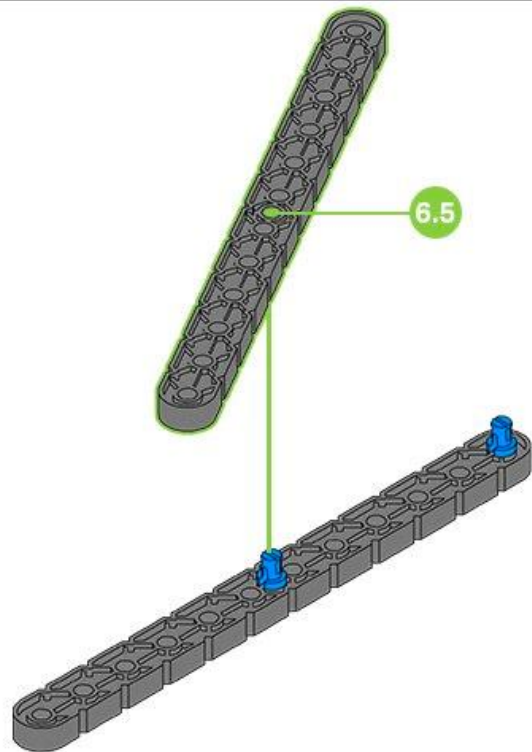

3



3x - 1x1 Connector Pins



1x - 1x12 Beam

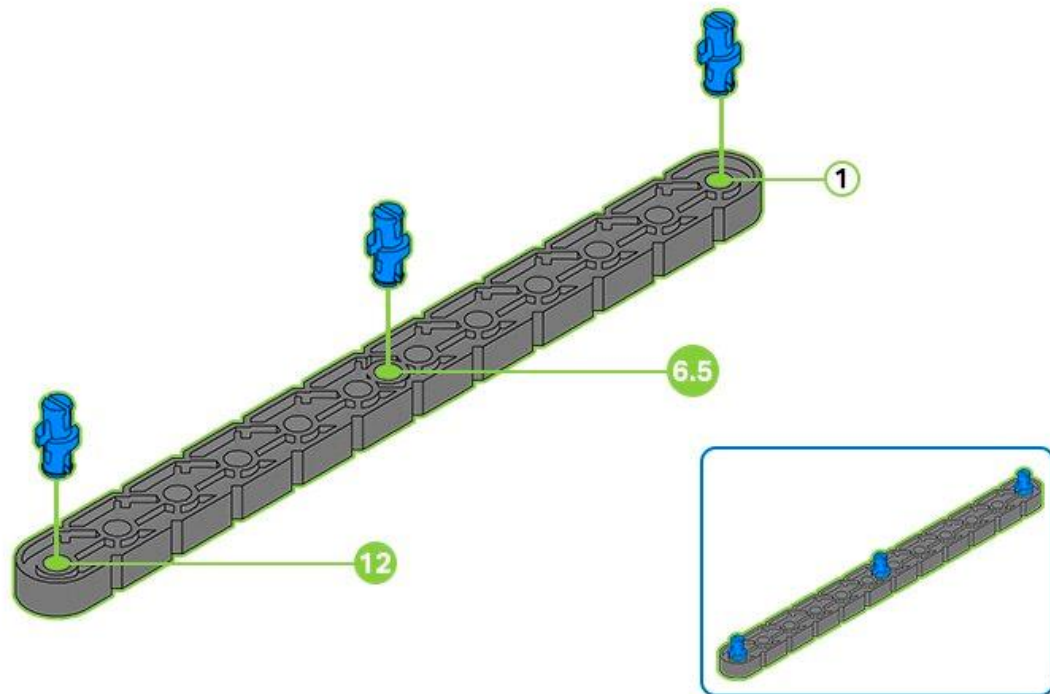

4



1x - Step 2 Assembly

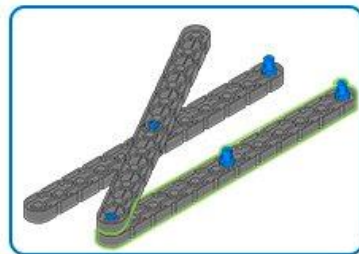
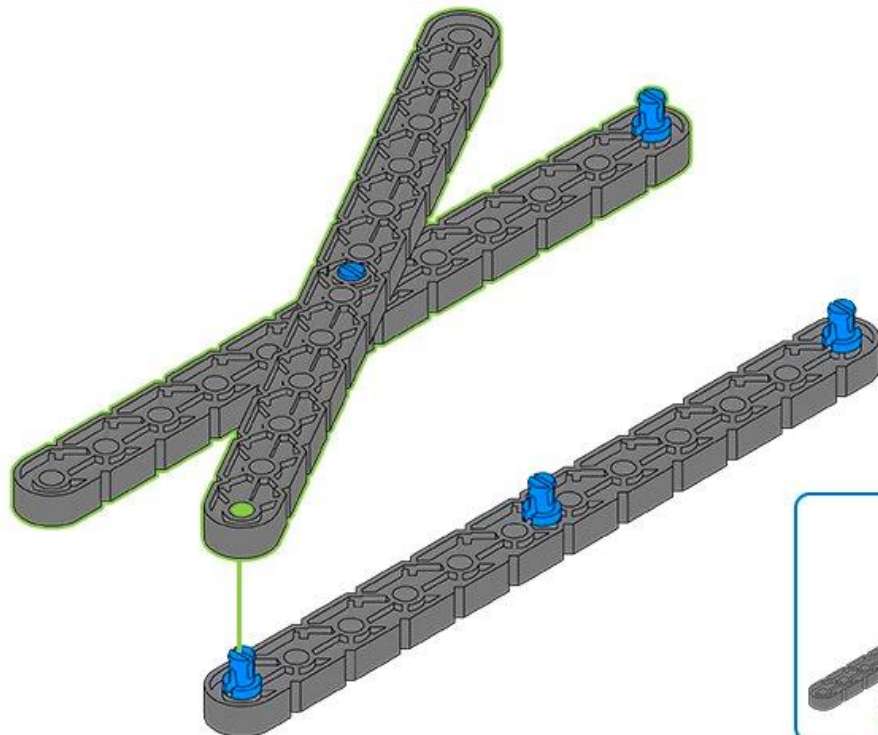

5



1x - 1x12 Beam

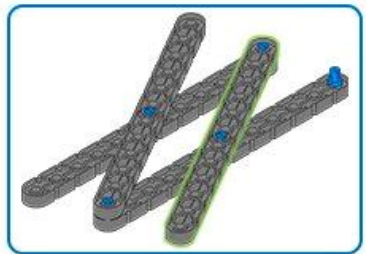
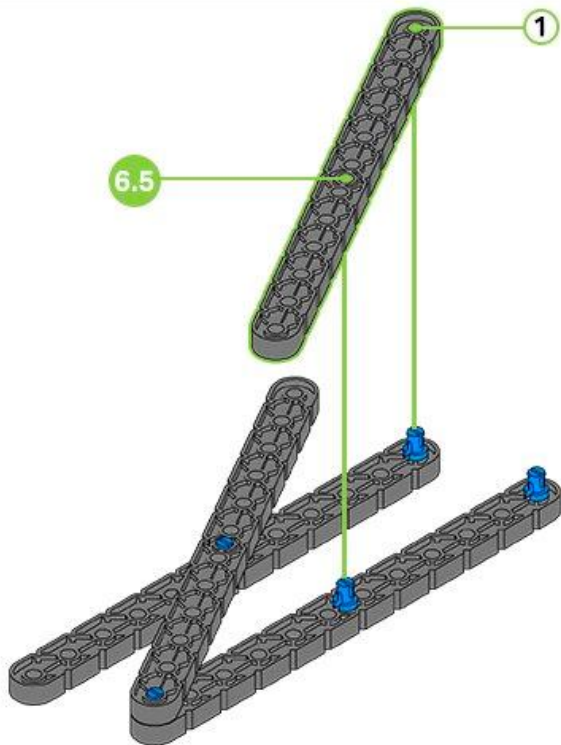

6



2x - 1x1 Connector Pins



1x - 1x8 Beam

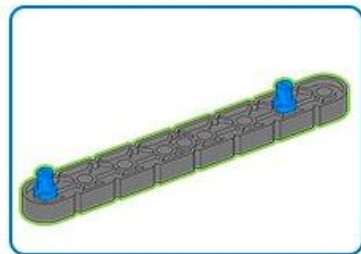
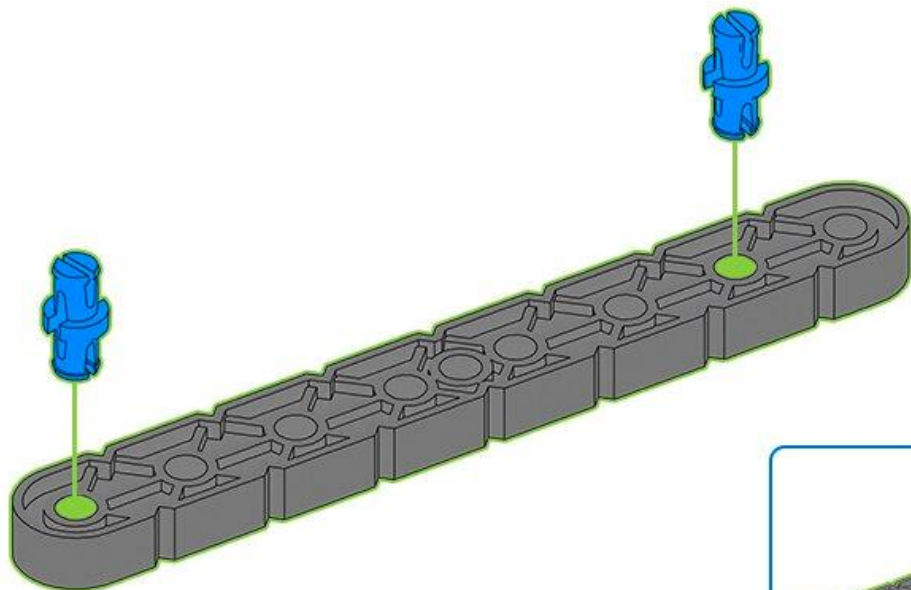

7



1x - Step 5 Assembly

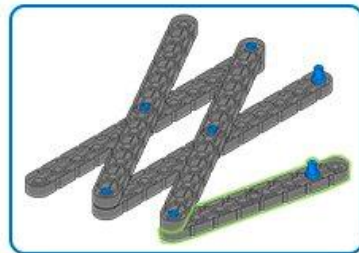
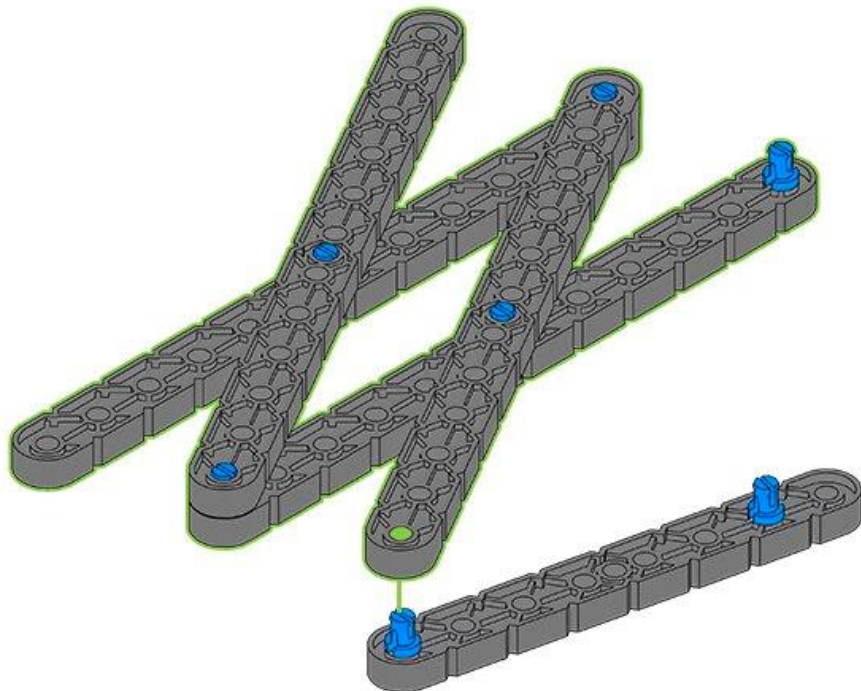



8



1x - 1x8 Beam

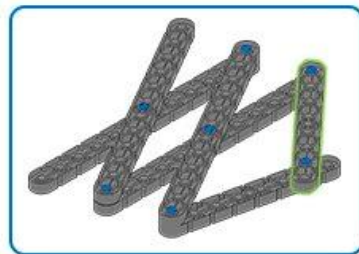
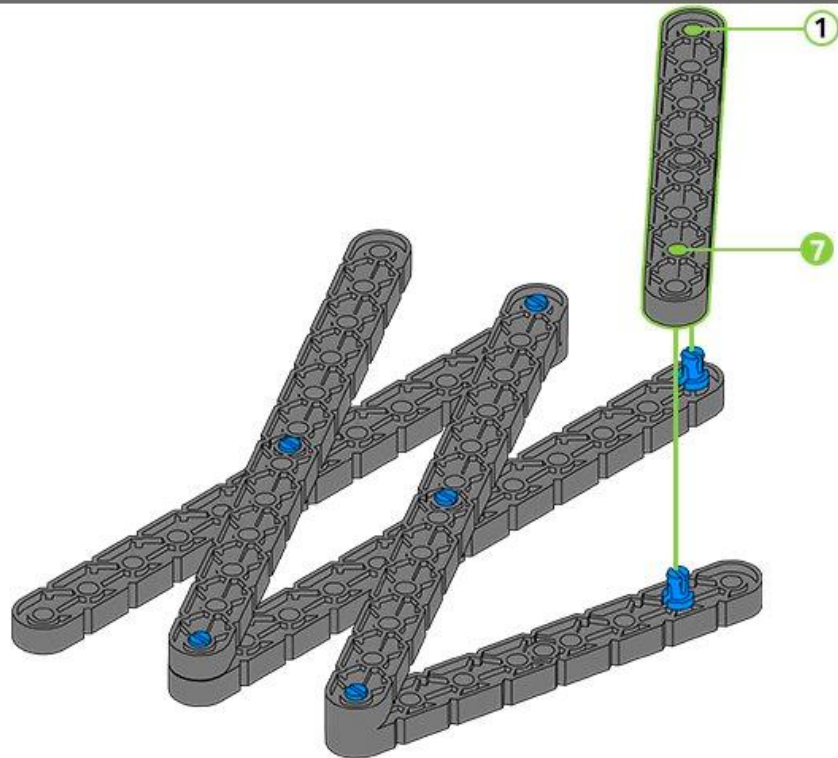

9



2x - 1x1 Connector Pins



1x - 1x6 Beam

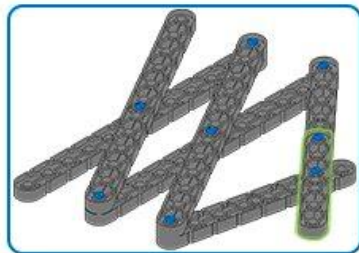
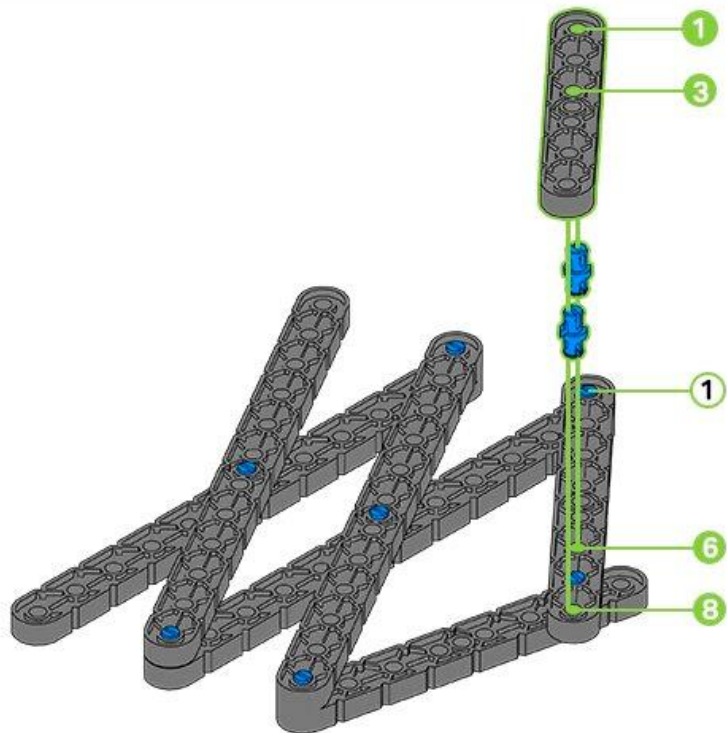

10



2x - 1x1 Connector Pins



1x - 1x6 Beam

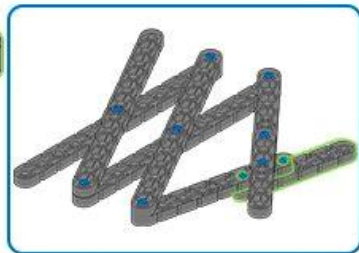
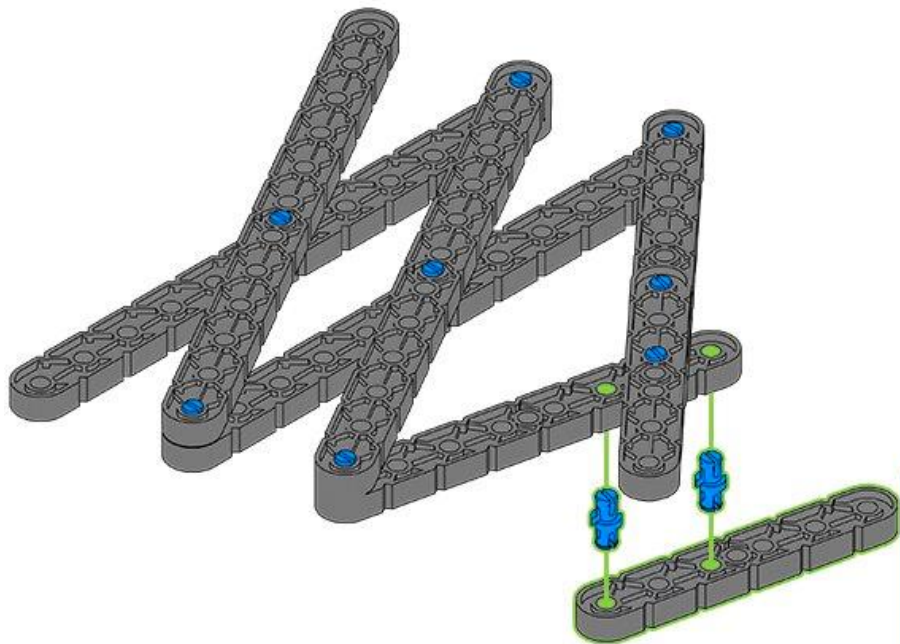



2x - 1x1 Connector Pins



1x - 3x4 Tee Beam

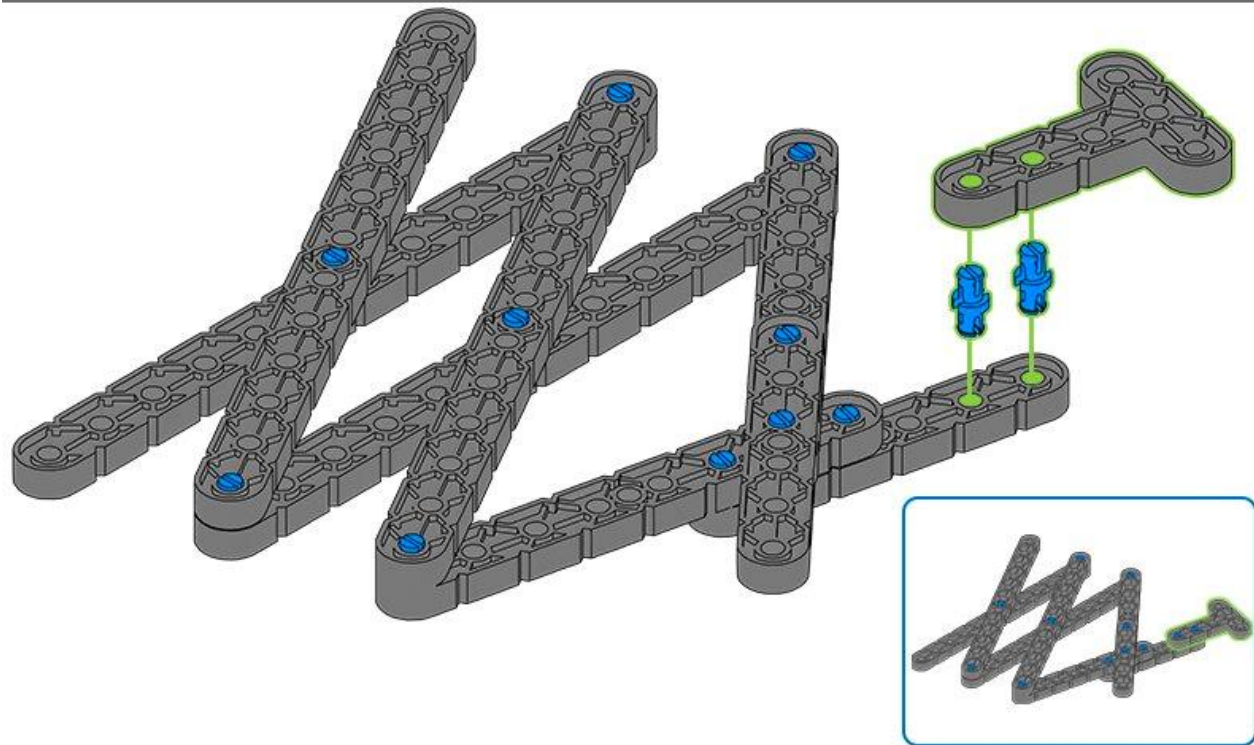

12

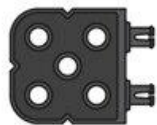

1x - 2x Wide, 2x2 Corner Connector

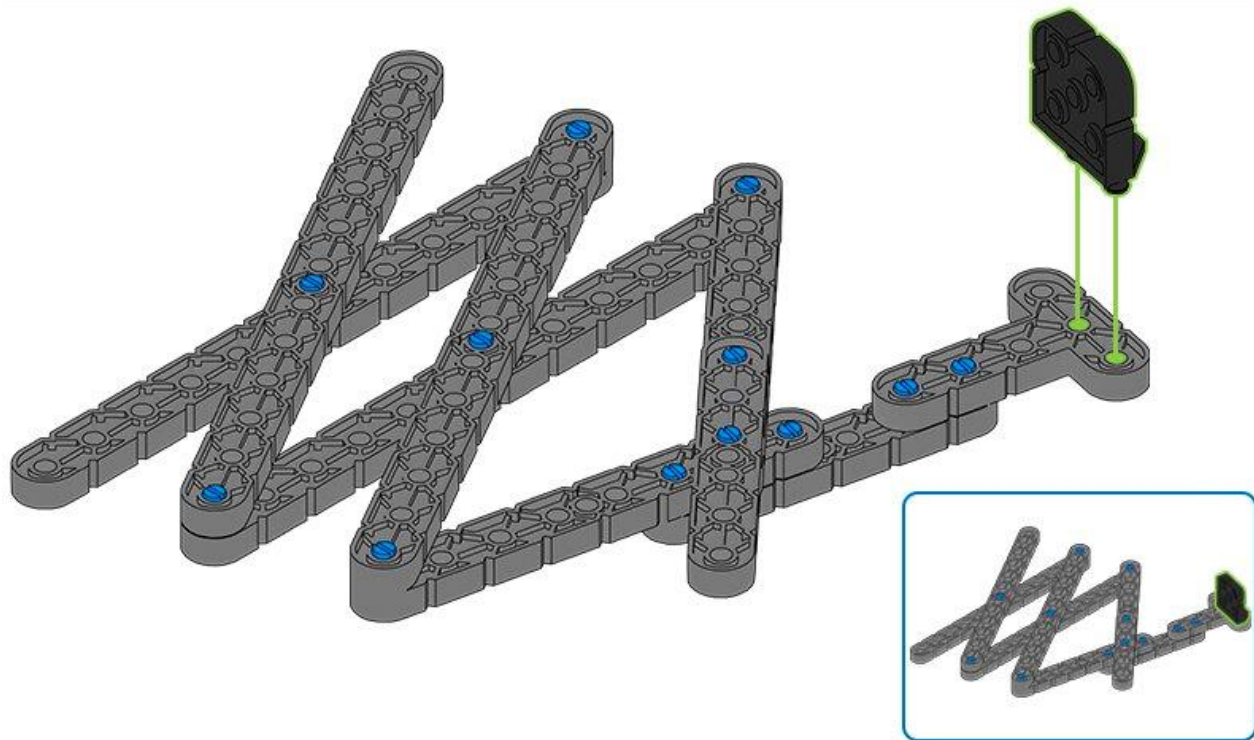

13



2x - 1x1 Connector Pins

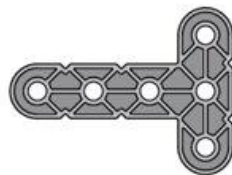

1x - 3x4 Tee Beam

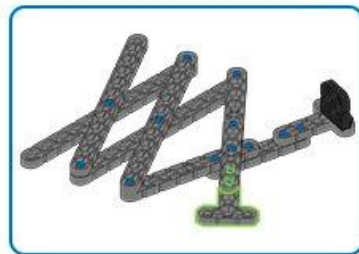
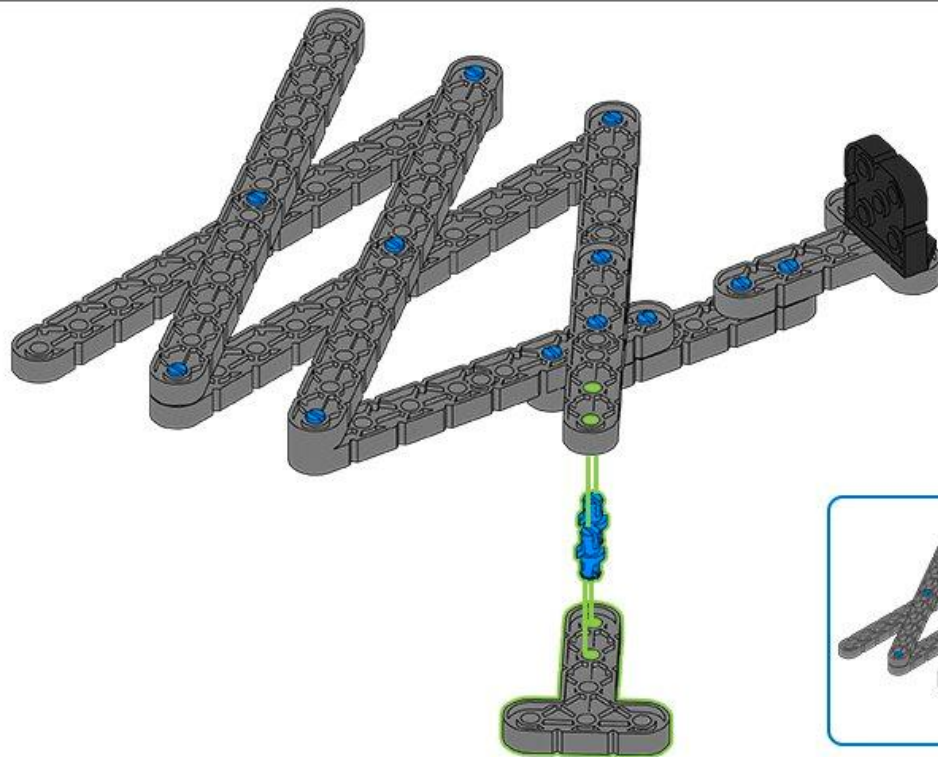

14



1x - 2x Wide, 1x2 Offset Corner Connector

