



vEX IQ
ROBOTICS
COMPETITION
LEVEL UP

2026 - 2027
Game Manual
Version 0.2



© 2026 Innovation First, Inc. / VEX Robotics, Inc. All rights reserved.

This Game Manual — including all game rules, game design concepts, scoring systems, field specifications, field element designs, robot construction parameters, tournament structures, game design philosophy, and all other content contained herein including all related intellectual property rights and registrations are the exclusive proprietary property of Innovation First, Inc. used under license by VEX Robotics, Inc. This document and all contents are subject to and protected under United States and International Copyright and Trademark Laws.

No portion of this document may be copied, reproduced, distributed, published, displayed, transmitted, adapted, translated, incorporated into any other work, or used as the basis for any modified or derivative version or work, - in whole or in part, in any form or by any medium, electronic or otherwise without the prior express written permission of Innovation First, Inc. / VEX Robotics, Inc.

This Game Manual is published solely for use in connection with authorized VEX Robotics Competitions and events. It may not be used, in whole or in part, for or in relation to any non-authorized Robotics event, competing competition program, alternative event format, independent game design, or related activity without the express prior written authorization of Innovation First, Inc. / VEX Robotics, Inc. Any and all unauthorized use of this material or any portion thereof — including adaptation for use in connection with any competing or successor robotics events, or competition program constitutes unauthorized and illegal misappropriation of Innovation First, Inc. / VEX Robotics, Inc.'s intellectual property and will be prosecuted to the fullest extent permitted by law.

VEX, VEX ROBOTICS, V5, VEX V5 ROBOTICS COMPETITION, VEX IQ, VEX IQ ROBOTICS COMPETITION, VEX ROBOTICS WORLD CHAMPIONSHIP, VEXPRO, VEXCODE, VEX 123, VEX GO, VEX AIR, and associated game names and logos (collectively VEX Trademarks) are registered trademarks and/or trademarks owned by Innovation First, Inc. Unauthorized use of the VEX Trademarks is strictly prohibited.

Violations of this notice and Innovation First, Inc.'s rights are subject to and/or will subject the responsible person(s) to civil and/or criminal liabilities and prosecution.

Table of Contents

Prefix

| | |
|-----------------------------|----|
| Changelog | v |
| Quick Reference Guide | vi |

Section 1 - Introduction

| | |
|--------------------------|---|
| Game Manual Updates..... | 3 |
| The Q&A System..... | 4 |

Section 2 - The Game

| | |
|---|----|
| VIQRC Level Up - A Primer | 7 |
| Field Overview..... | 8 |
| Game Design Philosophy - A Letter from the GDC. | 12 |
| Scoring..... | 13 |
| Specific Game Rules..... | 15 |
| Safety Rules | 18 |
| General Rules | 19 |
| General Game Rules | 24 |

Section 3 - Robot Skills Matches

| | |
|-------------------------------|----|
| Robot Skills Match Rules..... | 31 |
|-------------------------------|----|

Section 4 - The Robot

| | |
|-----------------------|----|
| Robot Summary..... | 36 |
| Inspection Rules..... | 37 |

Section 5 - The Event

| | |
|-----------------------|----|
| Inspection Rules..... | 46 |
|-----------------------|----|

Appendix A - Field Overview

Appendix B - Simplified Edition

| | |
|--------------------------------|----|
| Using this Appendix..... | B2 |
| Important Rules..... | B3 |
| How do you play Level Up?..... | B3 |
| How to Earn Points..... | B4 |
| Robot Rules..... | B5 |
| Drive Team..... | B5 |
| Matches and Referees..... | B5 |

Appendix C - Glossary of Terms

Appendix D - Rule Violations

| | |
|------------------------------|----|
| Violation Notes by Rule..... | D3 |
|------------------------------|----|

Appendix E - Team Classifications and Student Roles

Prefix

Changelog

Version 0.2 - June 4, 2026

- Updated Figure SG-1 to correctly show the approximate *Robot* starting position
- Updated <SG6> and its blue box to provide clarity regarding *Plowing*
- Updated Figure RSC3-1 to include a *Robot* in the correct starting position
- Updated the Robot Summary in section 4 to provide clarity
- Revised the definition of *Plowing* to include another *Scoring Object*
- Minor typo / formatting fixes

Version 0.1 - April 30, 2026

- Initial Release

Quick Reference Guide

| Scoring Rules | |
|---------------|--|
| <SC1> | All scoring statuses are evaluated after the <i>Match</i> ends |
| <SC2> | All scoring statuses are evaluated visually by a <i>Head Referee</i> |
| <SC3> | Scored <i>Bean Bag</i> in a <i>Floor Goal</i> criteria |
| <SC4> | Scored <i>Bean Bag</i> in a <i>L1, L2, or L3 Goal</i> criteria |
| <SC5> | Scored <i>Bean Bag</i> on a <i>L4 Goal</i> criteria |

| Specific Game Rules | |
|---------------------|---|
| <SG1> | Starting a <i>Match</i> |
| <SG2> | Horizontal expansion is limited |
| <SG3> | Vertical expansion is unlimited |
| <SG4> | Keep <i>Scoring Objects</i> in the <i>Field</i> |
| <SG5> | Each <i>Robot</i> gets one yellow <i>Bean Bag</i> as a <i>Preload</i> |
| <SG6> | <i>Possession</i> is limited to one (1) <i>Bean Bag</i> |
| <SG7> | Using the <i>Load Zone</i> |

| Safety Rules | |
|--------------|--|
| <S1> | Stay safe, don't damage the <i>Field</i> |
| <S2> | <i>Students</i> must be accompanied by an <i>Adult</i> |
| <S3> | Each <i>Student Team</i> member must have a completed participant release form on file |

| General Rules | |
|---------------|--|
| <G1> | Treat everyone with respect |
| <G2> | VIQRC is a <i>Student-centered</i> program |
| <G3> | Use common sense |
| <G4> | All work must represent the skill level of the <i>Students</i> on the <i>Team</i> |
| <G5> | Each <i>Student</i> can only belong to one <i>Team</i> |
| <G6> | There is a difference between accidentally and willfully violating a <i>Robot</i> rule |

General Game Rules

| | |
|---------------------|--|
| <GG1> | <i>Drivers drive your Robot, and stay in the Driver Station</i> |
| <GG2> | <i>A Team's Robot should attend every Match</i> |
| <GG3> | <i>Robots on the Field must be ready to play</i> |
| <GG4> | <i>Hands out of the Field</i> |
| <GG5> | <i>Match Replays are allowed, but rare</i> |
| <GG6> | <i>Disqualifications</i> |
| <GG7> | <i>Time-outs</i> |
| <GG8> | <i>Keep your Robot together</i> |
| <GG9> | <i>Don't damage the Field</i> |
| <GG10> | <i>Handling the Robot mid-Match is allowed under certain circumstances</i> |
| <GG11> | <i>A Team's two Drivers switch controllers midway through the Match</i> |
| <GG12> | <i>Don't start before the timer, and stop moving at the end of the Match</i> |
| <GG13> | <i>Ending a Match early</i> |
| <GG14> | <i>Drive Team Members are permitted to appeal the Head Referee's ruling</i> |

Robot Skills Challenge Rules

| | |
|---------------------|---|
| <RSC1> | <i>Standard rules apply in most cases</i> |
| <RSC2> | <i>Scoring Robot Skills Matches</i> |
| <RSC3> | <i>Robot and Field setup for Robot Skills Matches</i> |
| <RSC4> | <i>Loading and Driver differences</i> |
| <RSC5> | <i>Handling Robots during an Autonomous Coding Skills Match</i> |
| <RSC6> | <i>Starting an Autonomous Coding Skills Match</i> |
| <RSC7> | <i>Autonomous means "no humans"</i> |
| <RSC8> | <i>Skills Stop Time</i> |

Robot Rules

| | |
|-------|---|
| <R1> | One <i>Robot</i> per <i>Team</i> |
| <R2> | <i>Robots</i> must pass inspection |
| <R3> | <i>Robots</i> must fit within an 11" x 20" x 15" (279.4mm x 508mm x 381.0mm) volume |
| <R4> | <i>License Plates</i> |
| <R5> | Let it go after the <i>Match</i> is over |
| <R6> | <i>Robots</i> have one <i>Brain</i> |
| <R7> | Keep the power button accessible |
| <R8> | Firmware |
| <R9> | Motors |
| <R10> | Batteries |
| <R11> | One controller per <i>Robot</i> |
| <R12> | <i>Robots</i> are built from the VEX IQ product line |
| <R13> | Prohibited items |
| <R14> | Legal Non-VEX IQ components |
| <R15> | Decorations are allowed |
| <R16> | Pneumatics |
| <R17> | Modifications of parts |

Tournament Rules

| | |
|-------|--|
| <T1> | <i>Head Referees</i> have ultimate and final authority on all gameplay and <i>Robot</i> ruling decisions |
| <T2> | <i>Head Referees</i> must be qualified |
| <T3> | The <i>Drive Team Members</i> are permitted to immediately appeal the <i>Head Referee's</i> ruling |
| <T4> | The <i>Event Partner</i> has ultimate authority regarding all non-gameplay decisions |
| <T5> | Be prepared for minor <i>Field</i> variance |
| <T6> | <i>Fields</i> and <i>Field Elements</i> may be repaired at the <i>Event Partner's</i> discretion |
| <T7> | <i>Fields</i> at an event must be consistent with each other |
| <T8> | <i>Qualification Matches</i> will occur according to the official <i>Match Schedule</i> |
| <T9> | Each <i>Team</i> will be scheduled <i>Qualification Matches</i> as follows |
| <T10> | <i>Teams</i> are ranked by their average <i>Qualification Match</i> scores |
| <T11> | <i>Qualification Match</i> tiebreakers |
| <T12> | How <i>Alliances</i> are formed for <i>Teamwork Matches</i> |
| <T13> | <i>Teams</i> playing in <i>Finals Matches</i> . |
| <T14> | <i>Finals Match Schedule</i> |
| <T15> | <i>Skills Match Schedule</i> |
| <T16> | No requirement that <i>Skills Fields</i> have the same modifications as the <i>Teamwork Fields</i> |
| <T17> | <i>Skills Rankings</i> at events |
| <T18> | <i>Skills Rankings</i> globally |
| <T19> | <i>Robot Skills</i> at League Events |



vEX IQ
ROBOTICS
COMPETITION
LEVEL UP

2026 - 2027
Section 1 - Introduction

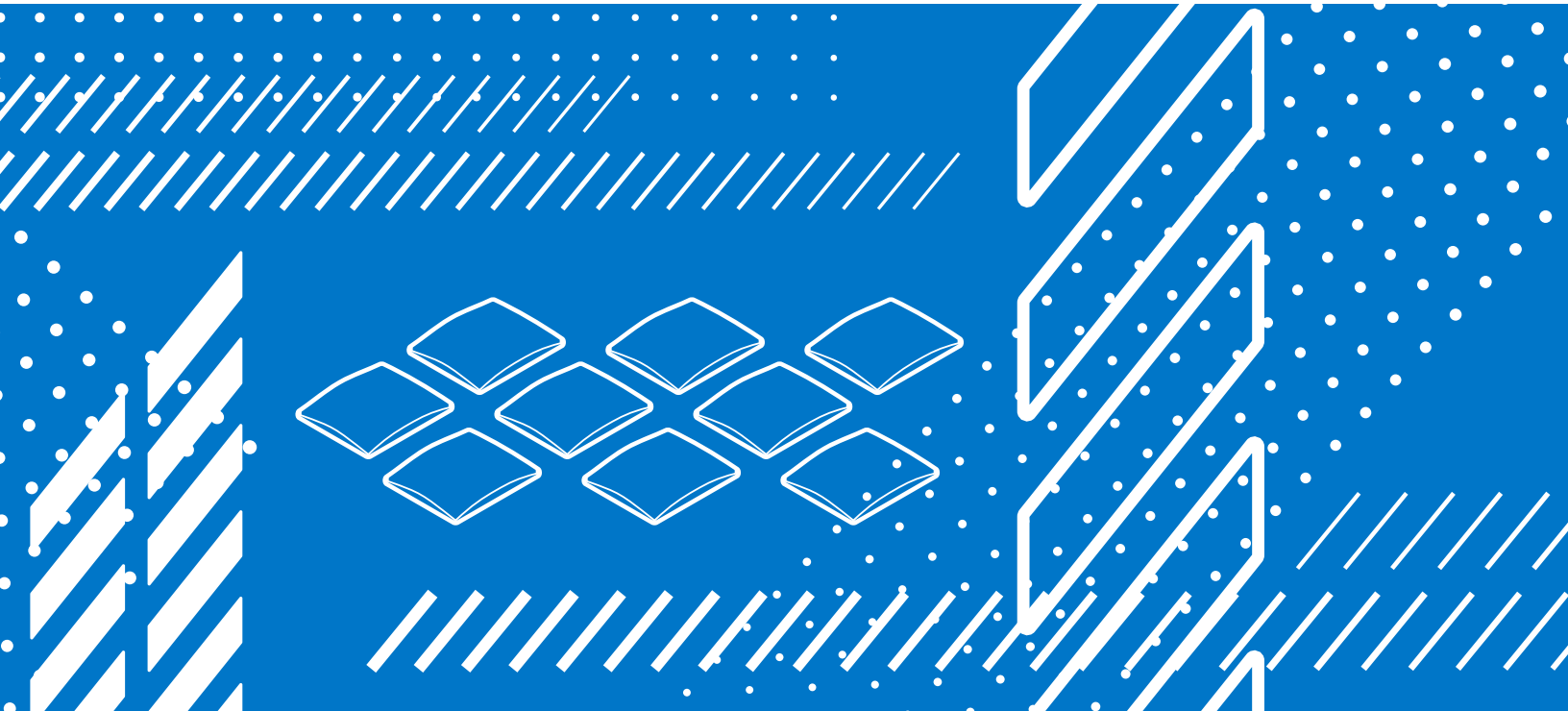

Section 1 - Introduction

About the Game Manual

The VEX IQ Robotics Competition Game Manual is the most authoritative source of information for the VEX IQ Robotics Competition. Contained within this document are all of the rules, boundaries, constraints, and other relevant information you will need to properly understand and play this year's game.

This manual is:

- A technical reference document for gameplay, *Robot* construction, and event operation
- A binding set of rules for *Teams*, coaches, referees, *Event Partners*, and all other volunteers and participants to adhere to
- The primary source of truth for all things related to the VEX IQ Robotics Competition

This manual is not:

- A strategy guide to score the most points
- An instruction set to build the best *Robot*
- A replacement for referee training, *Event Partner* training, or other Event Procedure

How to Read the Game Manual

The rules in this game manual are intended to work together to create a system of constraints. These rules are not intended to be understood independently of one another or in isolation from other information contained in this document. Many situations may require *Teams*, referees, or other volunteers to use logic from multiple places in the manual to properly form an interpretation. It is critical that the entire manual is read and understood, not just parts.

Information in the game manual is presented in the following ways:

Definitions in Appendix C establish the meaning of a term with regards to this document. Sometimes, these definitions may not perfectly match a more commonly accepted dictionary definition. In that case, the VEX definition takes precedence. If there is no VEX definition for a term, it can be reasonably assumed that a dictionary definition can be used.

General Rules establish the baseline rules for competition that *Teams* must adhere to at all times. These include, but are not limited to, conduct at an event, roster eligibility, competition integrity, and authority and enforcement.

General Game Rules begin to outline the rules that *Teams* must follow in every VEX game, not just the rules specific to this season's game. Many of these rules do not change from year to year, and help prevent the game from devolving into immediate chaos.

Scoring Rules define how points are earned and evaluated.

Specific Game Rules describe what *Robots* and *Drive Team Members* may and may not do during a *Match*, specifically for this season's game. These rules are subject to change from year to year, depending on how the game is designed and meant to be played.

Robot Rules define how *Robots* may be built and configured.

Tournament Rules describe how competitions are run, and how *Teams* are ranked at events.

Some rules also reference **Violation Notes** that are located in Appendix D. These notes provide additional guidance on enforcement, escalation, or special circumstances. If a rule doesn't include a cross-reference to *Violation Notes*, standard *Violation* definitions apply. See Appendix D for information about rule *Violations* and penalties.

There are also blue boxes of text placed in some areas of the game manual. These are intended to provide further clarification and guidance in places that the *Game Design Committee* has deemed may benefit from things being said a different way, or presented slightly differently. Blue Boxes are meant to be supplements to, not replace, rules or definitions.

Game Manual Updates

This manual will have a series of "major" and "minor" updates over the course of the season. Each version is official and must be used in official VIQRC events until the release of the next version, upon which the previous version becomes void.

The latest version of the Game Manual can always be found at: <https://link.vex.com/docs/26-27/viqrc/game-manual>.

Known major release dates are as follows:

| Release Date | Effective Date | Version # | Details |
|--------------------------|---------------------------|--------------------|---|
| April 30, 2026 | April 30, 2026 | Version 0.1 | Initial game release |
| May 14, 2026 | May 14, 2026 | N/A | Official Q&A system opens |
| June 4, 2026 | June 11, 2026 | Version 0.2 | Minor typographical errors or formatting issues found in the initial release, with very few rule changes expected |
| July 2, 2026 | July 9, 2026 | Version 1.0 | May include gameplay or rule changes inspired by input from the official Q&A system and the VEX community |
| August 6, 2026 | August 13, 2026 | Version 1.1 | Clarification / minor update |
| September 3, 2026 | September 10, 2026 | Version 2.0 | May include gameplay or rule changes inspired by early-season events |
| October 8, 2026 | October 15, 2026 | Version 2.1 | Clarification / minor update |
| December 3, 2026 | December 10, 2026 | Version 2.2 | Clarification / minor update |
| January 28, 2027 | February 4, 2027 | Version 3.0 | May include gameplay or rule changes inspired by early-season events |
| March 25, 2027 | April 1, 2027 | Version 4.0 | May include gameplay or rule changes pertaining specifically to the VEX Robotics World Championship |

In addition to these known major updates, there may also be unscheduled updates released throughout the season if deemed critical by the *Game Design Committee*.

Any scheduled or unscheduled updates will always be released on a Thursday, no later than 5:00 PM CST (11:00 PM GMT). These updates will be announced via the VEX Forum, automatically pushed to the VEX IQ Hub app, and shared via VEX Robotics social media & email marketing channels. Once announced, the new version of the Game Manual will be immediately available at the link above.

Generally, Level Up Game Manual updates, scheduled or unscheduled, will include a **grace period** before the updated rules go into effect for competitions. See the release table above for specific dates. This grace period does not apply to the **Version 0.1 Release**, which serves as the initial rule set for the season.

Any events that begin **before** the 7-day grace period has ended must **continue using the rules from the previous Game Manual release**. This policy ensures fairness and consistency, allowing Teams to adapt their strategies and gameplay accordingly before the changes are enforced in official competitions.

Once a manual update occurs, the previous version will be re-uploaded with an "Obsolete" watermark. Those will be found at <https://link.vex.com/docs/26-27/viqrc/game-manual-obsolete> and will be available to reference through the rest of the season.

The *Game Design Committee* reserves the right to enforce critical updates to the Game Manual as effective immediately upon release, if we feel that the changes are critical for competitive integrity, safety, and/or other extenuating circumstances.

Multi-week league events (or similar) that cross over a grace period should use the version of the Game Manual that is in effect at the beginning of each league session. Leagues should update to new versions of the Game Manual between sessions as appropriate.

The Q&A System

When first reviewing a new robotics game, it is natural to have questions about situations which may not be immediately clear. Navigating the Game Manual and seeking out answers to these questions is an important part of learning a new game. In many cases, the answer may just be in a different place than you first thought—or, if there is no rule explicitly prohibiting a gameplay strategy, then that usually means it is legal!

However, if a *Team* is still unable to find an answer to their question after closely reviewing the relevant rules, then every *Team* has the opportunity to ask for official rules interpretations in the VEX Robotics Question & Answer System. These questions may be posted by an *Adult* via the events.vex.com account that is associated with that *Team*.

All responses in this Q&A system should be treated as official rulings from the VEX Robotics *Game Design Committee*, and they represent the correct and official interpretation of the VEX Robotics Competition Rules. The Q&A system is the only source besides the Game Manual for official rulings and clarifications, and is functionally an extension of the Game Manual. Q&A rulings are effective immediately upon release.

The VEX IQ Robotics Competition Question & Answer System will open on May 14th, 2026. Before posting on the Q&A system, be sure to review the Q&A Usage Guidelines:

1. The Q&A system is for rules clarifications only.
2. Only registered *Teams*, certified *Event Partners*, and certified *VIQRC Head Referees* can post questions.
3. Read and search this Game Manual before posting.
4. Read and search existing Q&As before posting.
5. Quote the applicable rule from the latest version of this Game Manual in your question.
6. Make a separate post for each question.
7. Use specific and appropriate question titles.
8. Questions will (mostly) be answered in the order they were received.
9. This system is the only source for official rules clarifications.
10. The *Game Design Committee* cannot and will not overrule a *Head Referee's* decision.

If there are any conflicts between the English-language PDF of the Game Manual and other supplemental or translated materials (e.g., referee training materials, the VIQRC Hub app, the game reveal video, a translated game manual, etc.), the most current version of the English-language PDF of the Game Manual takes precedence.

Similarly, it can never be assumed that definitions, rules, or other materials from previous seasons apply to the current game. Q&A responses from previous seasons are not considered official rulings for the current game. Any relevant clarifications that are needed should always be re-asked in the current season's Q&A.

Hierarchy of Information

There is no rule in this game manual that is more important than another rule. All rules are intended to be enforced with the same vigor.

The following hierarchy applies when determining official rulings while using information from beyond the Game Manual:

1. The most current English-language PDF of this Game Manual
2. Official rulings published in the VEX Robotics Question & Answer (Q&A) system
3. All other supplementary documents, policies and media

The latest version of the game manual supersedes all previous versions once effective (see the Game Manual Updates section, for more information). If discrepancies exist between this manual and other materials (videos, apps, translations, training documents), the latest version of the English-language PDF version of this manual takes precedence.



vEX IQ
ROBOTICS
COMPETITION
LEVEL UP

2026 - 2027
Section 2 - The Game

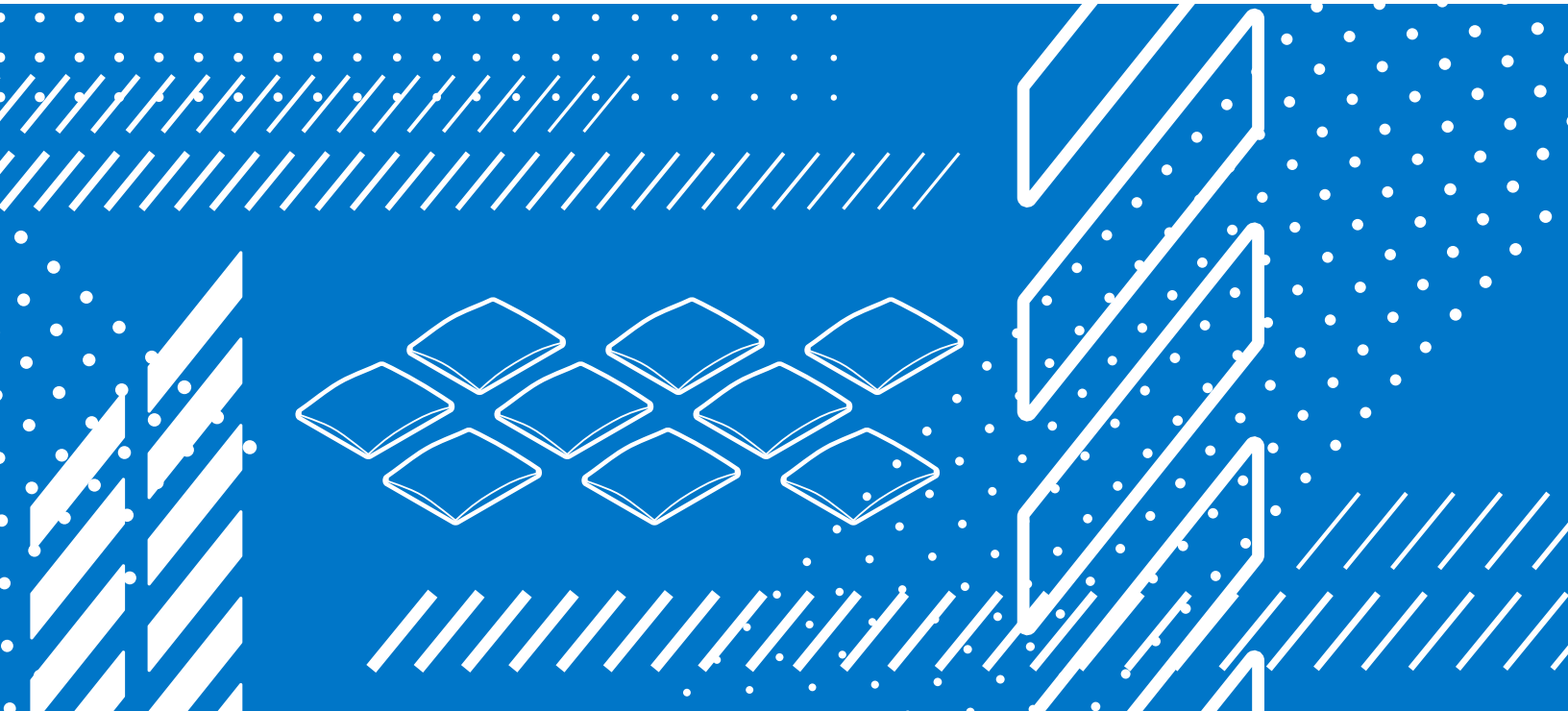

Section 2 - The Game

VIQRC Level Up - A Primer

VEX IQ Robotics Competition Level Up is played on a 6'x8' rectangular *Field*, set up as illustrated in the figures throughout this game manual.

The primary objective of the game is to score *Bean Bags* into *Goals*. Higher *Goals* earn more points. A *Robot* can only carry one *Bean Bag* at a time, and most *Bean Bags* have to travel across the entire *Field* to reach their *Goals*. *Teams* have to decide whether to drive a long path or design their *Robot* to fit through the narrow shortcuts on the *Field*.

In *Teamwork Matches*, an *Alliance* composed of two *Robots* works together to score as many points as possible in a 60-second *Match*.

Teams may also compete in *Robot Skills Matches*, where one *Robot* tries to score as many points as possible with a slightly different set of rules. See Section 3 for more information.

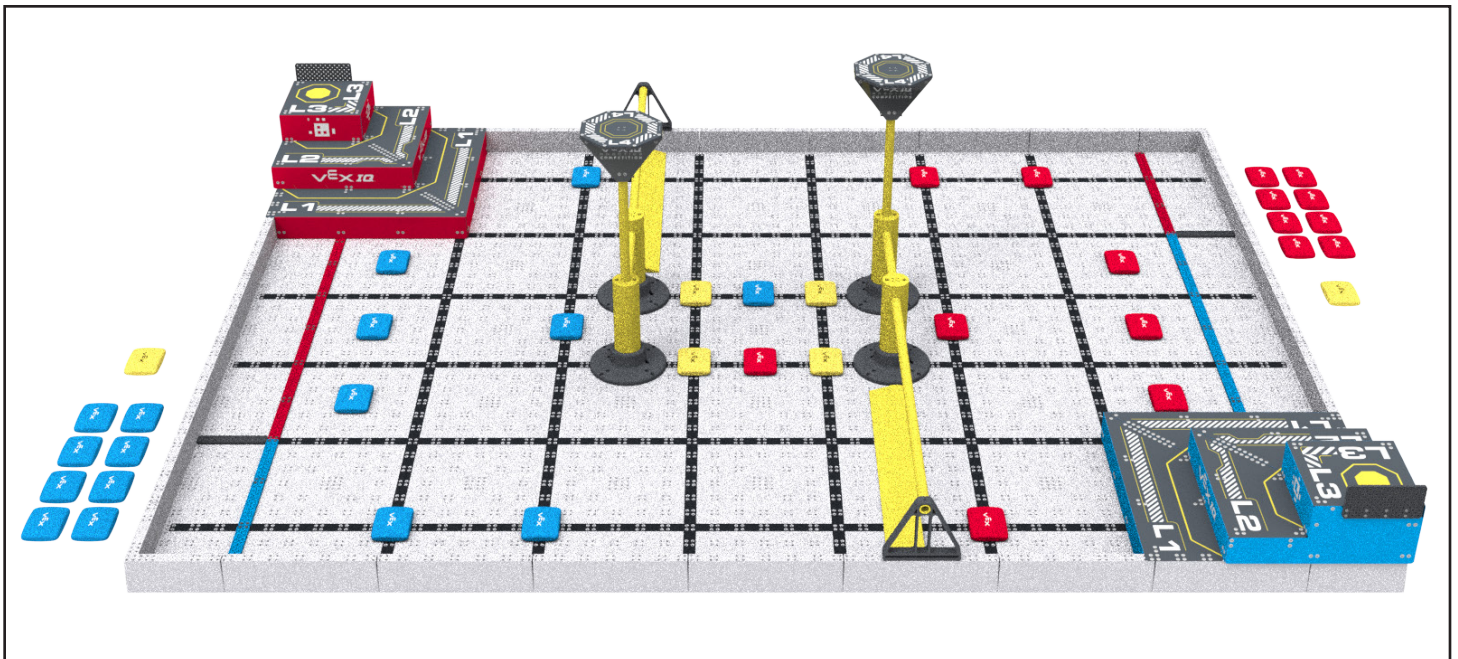

Field Overview

The VEX IQ Robotics Competition Level Up *Field* consists of the following:

- 38 *Bean Bags*
 - 16 blue *Bean Bags*
 - 8 that start in the *Field*
 - 8 that can be introduced through the blue *Load Zone*
 - 16 red *Bean Bags*
 - 8 that start in the *Field*
 - 8 that can be introduced through the red *Load Zone*
 - 6 yellow *Bean Bags*
 - 2 *Preloads*, one for each *Team*
 - 4 that start in the *Field*
- Two *Pyramid Goals*, one red and one blue
- Two *L4 Goals*
- Two *Floor Goals*, one red and one blue
- Two *Load Zones*, one red and one blue
- Two wall structures
- Two *Floor barriers*

*Note: The illustrations in this section of the Game Manual are intended to provide a general visual understanding of the game. **Some figures may highlight or change the appearance of certain Field Elements and Scoring Objects to emphasize or clarify intent.***

Teams should refer to official Field specifications, found in Appendix A, for exact Field dimensions, a full Field bill of materials, and exact details of Field construction.

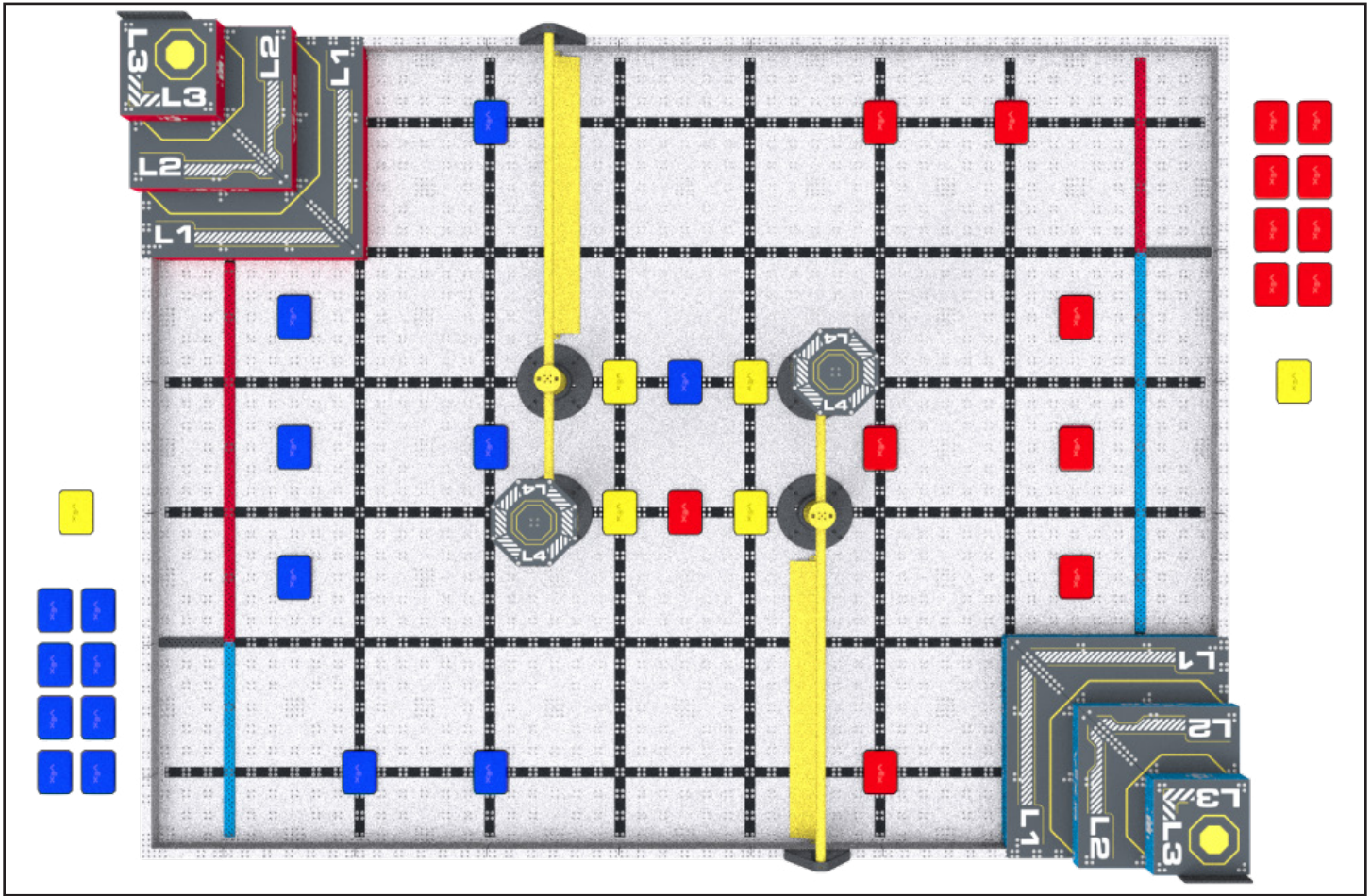

Figure FO-1: Starting configuration of a VIQRC Level Up Field Teamwork Match with Bean Bags highlighted (Red, Blue, Yellow).

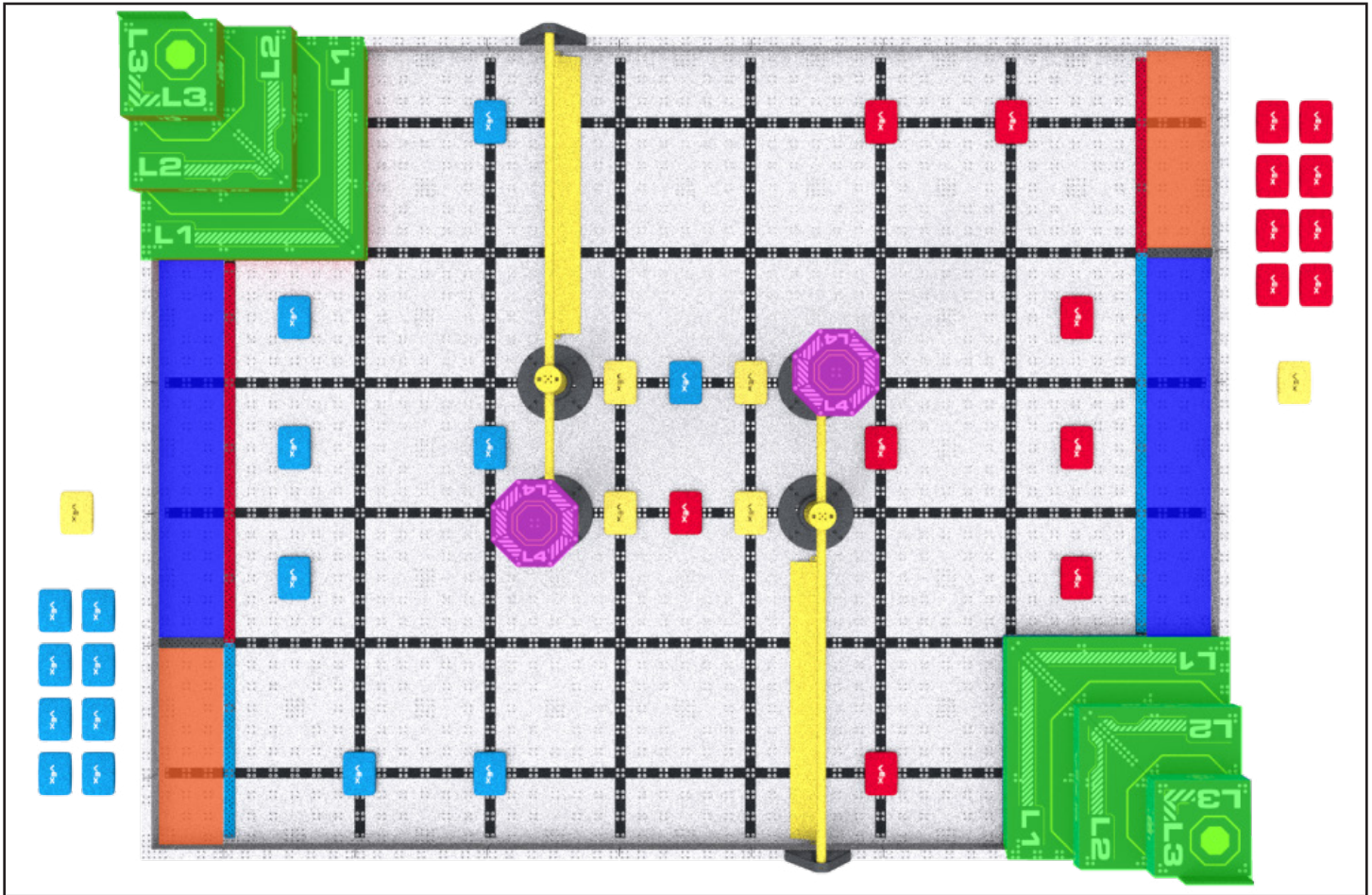

Figure FO-2: A VIQRC Level Up Field, with Pyramid Goals (green), L4 Goals (purple), Floor Goals (blue) and Load Zones (orange) highlighted.

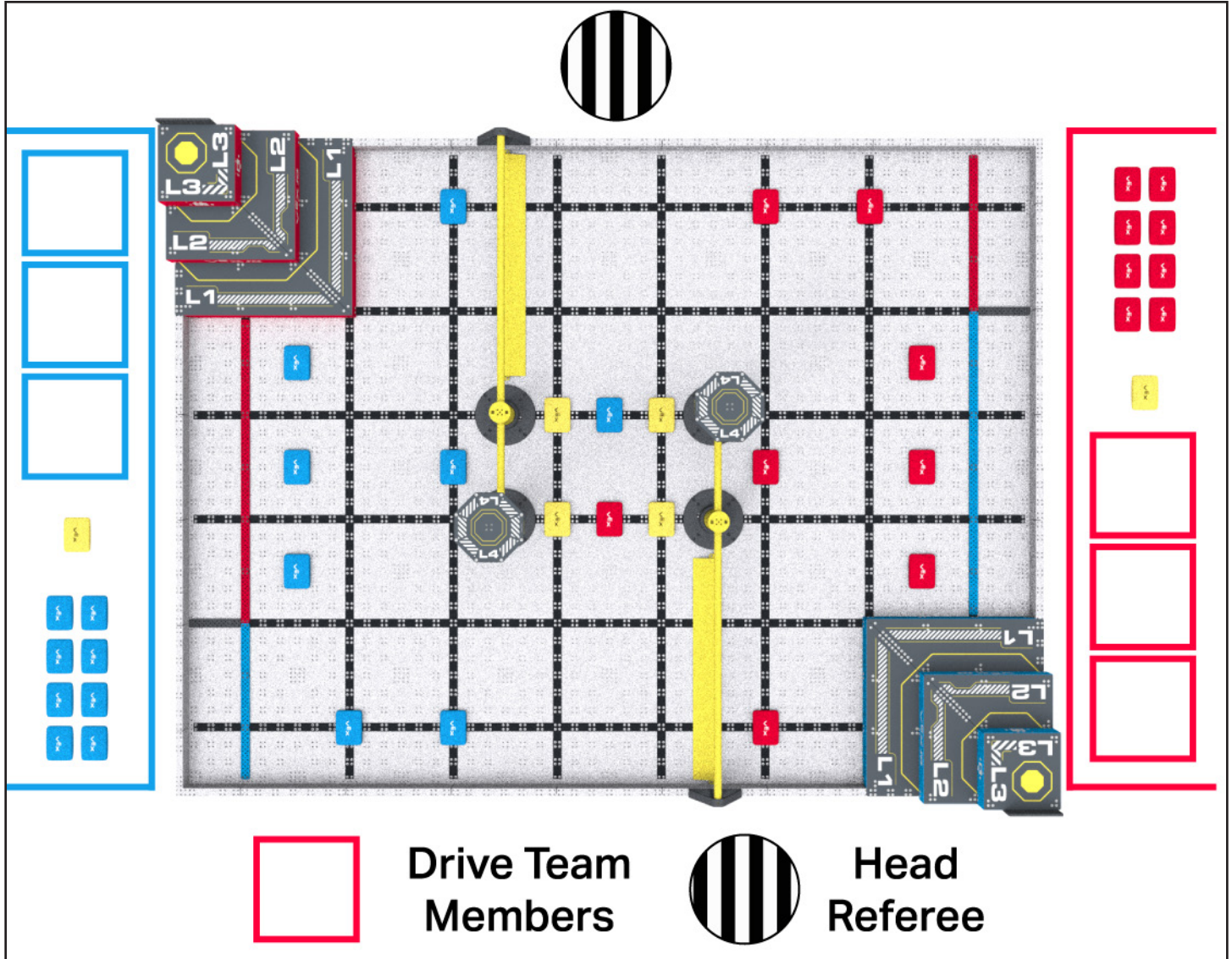

Figure FO-3: The recommended locations for Drive Team Members and Head Referees during Teamwork Matches.

Game Design Philosophy - A Letter from the GDC

We as the *Game Design Committee* want to explain how this game was designed and how we expect it to be played. We will also point out parts of the game we will watch during the season in case changes are needed.

This section is not a list of rules. It is here to help you understand what the game is about and what we as designers had in mind.

Level Up is a game where *Robots* move around the *Field* again and again to score. You can only move one *Bean Bag* at a time. Because of this, *Teams* will need to score often and move quickly. The game rewards *Robots* that can repeat actions and follow a plan.

Navigation and Route Choice

The *Field* is designed to give *Teams* choices about how their *Robot* moves.

Some paths are longer but more open and easier to use. Other paths are shorter but tighter and harder to move through. *Teams* will need to decide which path works best for their *Robot*.

Robot Design Tradeoffs

The way your *Robot* is built will affect how it moves on the *Field*.

Smaller *Robots* may be able to use shortcuts. Larger *Robots* may be more stable or easier to control. *Teams* will need to make choices about what is most important for their design.

There is no one "best" design. Different *Robots* can succeed in different ways.

Scoring Strategy

There are *Goals* with different heights and point values on the Level Up *Field*. This gives *Teams* choices about how they want to work with their partner and score.

Some *Teams* may try to score higher points each time. Others may focus on scoring faster. The best strategies will balance how many points you score, how quickly you score, and how often your *Robot* can repeat the action.

Commitment to Teams

The *Game Design Committee* will watch how *Matches* are played during the season. We want to make sure the game stays fun, fair, and interesting!

If needed, we may make updates to keep the focus on movement, scoring, and teamwork.

Have a great season!

- The VEX IQ Robotics Competition *Game Design Committee*

Scoring

| | |
|--|-----------|
| Each <i>Bean Bag</i> scored in a <i>Floor Goal</i> | 1 Point |
| Each <i>Bean Bag</i> scored in an <i>L1 Goal</i> | 3 Points |
| Each <i>Bean Bag</i> scored in an <i>L2 Goal</i> | 6 Points |
| Each <i>Bean Bag</i> scored in an <i>L3 Goal</i> | 12 Points |
| Each <i>Bean Bag</i> scored on a <i>L4 Goal</i> | 16 Points |

<SC1> All scoring statuses are evaluated after the Match ends, once all *Scoring Objects*, *Field Elements*, and *Robots* on the *Field* come to rest. See rule <GG12> for more information and *Violation* details.

- Referees should avoid contacting or moving *Robots* and/or *Scoring Objects* as much as possible while evaluating scoring statuses. If an object must be moved to evaluate the status of another object, its status must be agreed upon by all *Teams* and the *Head Referee*, and noted or recorded, before it is moved.

<SC2> All scoring statuses are evaluated visually by a *Head Referee*, to the best of their ability within the context of a given *Match*/event.

- Referees and other event staff are not allowed to review any videos or pictures from the *Match*. See <T3>.
- If there is a concern regarding the score of a *Match*, only the *Drive Team Members* from that *Match*, not an *Adult*, may share their questions with the *Head Referee*. See <T3>.

<SC3> A *Bean Bag* is scored in a **Floor Goal** if it meets all of the following criteria.

- No part of the *Bean Bag* is contacting a *Robot*.
- The *Bean Bag* is entirely within the defined area of the *Floor Goal* (e.g., no part of the *Bean Bag* is on top of the *Field Perimeter* or the VEX IQ parts that define the *Floor Goal*).
- The *Bean Bag* is yellow, or matches the color of the *Floor Goal*.

Figure SC3-1: *Bean Bags in the Floor Goal.*

- The red *Bean Bag* would not be considered scored, as it is resting on top of the VEX IQ parts that make up the *Floor Goal*, and not entirely within the defined area.
- The blue *Bean Bag* would not be considered scored, as it does not match the color of the *Floor Goal*.
- The yellow *Bean Bag* would be considered as scored, as it can be scored in either color *Floor Goal*, and is entirely within the defined area.

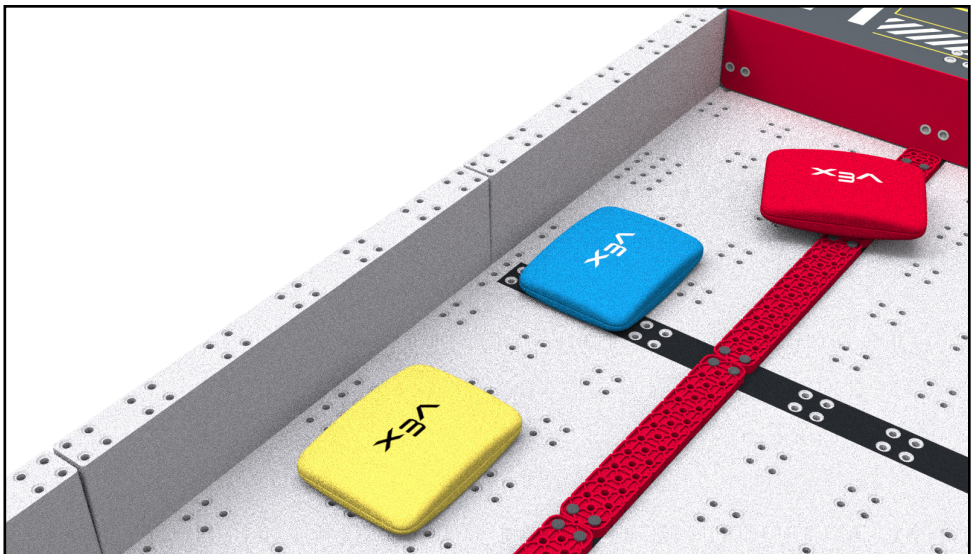

<SC4> A *Bean Bag* is **scored in an L1, L2, or L3 Goal** if it meets all of the following criteria:

- No part of the *Bean Bag* is contacting a *Robot*.
- The *Bean Bag* is in contact with the horizontal PET sheet that defines the L1, L2, or L3 Goal, or is supported by another *Bean Bag* that is in contact with that PET sheet.
- The *Bean Bag* is not in contact with anything outside the *Field*.
- The *Bean Bag* is yellow, or matches the color of the L1, L2, or L3 Goal.

If a *Bean Bag* counts as scored in multiple tiers (e.g., stacked on other *Bean Bags* in L1 and in contact with L2), it should receive the points for the lower tier.

Figure SC4-1: *Bean Bags* in the Pyramid Goal.

- The blue *Bean Bag* would not be considered scored, as it does not match the color of the L1 Goal it is resting on.
- The three (3) red *Bean Bags* would all be considered as scored in the L2 Goal, as they match the color of the Goal, and are all in direct contact with the PET sheet that makes up the Goal, or supported by another *Bean Bag* in contact with the sheet.
- While the yellow *Bean Bag* is contacting the PET sheet of the L3 Goal, it would be considered as scored in the L2 Goal, as it also counts as scored in the L2 Goal.

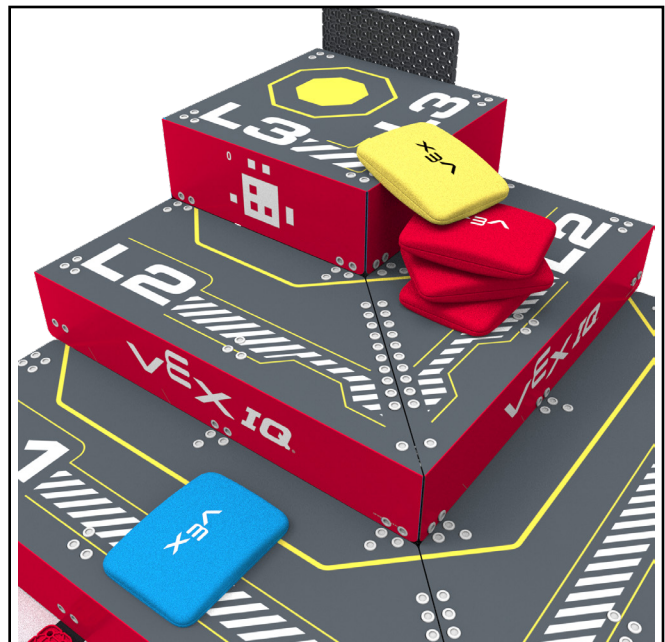

<SC5> A *Bean Bag* is **scored on a L4 Goal** if it meets all of the following criteria.

- No part of the *Bean Bag* is contacting a *Robot*.
- The *Bean Bag* is in contact with the horizontal PET sheet at the top of the L4 Goal, or is supported by another *Bean Bag* that is in contact with that PET sheet.
- The *Bean Bag* is yellow.

Figure SC5-1: *Bean Bags* on the L4 Goal.

- Both yellow *Bean Bags* would be considered as scored, as they are directly touching the PET sheet, or supported by another *Bean Bag* in contact with the sheet.
- The red *Bean Bag* would not be considered as scored, as only yellow *Bean Bags* can be scored on the L4 Goal.



Specific Game Rules

<SG1> Starting a Match. At the beginning of a *Match*, the *Robot* must be placed such that it meets all of the following criteria:

- a. Fit within an 11" wide x 20" long x 15" high (279mm x 508mm x 381mm) volume, as checked during inspection per <R3>.
- b. Positioned within one of the starting positions shown in Figure SG-1.
 - i. For *Teamwork Challenge Matches*, the *Team* listed as *Team 1* (printed *Match* list), listed as red *Team* (events.vex.com), or listed first (VEXvia) must place their *Robot* in the starting position that shares a wall with the blue *Pyramid Goal*.
 - ii. For *Teamwork Challenge Matches*, the *Team* listed as *Team 2* (printed *Match* list), listed as blue *Team* (events.vex.com), or listed second (VEXvia) must place their *Robot* in the starting position that shares a wall with the red *Pyramid Goal*.
- c. Completely stationary (i.e., no motors or other mechanisms in motion) until the *Match* timer starts. Pre-charging a pneumatic system (e.g., having the Pneumatic Pump running prior to the *Match*) is the only permitted exception to this rule.
- d. The starting configuration of the *Robot* at the beginning of a *Match* must be the same as a *Robot* configuration that was checked during *Robot* inspection.

This rule has additional Violation notes. See Appendix D.

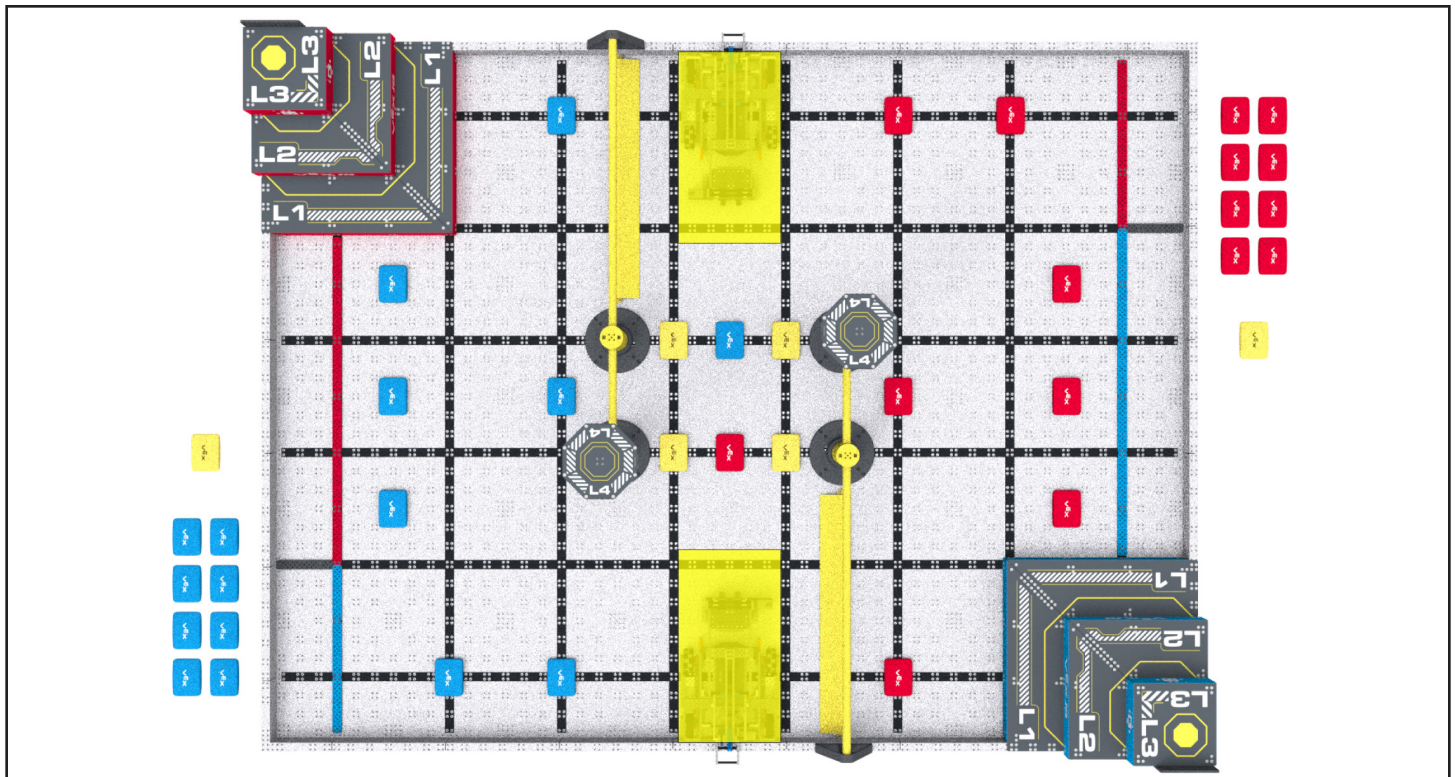

Figure SG-1: Robots in legal pre-Match starting positions (highlighted in yellow).

<SG2> Horizontal expansion is limited. Once the *Match* begins, *Robots* may expand horizontally up to a length of 24". The *Robot* can never be larger than 11"x24", and must always be able to fit within an 11"x24" rectangular horizontal footprint.

Teams should be aware that *Robots* may incidentally expand horizontally while extending vertically (e.g., mechanisms that arc, swing, or deploy upward). Upon request, *Teams* must be prepared to demonstrate that their *Robot* does not exceed the maximum size constraint of 11" x 24" at any point, including while any vertical expansion mechanisms are in use.

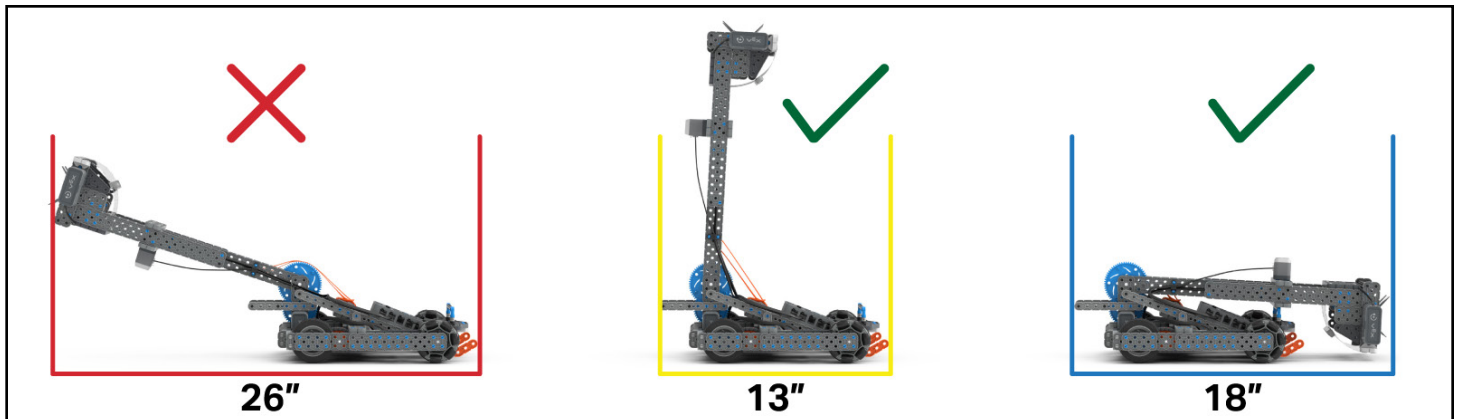

Figure SG2-1: A demonstration of how the size of the *Robot* may change horizontally through the course of a vertical expansion. The *Robot* on the far left is extended beyond 24", and would be in Violation of <SG2>.

<SG3> Vertical expansion is unlimited. Once the *Match* begins, *Robots* may expand vertically beyond the 15" starting size limit with no limits.

<SG4> Keep Scoring Objects in the Field. *Scoring Objects* that leave the *Field* during a *Match* will not be returned to the *Field*, and cannot be reintroduced by the *Loaders*.

- "Leaving the *Field*" means that a *Scoring Object* is outside of the *Field Perimeter*, no longer in contact with the *Floor* or *Field Elements*, and not supported by *Robots* or *Scoring Objects* that are still inside the *Field*.
- If a *Scoring Object* is removed from a *Robot* during a <GG10> interaction, it is considered "out of the *Field*" as soon as it is no longer in contact with any *Robots*.
- If a *Scoring Object* is on its way out of the *Field* (as determined by the *Head Referee*), but is deflected back into the *Field* by a *Drive Team Member*, field monitor, ceiling/wall, or other external factor, <SG4> would still apply. This *Scoring Object* should be considered "out of the *Field*" and removed by a *Head Referee*.
- A *Scoring Object* that comes to rest on top of the *Field Perimeter* is still considered to be inside the *Field* unless it contacts something outside of the *Field* (e.g., volunteer, *Drive Team Member*, field monitor, etc.), and cannot be retrieved by a *Drive Team Member* or volunteer.

<SG5> Each Robot gets one yellow Bean Bag as a Preload. Prior to the start of each *Match*, each *Preload* must be placed such that it meets all of the following criteria:

- Contacting exactly one *Robot*.

- b. Not contacting any *Field Elements* (excluding the *Floor*), *Goals*, or other *Scoring Objects*.

If a *Robot* is not present for a *Teamwork Match*, its *Preload* should be placed in that *Team's Load Zone*.

<SG6> Possession is limited to one (1) Bean Bag. *Possession* and *Plowing* are limited to one (1) *Bean Bag*. A *Robot* cannot have greater-than-momentary *Possession* of and/or *Plow* more than one *Bean Bag* at once. *Robots* that are interacting with multiple *Bean Bags* must immediately stop all *Robot* actions except for attempting to remove the excess *Bean Bag(s)*.

The intent of this rule is that each *Robot* should only interact with one *Bean Bag* at a time. *Robots* should not drive through *Bean Bags* on the *Field* while *Possessing* a *Bean Bag*, and cannot "*Plow*" one or more *Bean Bags* while already in *Possession* of a *Bean Bag*.

Momentary, incidental contact with a *Bean Bag* that results in minimal movement of the *Bean Bag* would not be considered *Plowing*. Greater than momentary contact with a *Bean Bag* that results in more significant movement of the *Bean Bag* (e.g., pushing a *Bean Bag* across a distance of 1 tile length or more) would generally be considered *Plowing*. The final determination of whether a *Bean Bag* has been *Plowed* will require some level of judgment from the *Head Referee*.

<SG7> Using the Load Zone. *Bean Bags* may be *Loaded* one at a time through the *Load Zone* during the *Match*, and must meet all of the following criteria.

- a. Red and blue *Bean Bags* may only be *Loaded* into the *Load Zone* that matches the color of that *Bean Bag*.
- b. The *Bean Bag* must be placed in contact with the *Floor*.
- c. The *Loader* may only put a *Bean Bag* into a *Load Zone* if no other *Bean Bags* are in contact with that *Load Zone*.
- d. A *Robot* may not contact a *Bean Bag* in the *Load Zone* if that *Bean Bag* is being contacted by a human.
- e. Once a *Bean Bag* is placed into a *Load Zone* and released, it may no longer be contacted by a *Loader* unless the *Head Referee* determines it was misloaded and must be retrieved as described in clause F.
- f. If a *Bean Bag* is introduced improperly (e.g., while another *Bean Bag* is in contact with the *Load Zone*), it must be retrieved by the *Loader* and reintroduced if the *Head Referee* instructs the *Loader* to do so.
- g. A *Loaded Bean Bag* must be placed in a stationary position, and must remain in contact with the *Floor* after it is released by the *Loader* until it is contacted by a *Robot*.
- h. *Bean Bags* that begin the *Match* outside the *Field* cannot break the plane of the *Field Perimeter* until the *Match* begins.

Note: Although it is not required, Robots are highly recommended to remain some distance away from the Bean Bag until the Loader's hand has clearly been removed. This will make clauses D & E abundantly clear to Head Referees.

This rule has additional Violation notes. See Appendix D.

Safety Rules

<S1> Stay safe, don't damage the Field. If, at any time, the *Robot* operation or *Team* actions are deemed unsafe or have damaged any *Field Elements* or *Scoring Objects*, the offending *Team* may be *Disabled* and/or *Disqualified* at the *Head Referee's* discretion. The *Robot* will require re-inspection before it may again take the *Field*.

Drive Team Members may not step onto the *Field* at any time, including pre-*Match* setup.

<S2> Students must be accompanied by an Adult. Every *Student* at a VEX IQ Robotics Competition event must be supervised by a responsible *Adult*. The *Adult* must obey all rules and be careful to not violate *Student-centered* policies, but must be present for the full duration of the event in the case of an emergency. *Violations* of this rule may result in removal from the event and additional penalties.

<S3> Each Student Team member must have a completed participant release form on file for the event and season. A *Student Team* member cannot participate in an event without a completed release form on file.

General Rules

<G1> Treat everyone with respect. All *Teams* and other attendees are expected to conduct themselves in a respectful and professional manner while participating in or attending VEX IQ Robotics Competition events. If a *Team* or any of its members (*Students* or anyone else associated with the *Team* or its members) are disrespectful or uncivil to event staff, volunteers, or fellow competitors, they may be *Disqualified* from a current or upcoming *Match*. *Team* conduct pertaining to <G1> may also impact a *Team's* eligibility for judged awards. Repeated or extreme *Violations* of <G1> could result in a *Team* being *Disqualified* from an entire event, depending on the severity of the situation.

- a. Event attendees are not allowed to record audio or video of *Teams'* discussions with *Head Referees* or other event staff/volunteers.

We all can contribute to creating a fun and inclusive event experience for all event attendees. Some examples include:

When dealing with difficult and stressful situations, it is...

- Okay for *Teams* to be gracious and supportive when your *Alliance* partner makes a mistake.
- Not okay for *Teams* to harass, tease, or be disrespectful to your *Alliance* partner when a *Match* does not go your way.

When a *Team* does not understand a *Match* ruling or score, it is...

- Okay for *Drive Team Members* to consult with a *Head Referee* to discuss a ruling per the process outlined in <T3> in a calm and respectful manner.
- Not okay for *Drive Team Members* to continue arguing with the *Head Referee* after a decision has been finalized, or for *Adults* to approach a *Head Referee* with ruling/scoring concerns.

When *Teams* are getting ready for an upcoming *Match*, it is...

- Okay for *Teams* in an *Alliance* to develop a game strategy that utilizes the strengths of both *Robots* to cooperatively solve the game.
- Not okay for one *Team* in an *Alliance* to ask another *Team* to sit in a corner during the *Match* or to intentionally play beneath their abilities.

<G2> VIQRC is a Student-centered program. *Adults* should not make decisions about the *Team's/Robot's* build, design, coding, documentation, or gameplay, and should not provide an unfair advantage by providing 'help' that is beyond the *Students'* independent abilities. *Students* must be prepared to demonstrate an active understanding of their design, *Robot* construction, programming, notebook, and strategies to judges or event staff. *Students* should build, design, and code the *Robot* with minimal *Adult* involvement.

If a *Team* has an engineering notebook, the format, layout, and contents should be created and maintained by *Students* with minimal *Adult* involvement; *Adults* should not transcribe or type notebook entries or code for *Students*.

Some amount of *Adult* mentorship, teaching, and/or guidance is an expected and encouraged facet of VEX competitions. No one is born an expert in robotics! However, obstacles should always be viewed as teaching opportunities, not problems for an *Adult* to solve for the *Team*.

When building or designing the *Robot*, it is...

- Okay for an *Adult* to help a *Student* consider why something failed, so it can be improved.
- Not okay for an *Adult* to provide step by step instructions or photos for the *Student* to copy.

When a mechanism falls off, it is...

- Okay for an *Adult* to help a *Student* consider why it failed, so it can be improved.
- Not okay for an *Adult* to investigate or put the *Robot* back together.

When a *Team* encounters a complex programming concept, it is...

- Okay for an *Adult* to guide a *Student* through a flowchart to understand its logic.
- Not okay for an *Adult* to write a premade command for that *Student* to copy/paste.

During *Match* play, it is...

- Okay for an *Adult* to provide cheerful, positive encouragement as a spectator.
- Not okay for an *Adult* to shout step-by-step commands from the audience.

This rule has additional Violation notes. See Appendix D.

<G3> Use common sense. When reading and applying the various rules in this document, please remember that common sense always applies in the VEX IQ Robotics Competition.

Some examples include:

- If there is an obvious typographical error (such as "per <T5>" instead of "per <GG5>"), this does not mean that the error should be taken literally until corrected in a future update.
- Understand the realities of the VEX IQ *Robot* construction system. For example, if a *Robot* could hover above the *Field* for a whole *Match*, that would create loopholes in many of the rules. But... they can't. So... don't worry about it.
- When in doubt, if there is no rule prohibiting an action, it is generally legal. However, if you have to ask whether a given action would violate <S1>, <G1>, or <T1> then that's probably a good indication that it is outside the spirit of the competition. On the other hand, if there's not a rule that makes a *Robot* part legal, it's not allowed.
- In general, *Teams* will be given the "benefit of the doubt" in the case of accidental or edge-case rules infractions. However, there is a limit to this allowance, and repeated or strategic infractions will still be penalized.

<G4> All work must represent the skill level of the Students on the Team. All work must represent the skill level of the *Students* currently on the *Team*. **Teachers, coaches, mentors, and peers can teach** concepts, skills, and processes; **demonstrate** techniques; **ask** guiding questions; review/critique the *Team's* work; and otherwise **advise** *Team* members. All final solutions used in competition (including the *Team's* design, *Robot*, code, strategies, documentation, and ongoing work) must be the work of the *Student Team* members. Organizations should develop a plan that encourages and empowers *Students* to make their own decisions (see <G2>).

- a. Designs and code provided by VEX Robotics:
 - i. *Teams* may use *Robot* plans and code (e.g., Hero Bots, VEXcode configurations, etc.) provided by VEX Robotics, but are encouraged to use these *Robots*, mechanisms, and code only as a starting point that *Students* modify, improve, or replace as their skills increase.
 - ii. Plans provided by VEX Robotics are the only legal plans available for use in competition.
- b. *Robot* design and construction:
 - i. *Teams* must avoid academic dishonesty and should not directly copy a *Robot* or mechanism other than those included in clause A. This includes, but is not limited to, the use of instructions, pictures, videos, notebooks, CAD designs, and/or any other documentation useful to the design process.
 - ii. *Teams* may be inspired by designs created by other *Teams*, and can use an idea from someone else to spark innovation, but are expected to clearly document and give credit to all ideas that are used for inspiration. The *Team* must describe how they made meaningful changes to the original idea to arrive at a design that is uniquely their own. It should be clear that this final implementation is not an exact copy of ANY other original design.
 - iii. *Teams* should demonstrate their design process in their engineering notebook, and provide it if asked to do so by event staff. Failure to demonstrate evidence of iteration, innovation, and/or modification will result in a *Violation*.
- c. *Robot* code:
 - i. *Teams* may use publicly available example code and/or custom libraries from outside sources. However, *Student Team* members must understand the resulting code, be able to explain all facets of their competition code, and be capable of independently creating code on a level equivalent to the code used on their *Robot* if asked to do so.
 - ii. *Teams* may not use Large Language Models, or similar forms of artificial intelligence (AI), to create or improve the code used in competition, as the resulting code does not reflect the skill level of the *Students* on the *Team*.
- d. Engineering notebook:
 - i. The *Team's* engineering notebook must be the work of the *Students* on the *Team*, and cannot be edited, formatted, or revised by anyone other than the *Students* on the *Team*.
 - ii. *Teams* may not use Large Language Models, or similar forms of AI, to create or improve the content of their engineering notebook.
 - iii. *Teams* can be inspired by engineering notebooks and formats from other *Teams* and/or seasons, but must ensure that all content is original and created by the members of the *Team*.

- e. Collaboration with other *Teams*:
 - i. *Teams* can collaborate on game analysis, brainstorming, strategy, and other steps of the engineering design process, but the final solutions used/presented at competitions must be the independent work of the *Students* on each *Team*.
 - ii. *Robots*, code, and/or engineering notebooks that are identical or substantially similar to one another across *Teams*, whether they're within the same school/organization/club or from separate organizations, are in *Violation* of this rule, regardless of whether they compete in the same or different events. Every *Team* is expected to put in the time, effort, and resources needed to undergo an independent design process and develop their own *Robots* and code.

Teams that use outside designs, instructions, code, and/or other materials instead of doing their own work undermine the core mission of the program: to provide *Students* with ownership of their work through hands-on opportunities to learn, design, and innovate.

While it is never our desire to punish *Students*, we must preserve the fairness, educational value, and integrity of the competition. Each *Team* must be able to explain and defend the design, construction, and programming of their *Robot* if questioned by event staff.

Event organizers cannot reasonably know the origins of every design or independently verify whether a *Robot* was created from scratch, purchased online, or copied from pictures of another *Team's* design. When questions of authenticity arise, the only direct and fair approach is to require *Students* to explain and defend their work (in conversation and through their engineering notebook if the *Team* has one), and *Students* should be prepared to describe their design process, justify design decisions, and demonstrate a full understanding of how their *Robot* and code function. This is not unlike academic honesty concerns in schools, and intellectual property concerns in business. By requiring *Students* to defend their designs, we ensure that they are developing not only technical skills, but effective communication skills and accountability as well. **If a *Team* is unable to provide reasonable evidence that their *Robot*, code, and documentation are the result of their own work, it is appropriate to assume that the *Team* is in Violation of <G2> and/or <G4>.** Consequences may include *Disqualification* from *Matches*, removal from events, and/or escalation of the investigation by VEX Robotics for further disciplinary action, which may include sanctions up to and including removal from the program.

Event staff should bear in mind <G3>, and use common sense when enforcing this rule. It is not the intent to actively hunt for *Violations* of this rule, compare every *Robot* at an event to all other known *Robot* designs, or closely question every *Team* at an event about their *Robot's* code. This rule is a set of tools for use if potential *Violations* are noted by or reported to event staff, and it is expected that most *Teams* will never be required to defend their *Robot* design or code.

Teams or individuals who deliberately weaponize, manipulate, or falsely report <G4> *Violations* for competitive gain or to harass another *Team* may be subject to a separate investigation. Misuse of this rule is considered a serious *Violation*.

This rule has additional Violation notes. See Appendix D.

<G5> Each Student can only belong to one Team. Each *Team* must include *Drive Team Members*, *Coder(s)*, *Designer(s)*, and *Builder(s)*. Many also include *Strategists* and *Notebooker(s)*. No *Student* may fulfill any of these roles for more than one VEX IQ Robotics Competition *Team* in a given competition season. *Students* may have more than one role on the *Team* (e.g., the *Designer* may also be the *Builder*, the *Coder*, and a *Driver*).

- a. *Team* members may only move from one *Team* to another for non-strategic reasons outside of the *Team's* control.
 - i. Examples of permissible moves may include, but are not limited to, changing schools, conflicts within a *Team*, or combining/splitting *Teams*.
 - ii. Examples of strategic moves in *Violation* of this rule may include, but are not limited to, one *Coder* "switching" *Teams* in order to program multiple *Robots*, one *Student* designing multiple *Teams' Robots*, or one *Student* writing the engineering notebook for multiple *Teams*.
 - iii. If a *Student* leaves a *Team* to join another *Team*, <G4> still applies to the *Students* remaining on the previous *Team*. For example, if a *Coder* leaves a *Team*, then that *Team's Robot* must still represent the skill level of the *Team* without that *Coder*. One way to accomplish this would be to ensure that the *Coder* teaches or trains a "replacement" *Coder* in their absence.
 - iv. Points ii and iii are intended to represent real-world situations that are found in industry engineering. If a vital member of a professional engineering team were to suddenly leave, the remaining members of the team should still be capable of working on / maintaining their project.
- b. When a *Team* qualifies for a championship event (e.g., States, Nationals, Worlds, etc.) the *Students* on the *Team* attending the championship event are expected to be the same *Students* on the *Team* that was awarded the spot. *Students* can be added as support to the *Team*, but may not be added as *Builders*, *Drivers*, *Coders*, or *Notebookers* for the *Team*.
 - i. An exception is allowed if only one (1) member of the *Team* is able to attend the event. The *Team* can make a single substitution of a *Driver* or *Coder* for the championship event with another *Student*, even if that *Student* has competed on a different *Team*. This *Student* will now be a member of this new *Team* and may not substitute back to the original *Team* during the season.

Note: Teams cannot "borrow" Students from other Teams to serve as Drive Team Members, Coders, Designers, Builders, or Notebookers. However, Teams can add permanent members throughout the season under the guidelines of this rule.

Event Partners should bear in mind <G3>, and use common sense when enforcing this rule. It is not the intent to punish a *Team* who may change *Team* members over the course of a season due to illness, changing schools, conflicts within a *Team*, etc.

Event Partners and referees are not expected to keep a roster of any *Student* who has ever been a *Driver* for one day. This rule is intended to block any instance of loaning or sharing *Team* members for the sole purpose of gaining a competitive advantage.

<G6> There is a difference between accidentally and willfully violating a Robot rule. Any *Violation* of *Robot* rules, accidental or intentional, will result in a *Team* being unable to play until they pass inspection (per <R2d>).

However, *Teams* who intentionally and/or knowingly circumvent or violate rules to gain an advantage over their fellow competitors are in *Violation* of the spirit and ethos of the competition.

General Game Rules

<GG1> Drivers drive your Robot, and stay in the Driver Station. During a *Match*, *Robots* may only be operated by that *Team's Drivers* and/or software running on the *Robot's* control system. Each *Team* may send up to three (3) *Drive Team Members* to their *Driver Station* for a *Match*: two (2) *Drivers*, and one (1) *Loader*. Those *Drive Team Members* must remain in their *Driver Station*, except when legally interacting with their *Robot* per <GG10>.

Drive Team Members are the only *Team* members that are allowed to be in the *Driver Station* during a *Match*. *Adults* (other than event staff) are not permitted to be in the *Driver Station* during a *Match*.

- a. *Drive Team Members* are prohibited from any of the following actions during a *Match*:
 - i. Using any sort of communication device in the *Driver Station*. Non-headphone devices with communication features turned off (e.g., a phone in airplane mode, a walkie talkie turned off, smart glasses with communication features disabled) are allowed. Communication features can be enabled for translation apps during post-*Match* discussions.
 - ii. Standing or sitting on any sort of object during a *Match*, regardless of whether the *Field* is on the *Floor* or elevated, except as required by an officially approved accommodation request.
 - iii. Bringing/using additional materials to simplify the game challenge during a *Match* (e.g., device to align or add *Scoring Objects* to the *Loader*).
 - iv. To ensure that *Drive Team Members* are aware of verbal calls during a *Match* (as an application of rules <T1>, <G1>, <S1>, and <G3>), powered headphones, earbuds, passive earpieces connected to electronic devices, or other personal accessories/devices that transmit audio cannot be worn/used in the *Driver Station* except as required by an officially approved accommodation request.
- b. In *Teamwork Matches*, one *Team* in an *Alliance* is assigned to the red *Driver Station* and the other *Team* is assigned to the blue *Driver Station*, as follows:
 - i. The *Team* listed as *Team 1* on a printed *Match* list, listed as red *Team* on events.vex.com, or listed first in VEXvia will use the red *Driver Station* and participate as the red *Team* in that *Match*.
 - ii. The *Team* listed as *Team 2* on a printed *Match* list, listed as blue *Team* on events.vex.com, or listed second in VEXvia will use the blue *Driver Station* and participate as the blue *Team* in that *Match*.
- c. Individuals who are not *Drive Team Members* for a *Match* cannot provide directions, commands, or advice to the *Drive Team Members* during that *Match*. They're welcome to provide cheerful, positive encouragement, but should not affect *Match* play or strategy.

Point iii is intended to refer to non-*Robot*-related items that directly influence gameplay. Provided no other rules are violated, and the items do not pose any safety or *Field* damage risks, the following examples are not considered *Violations* of <GG1>:

- Materials used before or after a *Match*, such as a pre-*Match* alignment aid
- Strategic aids, such as a whiteboard or clipboard
- Earplugs, gloves, or other personal accessories

This rule has additional Violation notes. See Appendix D.

<GG2> A Team's Robot should attend every Match. The *Team's Robot* must be in the *Driver Station* or on the *Field* for the *Team's* assigned *Match*, even if the *Robot* is not functional. If the *Robot* is not at the *Field* for the entire duration of the *Match*, that *Team* will be considered a "no show" and will receive zero (0) points. The other *Team* in the *Alliance* will still play and receive points for the *Match*.

- a. *Teams* are expected to participate in all scheduled *Qualification Matches* and, if they're ranked high enough to be included in a finals *Alliance*, *Finals Matches*. Failure to attend scheduled *Matches* may be considered a *Violation* of <G1>. *Teams* that participate in zero *Qualification Matches* cannot be considered for judged awards.

<GG3> Robots on the field must be ready to play. When a *Team* puts their *Robot* on the *Field*, it must be prepared to play (i.e., battery charged, sized within the starting size constraint, etc.).

- a. *Robots* must be placed on the *Field* promptly. Repeated failure to do so could result in a *Violation* of <G1> and/or removal of the *Robot* from the current *Match* at the *Head Referee's* discretion.
- b. If a *Robot* is delaying the scheduled start of a *Match*, it may be removed from the *Field* at the discretion of the *Head Referee* and *Event Partner*. The *Robot* may remain at the *Field* so that the *Team* does not get assessed a "no-show" (per <GG2>).
- c. If a *Robot* is not placed on the *Field* prior to the start of a *Match*, it cannot be placed on the *Field* during that *Match*.

The definition of the word "promptly" as used in clause A is at the discretion of the *Event Partner* and *Head Referee*, who will consider event schedule, previous *Violations* or delays, etc. As a general guideline, five seconds to check *Robot* alignment would be acceptable, but five minutes to assemble multiple parts together would not.

<GG4> Hands out of the Field. During a *Match*, *Drive Team Members* are prohibited from making intentional contact with any *Field Element*, *Robot*, or *Scoring Object* that has been introduced to the *Field*, except for the allowances in <GG10>, <RSC5>, and <SG7>.

- a. *Drive Team Members* are not permitted to reach into the 3-dimensional volume of the *Field Perimeter* at any time during the *Match*, apart from the actions described above. Rule <S1> applies.
- b. Any concerns regarding *Field Element* or *Scoring Object* starting positions should be raised with the *Head Referee* prior to the *Match*. *Team* members may never adjust *Scoring Objects* or *Field Elements* themselves.
- c. Transitive contact, such as contact with the *Field Perimeter* that causes the *Field Perimeter* to contact *Field Elements* or objects inside of the *Field*, could be considered a *Violation* of this rule.

If a *Drive Team Member's* hands extend over the *Field* and/or *Field Perimeter* in a way that is safe and doesn't contact anything in the *Field*, it's unlikely to be a *Violation*. However, *Head Referees* may still ask *Drive Team Members* to step back and remain completely outside the *Field* when necessary (e.g., for safety reasons or to reduce the chances of gameplay interference).

<GG5> Match Replays are allowed, but rare. *Match replays* (i.e., playing a *Match* over again from its start) must be agreed upon by both the *Event Partner* and *Head Referee*, and will only be issued in the most extreme circumstances. Some examples that may warrant a *Match* replay are as follows (note that this is not an exhaustive list):

- a. *Score Affecting "Field fault"* issues.
 - i. *Scoring Objects* not being reset before the *Match* starts.
 - ii. *Field Elements* detaching or moving beyond normal tolerances, not a result of *Robot* interactions.
- b. *Score Affecting* game rule issues.
- c. A *Field* is reset before the score is determined.
- d. A *Match* is run before its scheduled time without a *Team*.

<GG6> Disqualifications. A *Team* that is issued a *Disqualification* in a *Qualification Match* receives zero points for the *Match*. The other *Team* on their *Alliance* will still receive points for the *Match*.

- a. In *Finals Matches*, *Disqualifications* apply to the whole *Alliance*, not just one *Team*. An *Alliance* that receives a *Disqualification* in a *Finals Match* will receive zero points.
- b. A *Team* that receives a *Disqualification* in a *Robot Skills Match* will receive a score of zero.

<GG7> Time-outs. There are no time-outs in *VIQRC Tournaments*.

<GG8> Keep your Robot together. *Robots* may not intentionally detach parts or leave mechanisms on the *Field* during any *Match*.

- a. Parts that become unintentionally detached from the *Robot* are no longer considered to be part of the *Robot* and can be either left on the *Field* or collected by a *Drive Team Member* during a *Robot* reset using <GG10>.

<GG9> Don't damage the Field. *Robot* interactions which damage the *Field* or any *Field Elements* are prohibited. For the purpose of this rule, "damage" is defined as anything which requires repair in order to begin the next *Match*, such as causing part of a *Goal* to detach from the *Field*.

Teams are responsible for the actions of their *Robots* at all times, especially when interacting with the *Goals*. If a *Team* chooses to repeatedly ram full-speed into a *Field Element*, it will be hard to convince a *Head Referee* that any damage caused was "accidental."

This rule has additional Violation notes. See Appendix D.

<GG10> Handling the Robot mid-Match is allowed under certain circumstances. If a *Robot* goes completely outside the playing *Field*, gets stuck, tips over, or otherwise requires assistance, the *Drive Team Members* may retrieve & reset their *Robot* with the *Head Referee's* permission. To do so, the *Team* must do the following:

- a. Signal the Referee by placing their VEX IQ Controller on the ground. The *Head Referee* may ask the *Driver* to demonstrate the problem using the *Robot* controller before approving the *Robot* reset (e.g., confirming that the *Robot* is broken, undriveable, or stuck on an obstacle) if the issue with the *Robot* isn't obvious.
- b. Any *Scoring Objects* being controlled by the *Robot* while being handled must be removed from the *Field*, will not be returned to the *Field*, and cannot be reintroduced by the *Loaders*. No other *Scoring Objects* should be adjusted.
 - i. In the context of this rule, "controlled" implies that the *Robot* was manipulating the *Scoring Object*, and not simply touching it. For example, if the *Scoring Object* would move with the *Robot* either vertically or while turning, then the *Robot* is "controlling" that *Scoring Object*.
- c. The *Robot* must be placed back into a legal position that meets the criteria listed in clauses a,b, c, & d of <SG1>. If any *Scoring Objects* are preventing the *Robot* from being legally placed, they should be removed from the *Field*, will not be returned to the *Field*, and cannot be reintroduced by the *Loaders*. The *Robot* does not get a new *Preload* during this reset.
- d. Swapping one set of parts for another, or adding new pieces to a *Robot* mid-*Match* during a <GG10> or <RSC5> interaction is considered a *Violation* of the intent and spirit of this rule. Repairing a *Robot*, or reattaching parts of the *Robot* that unintentionally break off during a *Match*, is allowed.
- e. As described in rule <S1>, *Students* cannot step into the *Field* at any time during a *Match*. If the *Drive Team Members* cannot reach the *Robot* due to the *Robot* being in the center of the *Field*, they may ask the *Head Referee* to pick up the *Robot* and hand it to the *Drive Team Members* for placement according to the conditions above.

This rule has additional Violation notes. See Appendix D.

<GG11> A Team's two Drivers switch Controllers midway through the Match. In a given *Match*, up to two (2) *Drivers* may be in the *Driver Station* per *Team*. The two *Drivers* must switch their controller between thirty-five seconds (0:35 on the *Match* timer) and twenty-five seconds (0:25 on the *Match* timer) remaining in the *Match*.

- a. No *Driver* shall operate a *Robot* for more than thirty-five (35) seconds.
- b. The second *Driver* may not touch their *Team's* controls until the controller is passed to them.
- c. Once the controller is passed, the first *Driver* may no longer touch their *Team's* controls.
- d. A *Driver* cannot also be a *Loader* in the same *Teamwork Match*.
- e. If a drive team for a *Match* only has two members, one must serve as the *Driver* until the mid-*Match Driver* switch. The second *Drive Team Member* may serve as either the 2nd *Driver* (after the mid-*Match Driver* switch) or the *Loader* for the full *Match*, but cannot fill both roles. If the 2nd *Driver* position is unfilled, the *Robot's* operation (even prewritten commands) must cease after the first thirty-five (35) seconds of the *Match*.
- f. If only one *Drive Team Member* is present, the *Robot's* operation (even prewritten commands) must cease after the first thirty-five (35) seconds of the *Match* and the *Team* will not have a *Loader* during that *Match*.

This rule has additional Violation notes. See Appendix D.

<GG12> Don't start before the timer, and stop moving at the end of the Match. *Driver* inputs and *Robot* may not begin before the *Match* timer starts, and must cease at the end of the *Match*, when the timer reaches 0:00.

- Any scoring that takes place after a *Match* due to *Robots* continuing to move will not count toward the score.
- A pre-programmed routine which causes *Robot* motion to start before the *Match* or continue after the end of the *Match* would violate this rule.
- Any scoring that takes place after the end of a *Teamwork Match* is a *Violation*. Scoring that occurs after the end of a *Robot Skills Match* is not a *Violation*.

It is expected that many Level Up *Matches* will have last-second "buzzer-beater" moments. The key moment occurs when the timer display shows 0:00. At many events, a buzzer sound will also play at T=0:00; however, the *Field* timer display takes precedence in the event of any audio discrepancies.

If a *Scoring Object* is released from a *Robot* before this moment, it will be allowed to finish its path and the score will be calculated once it comes to rest. However, if it is released after this moment (i.e., the *Robot* was still moving past T=0:00) it will not count and the *Team* will receive a *Violation* as described below.

In cases where a last-second scoring attempt is "too close to call," *Teams* will generally be given the "benefit of the doubt" and the score will be counted. *Teams* are advised to place and release *Scoring Objects* a second or two before the timer reaches zero to avoid the need for referee judgment calls.

This rule has additional Violation notes. See Appendix D.

<GG13> Ending a Match early. If an *Alliance* wants to end a *Qualification Match* or a *Finals Match* early, both *Teams* must signal the referee by ceasing all *Robot* motion and placing their controllers on the ground. The referee will then signal to the *Teams* that the *Match* is over and will begin to tally the score. If the *Match* is a tiebreaker *Finals Match* for first place, then the *Match Stop Time* will also be recorded (see <T14b>).

<GG14> Drive Team Members are permitted to appeal the Head Referee's ruling immediately after a Match. If *Drive Team Members* wish to dispute a score or ruling, they must stay in the *Driver Station* until the *Head Referee* talks with them. The *Head Referee* may then choose to meet with the *Drive Team Members* at another location and/or at a later time so that the *Head Referee* has time to reference materials or resources to help with the decision. Once the *Head Referee* announces that their decision has been made final, the issue is over and no more appeals may be made (see rule <T1>); failure to accept this final decision may be considered a <G1> *Violation*.

- Referees are not permitted to review any photo or video *Match* recordings when determining a score or ruling. Some events may also prohibit *Drive Team Members* from reviewing photo or video *Match* recordings while in the *Driver Station*; this should be announced to all *Teams* before *Matches* start.
- Head Referees* are the only individuals permitted to explain a rule, *Disqualification*, or *Violation* to the *Teams* in a *Teamwork Match*. *Teams* should never consult other field personnel, including *Scorekeeper Referees*, regarding a ruling clarification.

Communication and conflict resolution skills are an important life skill for *Students* to practice and learn. In VEX IQ Robotics Competitions, we expect *Students* to practice proper conflict resolution using the proper chain of command. *Violations* of this rule may be considered a *Violation* of <G1>.

Some events may choose to utilize a "question box" or other designated location for discussions with *Head Referees*. Offering a "question box" is within the discretion of the *Event Partner* and/or *Head Referee*, and may act as an alternate option for asking *Drive Team Members* to remain in the *Driver Station* (although all other aspects of this rule apply).

However, by using this alternate location, *Drive Team Members* acknowledge that they are forfeiting the opportunity to use any contextual information involving the specific state of the *Field* at the end of the *Match*. For example, it is impossible to appeal whether a game element was scored or not if the *Field* has already been reset. If this information is pertinent to the appeal, *Drive Team Members* should still remain in the *Driver Station*, and only relocate to the "question box" once the *Head Referee* has been made aware of the concern and/or any relevant context.



vEX IQ
ROBOTICS
COMPETITION
LEVEL UP

2026 - 2027

Section 3 - Robot Skills Matches



Section 3 - Robot Skills Matches

Overview

In *Robot Skills Matches*, *Teams* have one minute to score as many points as possible. There are two types of *Robot Skills Matches*: *Driving Skills Matches*, which are entirely *Driver* controlled, and *Autonomous Coding Skills Matches*, which are autonomous with limited human interaction. *Teams* are ranked based on their combined score in the two types of *Robot Skills Matches*.

Robot Skills Matches are optional for all *Teams*. *Teams* who do not compete in *Robot Skills Matches* will not be penalized in *Teamwork Matches*. However, participation in *Robot Skills Matches* may impact eligibility for judged awards at the event.

At events that include *Teamwork Matches*, *Teams* may only participate in *Robot Skills Matches* if they also participate in the *Qualification Matches*. See rule <T15>.

Robot Skills Match Rules

<RSC1> Standard rules apply in most cases. All rules from previous sections apply to the *Robot Skills Matches*, unless otherwise specified in this section.

Violations of <GG>, <SG>, and <RSC> rules that occur during a *Robot Skills Match* should only affect the outcome of that *Match* and should not be considered when determining whether a *Violation* has been repeated during the event.

<RSC2> Scoring Robot Skills Matches. For each *Robot Skills Match*, *Teams* are awarded a score based on the standard scoring rules.

<RSC3> Robot and Field setup for Robot Skills Matches. The *Robot* and *Field* are set up the same as for *Teamwork Matches*, with the following modifications:

- a. The layout of *Scoring Objects* for a Level Up *Robot Skills Match* differs from the layout for *Teamwork Matches*, as shown in Figure RSC3-1.
 - i. Eight (8) *Bean Bags* (four red and four blue) begin the *Match* in the red *Driver Station* for *Loading*.
- b. The blue *Driver Station* and *Load Zone* are not used in *Robot Skills Matches*.
- c. The *Robot* must be placed in the starting position that shares a wall with the red *Pyramid Goal* at the beginning of the *Match* and after the *Robot* is reset under rule <GG10> or <RSC5>.

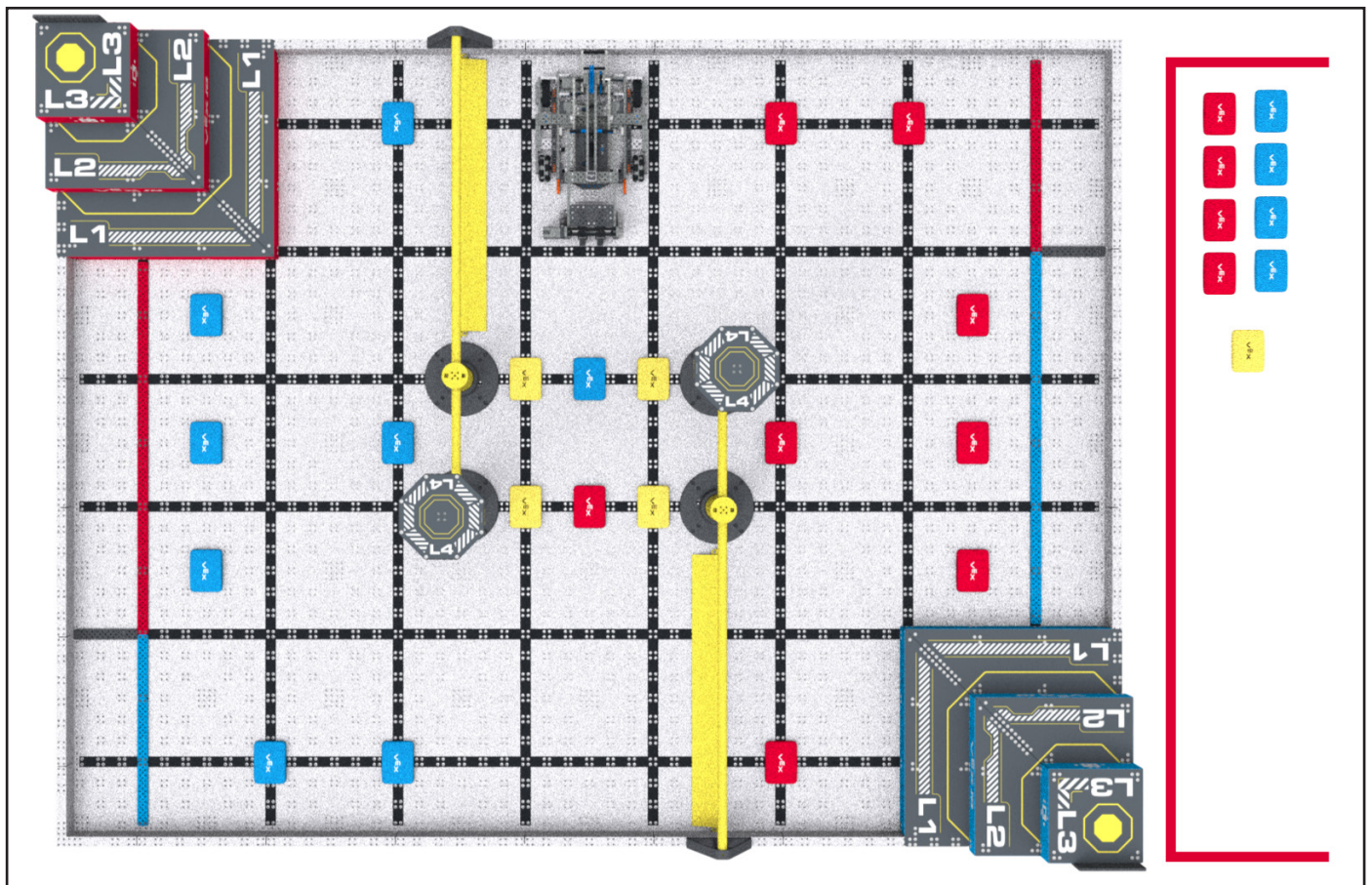

Figure RSC3-1: The field layout for a VIQRC Level Up Robot Skills Match.

<RSC4> Loader and Driver differences. All criteria listed in <SG7> apply as written (e.g., a *Loader* cannot put a *Scoring Object* into a *Load Zone* if there's already a *Scoring Object* there). *Loading* is modified as follows:

- In *Driving Skills Matches* and *Autonomous Coding Skills Matches*, any *Driver* who is not currently driving the *Robot* may also serve as a *Loader* (i.e., a *Team* may have one, two, or three *Loaders* at any given time).
- The blue *Load Zone* is not used in *Robot Skills Matches*. All *Match Loads* are *Loaded* through the red *Load Zone* in *Robot Skills Matches*.
- Drive Team Members* must remain in the red *Driver Station* during *Driving Skills Matches*, except when legally interacting with their *Robot* per rule <GG10>.
- During an *Autonomous Coding Skills Match*, *Drivers* may move freely around the *Field*, and are not restricted to the *Driver Station* when not handling their *Robot* under rule <RSC5>. This exception permits *Drivers* who wish to "stage" *Robot* handling during an *Autonomous Coding Skills Match* to do so without excessive running back and forth to the *Driver Station*.

<RSC5> Handling Robots during an Autonomous Coding Skills Match. A *Team* may handle their *Robot* as many times as desired during an *Autonomous Coding Skills Match*.

- a. Upon handling the *Robot*, it must be immediately brought back to a legal starting position. The *Robot* does not get a new *Preload Scoring Object* during this reset.
 - i. *Drive Team Members* may reset or adjust the *Robot* as desired from this position, including pressing buttons on the *Robot* brain or activating sensors.
 - ii. Any *Scoring Objects* that are *Possessed* by the *Robot* while being handled must be removed from the *Field*, will not be returned to the *Field*, and cannot be reintroduced by the *Loaders*. No other *Scoring Objects* should be moved or adjusted.
 - iii. As described in rule <S1>, *Students* cannot step into the *Field* at any time during a *Match*. If the *Drive Team Members* cannot reach the *Robot* due to the *Robot* being in the center of the *Field*, they may ask the *Head Referee* to pick up the *Robot* and hand it to the *Drive Team Members* for placement according to the conditions above.

This rule is an explicit exception to rule <GG4> and the *Violation Note* for <GG10>, and may be used as part of a *Team's* strategy for *Autonomous Coding Skills Matches*. *Driving Skills Matches* are still governed by <GG4> & the *Violation Note* for <GG10>, especially for strategic *Violations*.

<RSC6> Starting an Autonomous Coding Skills Match. *Drivers* must start a *Robot's* *Autonomous Coding Skills Match* routine by pressing a button on the *Robot* brain or manually activating a sensor. Because there is no VEX IQ Controller hand-off, only one *Driver* is required for an *Autonomous Coding Skills Match* (though *Teams* may still have two if desired).

- a. Pre-*Match* sensor calibration is considered part of the standard pre-*Match* setup time (i.e., the time when the *Team* would typically be turning on the *Robot*, moving any mechanisms to their desired legal start position, etc.).
- b. Pressing a button on the VEX IQ Controller to begin the routine is not permitted. To avoid any confusion, *Teams* are advised not to bring controllers to *Autonomous Coding Skills Matches*.

In accordance with <GG3>, *Teams* should be mindful of event schedules and set their *Robot* up as promptly as possible. The definition of "prompt" is at the discretion of the *Event Partner* and *Head Referee*, and could depend on things like how much time is left for the *Skills Challenge Field(s)* to be open, how many *Teams* are waiting in line, etc. As a general guideline, three seconds to calibrate a Gyro Sensor would be acceptable, but three minutes to debug a program would not.

<RSC7> Autonomous means "no humans." During an *Autonomous Coding Skills Match*, *Drive Team Members* are not permitted to activate any controls on their VEX IQ Controller, and cannot manually trigger sensors (including the Vision Sensor) in any way, even without touching them.

- a. *Teams* cannot use VEX IQ Controllers for any purpose in *Autonomous Coding Skills Matches*, and are advised not to bring controllers to the *Field*. If there is a controller at the *Field* during an *Autonomous Coding Skills Match*, it should be placed on the *Floor* outside the *Field* and remain untouched until after the *Match*.

<RSC8> Skills Stop Time. If a *Team* wishes to end their *Robot Skills Match* early, they may elect to record a *Skills Stop Time*. This is used as a tiebreaker for Robot Skills rankings. A *Skills Stop Time* does not affect a *Team's* score for a given *Robot Skills Match*. *Drivers* and field staff must agree prior to the *Match* on the signal that will be used to end the *Match* early.

- a. *Teams* who intend to attempt a *Skills Stop Time* must "opt-in" by verbally confirming with the *Scorekeeper Referee* prior to the *Robot Skills Match*. If no notification is given prior to the start of the *Match*, then the *Team* forfeits their option to record a *Skills Stop Time* for that *Match* and they will receive a default *Skills Stop Time* of 0.
 - i. This conversation should include informing the *Scorekeeper Referee* which *Driver* will signal the stop. The *Match* may only be ended early by a *Driver* for that *Match*.
 - ii. The agreed-upon signal to stop the *Match* must be both verbal and visual, such as *Drivers* crossing their arms in an "X" while saying "Stop!" or placing their VEX IQ Controller on the ground while saying "Done!"
 - iii. It is recommended that the *Driver* provides the *Scorekeeper Referee* with a verbal notice that the *Team* is approaching their intended *Skills Stop Time*, such as counting out "3-2-1-stop."
- b. The moment when the *Match* ends early is defined as the moment when the *Robot* and *Scoring Objects* have come to a rest and the *Driver* provides the agreed upon visual and audio signal to the *Scorekeeper Referee*.
 - i. If a Tournament Manager display is being used for field timing, then the *Skills Stop Time* is the time shown on the display when the *Match* is ended early (i.e., in 1-second increments).
 - ii. If a manual timer is being used that counts down to 0 with greater accuracy than 1-second increments, then the time shown on the timer should be rounded up to the nearest second. For example, if the *Robot* is *Disabled* and the timer shows 25.2 seconds, then the *Skills Stop Time* should be recorded as 26.
- c. If a *Team* runs multiple *Robot Skills Matches* in a row, they must reconfirm their *Skills Stop Time* choice with the *Scorekeeper Referee* prior to each *Match*.
- d. Any questions regarding a *Skills Stop Time* should be reviewed and settled immediately following the *Match*. <T1> and <T3> apply to *Robot Skills Matches*.



vEX IQ
ROBOTICS
COMPETITION
LEVEL UP

2026 - 2027
Section 4 - The Robot

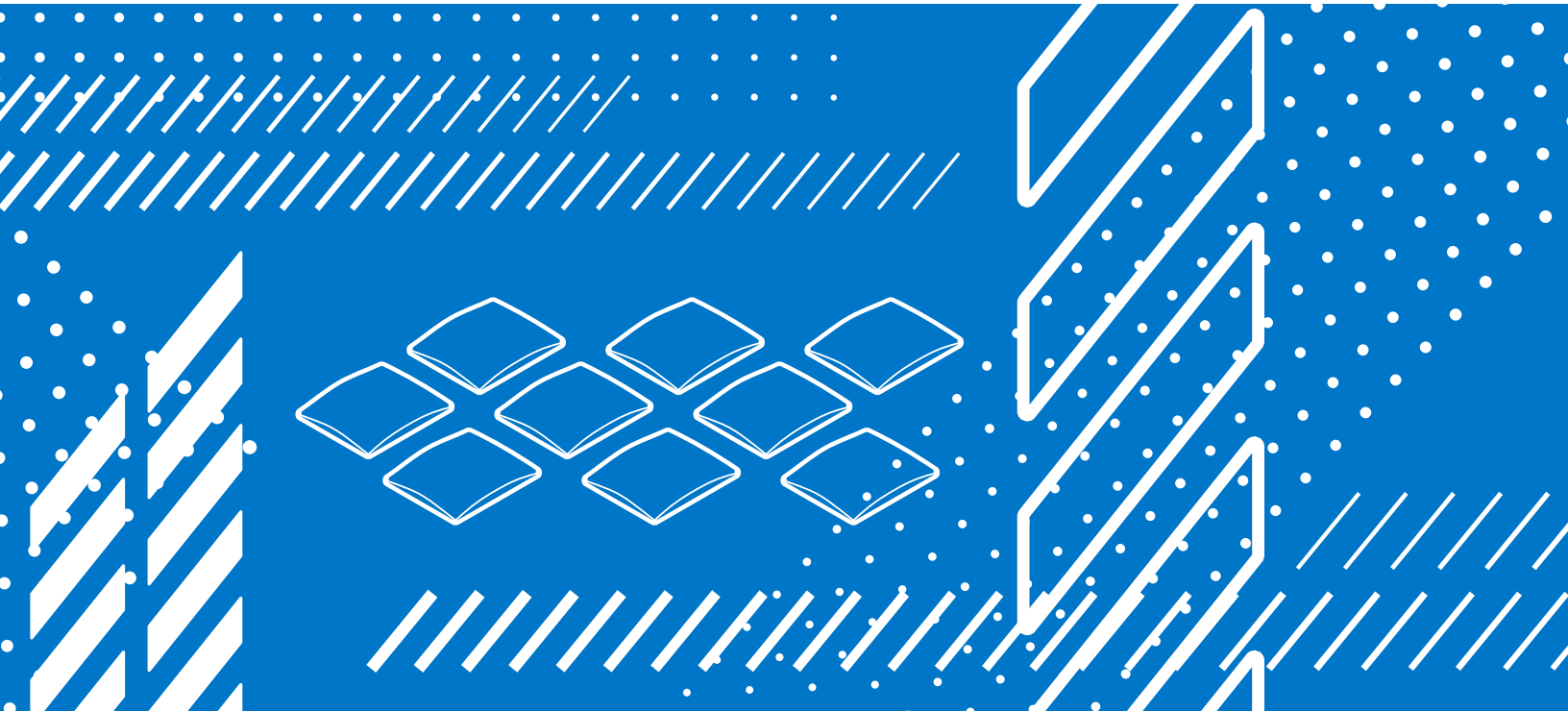

Section 4 - The Robot

Overview

Every *Robot* must pass a full inspection before being cleared to participate in the VEX IQ Robotics Competition. This inspection ensures that all *Robot* rules and regulations are met. Initial inspections will typically take place during *Team* check-in / practice time. Every *Team* should use the rules below as a guide to pre-inspect their *Robot* and ensure that it meets all requirements.

Most of these rules are “hard limits,” such as the maximum number of motors permitted. However, some are “at inspector discretion,” such as determining a mechanism’s potential safety risk. At many events, the lead inspector and the *Head Referee* are the same person; if they are not, then the volunteer inspector should work with the *Head Referee* to make any judgment calls. The *Head Referee* has final authority regarding all *Robot* rules, since it is ultimately their decision whether a *Robot* takes the *Field* for a *Match* after inspection has concluded (per <R2d> and <R2e>).

Comprehensive lists of legal and illegal VEX IQ Robotics Competition parts can be found in the [VEX IQ Robotics Competition Legal Parts](#) and [VEX IQ Robotics Competition Illegal Parts](#) supplements. These documents are updated as needed if/when new VEX IQ parts are released, and may not coincide with scheduled Game Manual updates.

Robot Summary

This summary checklist is not a replacement for the full *Robot* rules. *Teams* must still understand the rules in this section.

General requirements:

- ❑ Each *Team* can only bring one *Robot* to a competition <R1>
- ❑ The *Robot* must be designed, built, and coded by that *Team’s Student* members <G2>
- ❑ *Robots* can’t compete until they’ve passed inspection at the event <R2>
- ❑ The *Robot* has to fit within an 11”x20”x15” volume at the start of the *Match* <R3>

Required parts:

- ❑ One VEX IQ Robot Brain with current VEX IQ firmware <R8>
- ❑ Up to six (6) VEX IQ Robot Motors <R9>
- ❑ One VEX IQ Robot Battery <R10>
- ❑ One VEX IQ Robot Controller <R11>
- ❑ VEX IQ *Robot* components <R12>
- ❑ Two License Plates <R4>

Optional parts:

- ❑ Non-VEX rubber bands no larger than 7.5” long and 0.25” wide <R14a>
- ❑ HEXBUG mechanical and structural parts <R14d>
- ❑ VEX GO mechanical and structural parts <R14e>
- ❑ Food-safe lubricants used in moderation <R14i>
- ❑ Non-functional decorations that aren’t 3D printed <R15>

- VEX IQ pneumatics <R16>

Illegal parts:

- Modified parts (with 4 specific exceptions) <R17>
- Anything that could damage a person, Robot, *Field*, or game part <R13>
- Tape, stickers, etc. that aren't a non-functional decoration
- Any part that isn't specifically made legal by another rule
- Electronics from other VEX product lines
- 3D printed parts or decorations
- Everything listed in the illegal parts appendix

Inspection Rules

<R1> **One Robot per Team.** Each *Team* can only bring one *Robot* to a given event. Though it is expected that *Teams* will make changes to their *Robots* at the event, a *Team* is limited to only one *Robot*, and a given *Robot* may only be used by one *Team*. The VEX IQ system is intended to be a mobile robotics design platform. As such, a VEX IQ Robotics Competition *Robot*, for the purposes of the VEX IQ Robotics Competition, has the following subsystems:

- Subsystem 1: Mobile robotic base including wheels, tracks, or any other mechanism that allows the *Robot* to navigate the majority of the flat playing *Field* surface. For a stationary *Robot*, the robotic base without wheels would be considered Subsystem 1.
- Subsystem 2: Power and control system that includes a VEX IQ legal battery, a VEX IQ control system, and associated Smart Motors for the mobile robotic base. Also includes the VEX IQ pneumatic air pump and solenoids if used on the *Robot*.
- Subsystem 3: Additional mechanisms (and associated Smart Motors) that allow manipulation of *Scoring Objects* or navigation/manipulation of *Field Elements*.

Given the above definitions, a minimum *Robot* for use in any VEX IQ Robotics Competition event (including *Robot Skills Matches*) must consist of subsystems 1 and 2 above. Thus, if you swap out an entire subsystem 1 or 2, you have now created a second *Robot* and are no longer legal.

- Teams* may not compete with one *Robot* while a second is being modified or assembled at a competition.
- Teams* may not have an assembled second *Robot* on hand at a competition that is used to repair or swap parts with the first *Robot*.
- Teams* may not switch back and forth between multiple *Robots* during a competition. This includes using different *Robots* for *Robot Skills Matches*, *Qualification Matches*, and/or *Finals Matches*.
- Multiple *Teams* may not use the same *Robot*. Once a *Robot* has competed under a given *Team* number at an event, it is "their" *Robot*; no other *Teams* may EVER compete with it.

The intent of <R1a>, <R1b>, and <R1c> is to ensure an unambiguous level playing field for all *Teams*. *Teams* are welcome (and encouraged) to improve or modify their *Robots* between events, or to collaborate with other *Teams* to develop the best possible game solution.

However, a *Team* who brings and/or competes with two separate *Robots* at the same *Tournament* has diminished the efforts of a *Team* who spent extra design time making sure that their one *Robot* can accomplish all of the game's tasks. A multi-*Team* organization that shares a single *Robot* has diminished the efforts of a multi-*Team* organization that puts in the time, effort, and resources to undergo separate individual design processes and develop their own *Robots*.

To help determine whether a *Robot* is a "separate *Robot*" or not, use the subsystem definitions found in <R1>. Above that, use common sense as referenced in <G3>. If you can place two complete and legal *Robots* on a table next to each other, then they are two separate *Robots*. Trying to decide if changing a pin, a wheel, or a motor constitutes a separate *Robot* is missing the intent and spirit of this rule. Rules <G4> and <R2> still apply to both *Robots*.

<R2> Robots must pass inspection. The *Team's Robot* must pass inspection before being allowed to participate in any *Matches*. Noncompliance with any *Robot* design or construction rule will result in removal from *Matches* or *Disqualification* of the *Robot* at an event until the *Robot* is brought back into compliance, as described in the following subclauses.

- a. Significant changes to a *Robot*, such as a partial or full swap of Subsystem 3, must be re-inspected before the *Robot* may compete again.
- b. All possible functional *Robot* configurations must be inspected before being used in competition. This especially pertains to modular or swappable mechanisms (per <R1>) and *Match* starting configurations/sizes (per <R3>).
- c. *Teams* may be asked to submit to spot inspections by *Head Referees*. Refusal to submit will result in *Disqualification*.
- d. If a *Robot* is determined to not be legal before a *Match* begins and cannot be brought into compliance before the scheduled *Match* start time, the *Robot* will be removed from the *Field*. The *Robot* may remain at the *Field* so that the *Team* does not get assessed a "no-show" (per <GG2>).
- e. *Robots* which have not passed inspection (i.e., that are in *Violation* of one or more *Robot* rules) will not be permitted to play in any *Matches* until they have done so. <GG2> will apply to any *Matches* that occur until the *Robot* has passed inspection.
- f. If a *Robot* has passed inspection, but is later found to be in *Violation* of a *Robot* rule during or immediately following a *Match*, then they will be *Disqualified* from that *Match* and <R2d>/<GG3> will apply until the *Violation* is remedied and the *Team* is re-inspected. This is the only *Match* that will be affected; any prior *Matches* that have already been completed will not be revisited. <R2d> will apply until the *Violation* is remedied and the *Team* is re-inspected.
- g. All inspection rules are to be enforced at the discretion of the *Head Referee* within a given event. *Robot* legality at one event does not automatically imply legality at future events. *Robots* which rely on "edge-case" interpretations of subjective rules, such as whether a decoration is "non-functional" or not, should expect additional scrutiny during inspection.
- h. Event staff and volunteers are allowed to contact and/or photograph *Robots* during inspection and/or at other times as needed.

<R3> Robots must fit within an 11" x 20" x 15" (279.4mm x 508mm x 381.0mm) volume during inspection and at the start of each *Match*.

- a. *Teams* using more than one possible *Robot* configuration must tell the inspector(s) and have the *Robot* inspected in all configurations. Rule <R2c> will apply if a *Robot* is placed in an uninspected configuration (i.e., will not be permitted to play until re-inspected, but will not be considered a "no-show").

A *Team* may NOT have its *Robot* inspected in one configuration and then place it in an uninspected configuration at the start of a *Match*.

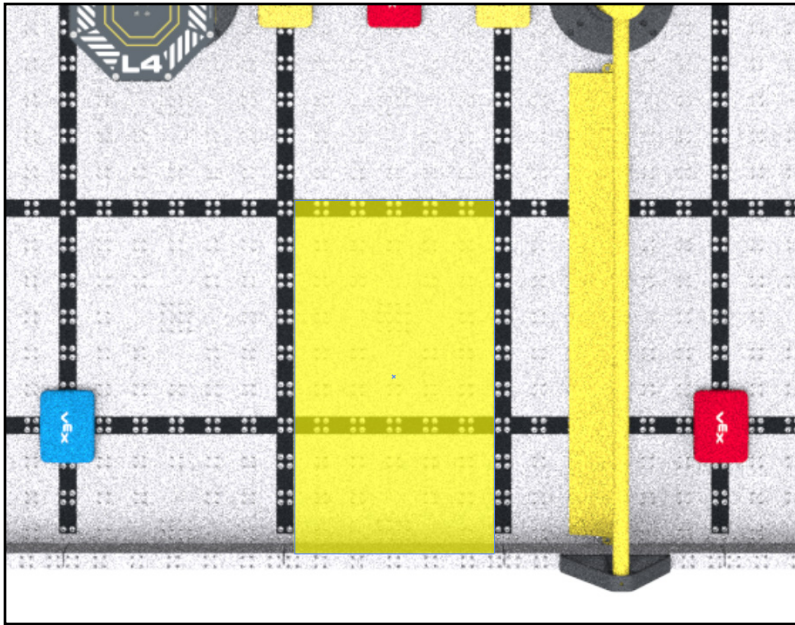

Figure R3-1: The approximate size limit for a *Robot* at the start of a *Match* (highlighted in yellow).

<R4> License Plates. Officially registered *Team* numbers must be legibly displayed on exactly two *Robot License Plates* that are mounted on opposing sides of the *Robot*. *Teams* may use the official VEX IQ Robotics Competition *License Plate* (VEX Part Number 228-7401) or a plain paper version of matching size (3.5" x 1.5" / 88.9mm x 38.1mm).

- a. *License Plates* are considered functional components, and must meet the requirements of all other *Robot* rules.
- b. *License Plates* must be clearly visible at all times. For example, *License Plates* must not be in a position that would be easily obstructed by a *Robot* mechanism during standard *Match* play.
- c. Additional *License Plates* cannot be used on the *Robot* for any purpose.

This rule has additional Violation notes. See Appendix D.

Figure R4-1: A VEX IQ Robotics Competition License Plate with a VEX IQ Robotics Competition Team number written upon it.

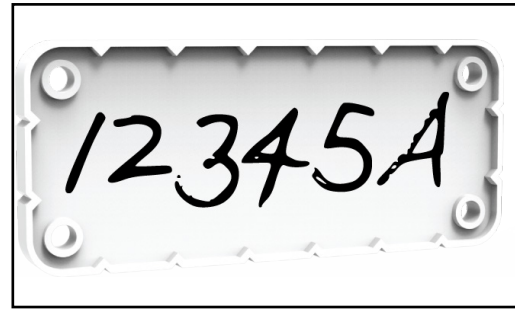

<R5> Let it go after the Match is over. Robots must be designed to permit easy removal of Scoring Objects from their Robot without requiring that the Robot have power or remote control after the Match is over.

<R6> Robots have one Brain. Robots are limited to one VEX IQ Robot Brain. Any other microcontrollers or processing devices are not allowed, even as non-functional decorations.

This includes microcontrollers that are part of other VEX product lines, such as VEX Cortex, VEX EXP, VEXpro, VEX CTE, VEX RCR, VEX V5, VEX GO, or VEX Robotics by HEXBUG*. This also includes devices that are unrelated to VEX, such as Raspberry Pi or Arduino devices.

- a. If using a first generation VEX IQ Brain, Robots must use one VEX IQ 900 MHz radio, VEX IQ 2.4 GHz radio, or VEX IQ Smart Radio in conjunction with their VEX IQ Robot Brain. The VEX IQ Brain and VEX IQ Controller may not be physically connected during a Match, and may only communicate through the radio.
- b. Additional Robot Brains cannot be used on the Robot (even Robot Brains that are not connected).

<R7> Keep the power button accessible. The on/off button on the VEX IQ Robot Brain must be accessible without moving or lifting the Robot. All screens and/or lights must also be easily visible by competition personnel to assist in diagnosing Robot problems.

This rule is in place to ensure the safety of both competitors and Field staff. In the event that a Robot needs to be quickly powered off—whether due to a malfunction, entanglement, or other safety concern—it is crucial that the power button remains easily accessible. This allows competitors and/or Field personnel to safely Disable the Robot without putting their hands near moving parts or other hazards inside the Robot. Additionally, keeping screens and indicator lights visible helps officials diagnose issues efficiently, minimizing downtime and ensuring a smooth competition experience.

<R8> Firmware. Teams must use VEXos version 2.2.1 or newer on Gen1 Brains, or VEXos version 1.0.8 or newer on Gen2 Brains. The latest firmware can be found at <https://link.vex.com/firmware>. Custom firmware modifications are not permitted.

- a. The minimum version requirement is subject to change over the course of the season.
- b. When the minimum version is updated, Teams have a two week (14 calendar day) grace period from the time the minimum version is changed to update their firmware to the latest minimum version.
- c. VEX Robotics reserves the right to deem any firmware update critical, and remove the allowable grace period.

<R9> Motors. Robots may use up to six VEX IQ Smart Motors.

- a. Additional motors cannot be used on the *Robot* (even motors that aren't connected).

<R10> Batteries. The only allowable sources of electrical power for a VEX IQ Robotics Competition Robot are one VEX IQ Robot Battery (first or second generation) or six AA batteries via the Robot AA Battery Holder (228-3493).

- a. Additional batteries cannot be used on the *Robot* (even batteries that aren't connected).
- b. *Teams* are permitted to have an external power source (such as a rechargeable battery pack) plugged into their VEX IQ Controller during a *Match*, provided that this power source is connected safely and does not violate any other rules (such as <GG1>).

Note: Although it is legal, the Robot AA Battery Holder (228-3493) is not recommended for use in the VEX IQ Robotics Competition.

<R11> One Controller per Robot. No more than one VEX IQ Controller may control a single *Robot*.

- a. No physical or electrical modification of the Controller is allowed under any circumstances.
 - i. Attachments which assist the *Drivers* in holding or manipulating buttons/joysticks on the IQ Controller (including 3D-printed controller attachments) are permitted, provided that they do not involve direct physical or electrical modification of the Controller itself.
- b. No other methods of controlling the *Robot* (light, sound, etc.) are permissible.
 - i. Using sensor feedback to augment *Driver* control (such as motor encoders or the Vision Sensor) is permitted.
 - ii. See <RSC5>, <RSC6>, and <RSC7> for more information about operating the *Robot* during *Autonomous Coding Skills Matches*.

<R12> Robots are built from the VEX IQ product line. Robots may be built ONLY from official *Robot* components from the VEX IQ product line, unless otherwise specifically noted within these rules.

- a. Official VEX IQ products are ONLY available from VEX Robotics. To determine whether or not a product is "official" and legal for competition use, consult the following sources:
 - i. [VEX IQ Robotics Competition Legal Parts Appendix](#)
 - ii. [VEX IQ Robotics Competition Illegal Parts Appendix](#)
 - iii. www.vexiq.com
- b. If an inspector or *Head Referee* questions whether something is an official VEX IQ component, the *Team* will be required to provide documentation that proves the component's source. Such documentation may include receipts, part numbers, or other printed documentation.
- c. Only VEX IQ components specifically designed for use in *Robot* construction are allowed. Using additional components outside their typical purpose is against the intent of the rule (i.e., please don't try using VEX IQ apparel, *Team* or event support materials, packaging, *Field Elements*, or other non-*Robot* products on a VEX IQ Robotics Competition *Robot*).

- d. Official robotics components from the VEX IQ product line that have been discontinued are still legal for *Robot* use. However, *Teams* must be aware of <R12b>.
- e. Additional VEX IQ products that are released during the season are legal for use, unless otherwise noted on their product pages.
- f. VEX IQ Smart Cables may only be used for connecting legal electronic devices to the VEX IQ Robot Brain.

Note: A comprehensive list of legal VEX IQ parts can be found in the VEX IQ Robotics Competition Legal Parts Appendix, at <https://link.vex.com/docs/viqrcl/legal-parts>. This Appendix is updated as needed if/when new VEX IQ parts are released, and may not coincide with scheduled Game Manual updates.

<R13> Prohibited items. The following types of mechanisms and components are NOT allowed:

- a. Those that could potentially damage *Field Elements* or *Scoring Objects*.
- b. Those that could potentially damage or entangle other *Robots*.
- c. Tape and/or any other material that adheres to or changes a legal part, other than for labeling hardware as permitted by <R14h> or non-functional decorations as permitted by <R15>.
- d. Products from the VEX 123, VEX V5, VEX CTE, VEX EXP, Cortex, or VEXpro product lines, unless specifically allowed by a clause of <R14>.
- e. Electrical components from the VEX Robotics by HEXBUG* product line.
- f. Electrical components from the VEX GO product line.
- g. 3D printed parts for any purpose, including *License Plates*, License Plate holders, and non-functional decorations.
- h. Additional illegal parts are listed in the VEX IQ Robotics Competition Illegal Parts Appendix, at <https://link.vex.com/docs/viqrcl/illegal-parts>. This Appendix is updated as needed, and may not coincide with scheduled Game Manual updates.

<R14> Legal Non-VEX IQ components. *Robots* are allowed to use the following additional components from sources other than VEX Robotics:

- a. Rubber bands no larger than 7.5" long and 0.25" wide.
- b. 1/8" metal shafts from the VEX V5 product line.
- c. Other products from the VEX V5 product line that are also cross-listed as part of the VEX IQ product line are legal. A "cross-listed" product is one which can be found in both the VEX IQ and VEX V5 sections of the VEX Robotics website.
- d. Mechanical/structural components from the VEX Robotics by HEXBUG* product line are legal for *Robot* construction.
- e. Mechanical/structural components from the VEX GO product line are legal for *Robot* construction.
- f. Aerosol-based cooling/freeze spray may be used to assist in cooling motors. *Teams* using freeze spray or similar products in ways that may reasonably be deemed unsafe could be subject to <S1> *Violations*.

- g. Cleaners, disinfectants, and/or sanitizers may be used to assist in cleaning *Robots*, parts, components, etc. VEX Robotics recommends [these procedures](#) for cleaning/disinfecting/sanitizing *Robot* parts.
- h. A limited amount of tape is allowed for the sole purpose of labeling motors, Robot Brains, and/or controllers.
- i. Food-safe lubricants (grease, oils, or other lubricants) may be used on *Robots*, provided they are used in moderation and can not contaminate the *Field*, other *Robots*, *Field Elements*, and/or *Scoring Objects*.

* The HEXBUG brand is a registered trademark belonging to Spin Master Corp

<R15> Decorations are allowed. *Teams* may add non-functional decorations, provided that they do not affect *Robot* performance in any significant way or affect the outcome of the *Match*. These decorations must be in the spirit of the competition. Inspectors and *Head Referees* will have final say in what is considered “non-functional.” Unless otherwise specified below, non-functional decorations are governed by all standard *Robot* rules.

- a. Decorations must be in the spirit of an educational competition.
- b. To be considered “non-functional,” any decorations must be backed by legal materials that provide the same functionality. For example, a giant decal cannot be used to prevent *Scoring Objects* from falling out of the *Robot* unless it is backed by VEX IQ material. A simple way to check this is to determine if removing the decoration would impact the performance of the *Robot* in any way.
- c. The use of non-toxic paint is considered a legal non-functional decoration. However, any paint used as an adhesive or to impact how tightly parts fit together would be classified as functional.

Teams should be mindful of any non-functional decorations which could risk “distracting” an *Alliance* partner *Robot*’s Vision Sensor or other sensors.

<R16> Pneumatics. *Robots* using parts from the VEX IQ Pneumatics Kit (228-8795) must satisfy all of the following criteria:

- a. No more than two Air Tanks, including any that aren’t connected.
- b. No more than one Air Pump, including any that aren’t connected.
- c. No additional parts that are not included in the VEX IQ Pneumatics Kit (e.g., unofficial tubing or fittings).
- d. *Teams* may not use other elements for the purposes of storing or generating air pressure, and cannot use Pneumatic Cylinders or additional tubing solely for additional air storage. *Robots* are limited to the air pressure stored in two Air Tanks, as well as the normal working air pressure contained in any Pneumatic Cylinders and tubing on the *Robot*.
- e. *Teams* can only use Pneumatic Cylinders and/or tubing as part of an actual pneumatic system (e.g., Air Tanks and/or an Air Pump).

There is no limit on the number of Pneumatic Cylinders or Pneumatic Solenoids that may be used, provided that no other rules are violated. There are no restrictions on running the Air Pump prior to (or during) *Matches*.

<R17> Modifications of parts. Parts may NOT be modified unless specifically listed as an exception in this rule. Examples of illegal modifications include, but are not limited to, bending, cutting, sanding, gluing, lubricating, taping, and melting. The following exceptions are the only legal modifications of parts:

- a. Cutting metal VEX IQ or VEX V5 shafts to custom lengths.
- b. Bending parts which are intended to be flexible, such as string, rubber bands, or thin plastic sheets.
- c. Cutting VEX IQ pneumatic tubing to custom lengths.
- d. Tying knots to shorten or connect string or rubber bands.



vEX IQ
ROBOTICS
COMPETITION
LEVEL UP

2026 - 2027
Section 5 - The Event

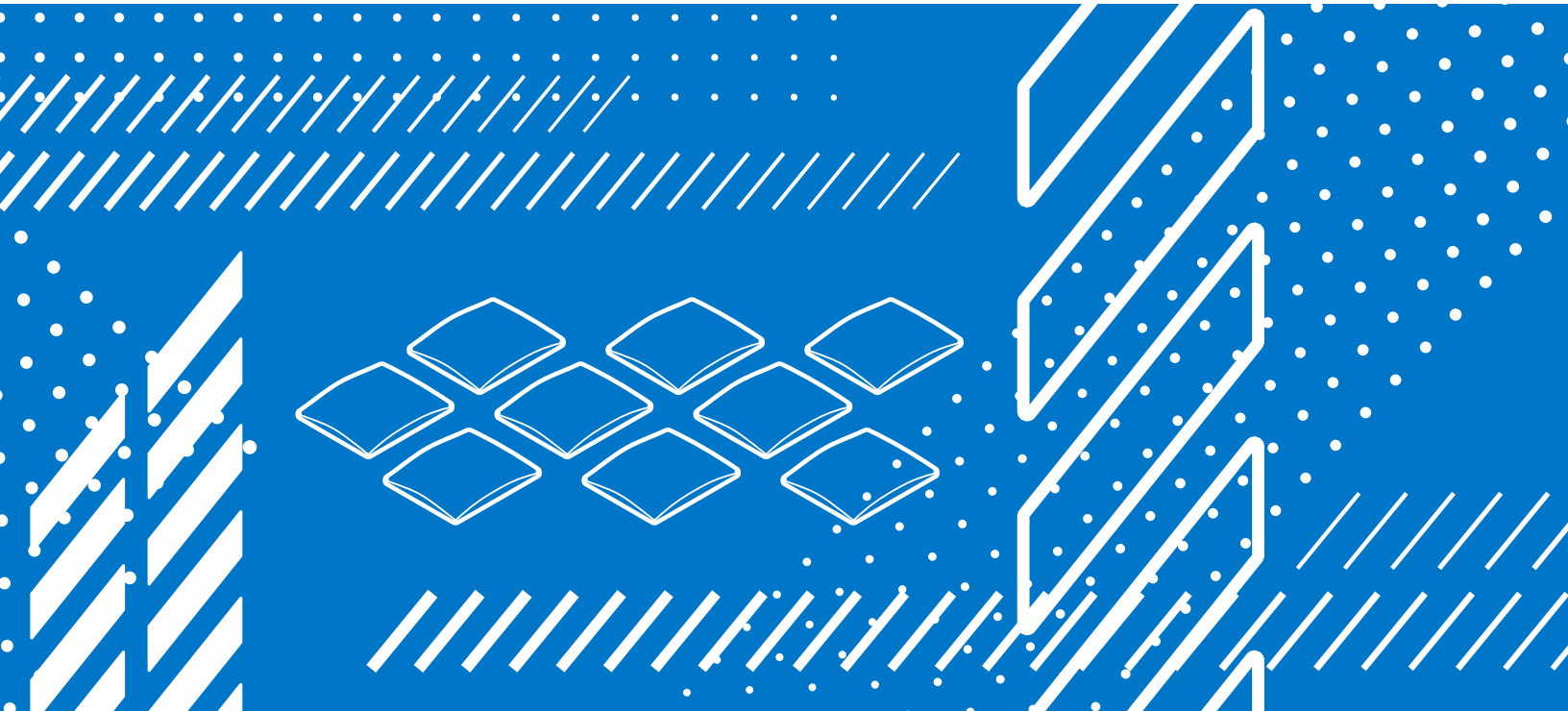

Section 5 - The Event

Overview

The VEX IQ Robotics Competition consists of *Teamwork Matches*, *Robot Skills Matches*, and optional judging. This section describes how *Teamwork Matches* and *Robot Skills Matches* are to be played at a given event.

Awards may be given to top *Teams* in each format, as applicable. Awards may also be given for overall performance in the judged criteria.

Inspection Rules

<T1> Head Referees have ultimate and final authority on all gameplay and Robot ruling decisions during the competition. *Head Referees* are the only individuals permitted to explain a rule, *Disqualification*, or *Violation* to the *Teams* in a *Teamwork Match*.

- a. *Scorekeeper Referees* score the *Match*, and may serve as observers or advisers for the *Head Referees*, but may not determine any *Violations* directly.
- b. When issuing a *Disqualification* or *Violation* to a *Team*, the *Head Referee* should attempt to notify the *Team* as the *Violation* occurs, and after the *Match* must provide the rule number of the specific rule that has been *Violated* and record the *Violation* in the *Match Anomaly Log*.
- c. *Event Partners* may not overrule a *Head Referee's* gameplay or *Robot* decisions.
- d. Every *Qualification Match* and *Finals Match* must be watched by a certified *Head Referee*. A *Head Referee* may only watch one *Match* at a time; if multiple *Matches* are happening simultaneously on separate *Fields*, each *Field* must have its own *Head Referee*.
- e. At a minimum, every *Robot Skills Match* must be watched by a trained *Scorekeeper Referee*, who may only watch one *Match* at a time. If multiple *Robot Skills Matches* are happening simultaneously on separate *Fields*, each *Field* must have its own *Scorekeeper Referee*. A certified *Head Referee* must be available at the event to explain a rule, *Disqualification*, *Violation*, or other penalty to *Teams* in *Robot Skills Matches* as needed in support of the *Scorekeeper Referees* at skills *Fields*.
- f. *Head Referees* must follow the rules in this game manual and the Q&A, and must make rulings consistent with the intent of the game manual and Q&A.
- g. Referees are not permitted to review any photo or video *Match* recordings when determining a score or ruling.

Note from the VEX Game Design Committee: The rules contained in this Game Manual are written to be enforced by human *Head Referees*. Many rules have clear "black-and-white" criteria that can be easily checked. However, some rulings will rely on a judgment call from this human *Head Referee*. In these cases, *Head Referees* will make their calls based on what they and the *Scorekeeper Referees* saw, what guidance is provided by their official support materials (this Game Manual and the Q&A), and most crucially, the context of the *Match* in question.

The VEX IQ Robotics Competition does not have video replay, our *Fields* do not have absolute sensors to count scores, and events do not have time for extensive review conferences between each *Match*.

When an ambiguous rule results in a controversial call, there is a natural instinct to wonder what the “right” ruling “should have been,” or what the *Game Design Committee* “would have ruled.” This is ultimately an irrelevant question; our answer is that when a rule specifies “*Head Referee’s discretion*” (or similar) the correct call is the one that was made by the *Head Referee* in the moment. The VEX *Game Design Committee* designs games, and writes rules, with this expectation (constraint) in mind.

<T2> Head Referees must be qualified. VEX IQ *Head Referees* must have all of the following qualifications:

- a. Be at least 16 years of age.
- b. Be approved by the *Event Partner*.
- c. Be a certified VIQRC *Head Referee* for the current season.
- d. Cannot be the *Event Partner* or a Judge Advisor for the event.

Note: Scorekeeper Referees must be at least 15 years of age, and must be approved by the Event Partner.

<T3> The Drive Team Members are permitted to immediately appeal the Head Referee’s ruling. If *Drive Team Members* wish to dispute a score or ruling, they must stay in the *Driver Station* until the *Head Referee* talks with them. The *Head Referee* may then choose to meet with the *Drive Team Members* at another location and/or at a later time so that the *Head Referee* has time to reference materials or resources to help with the decision.

Once the *Head Referee* announces that their decision has been made final, the issue is over and no more appeals may be made (see rule <T1>); failure to accept this final decision may be considered a <G1> *Violation*. There is no system or opportunity for an appeal of the *Head Referee’s* final decision, either at or after the event.

- a. Referees are not permitted to review any photo or video *Match* recordings when determining a score or ruling. Some events may also prohibit *Drive Team Members* from reviewing photo or video *Match* recordings while in the *Driver Station*; this should be announced to all *Teams* before *Matches* start.
- b. *Head Referees* are the only individuals permitted to explain a rule, *Disqualification*, or *Violation* to the *Teams* in a *Teamwork Match*. *Teams* should never consult other field personnel, including *Scorekeeper Referees*, regarding a ruling clarification.

Communication and conflict resolution skills are an important life skill for *Students* to practice and learn. In the VEX IQ Robotics Competition, we expect *Students* to practice proper conflict resolution using the proper chain of command. *Violations* of this rule may be considered a *Violation* of <G1>

Some events may choose to utilize a “question box” or other designated location for discussions with *Head Referees*. Offering a “question box” is within the discretion of the *Event Partner* and/or *Head Referee*, and may act as an alternate option for asking *Drive Team Members* to remain in the *Driver Station* (although all other aspects of this rule apply).

However, by using this alternate location, *Drive Team Members* acknowledge that they are forfeiting the opportunity to use any contextual information involving the specific state of the *Field* at the end of the *Match*. For example, it is impossible to appeal whether a game element was scored or not if the *Field* has already been reset. If this information is pertinent to the appeal, *Drive Team Members* should still remain in the *Driver Station*, and only relocate to the "question box" once the *Head Referee* has been made aware of the concern and/or any relevant context.

<T4> The Event Partner has ultimate authority regarding all non-gameplay decisions during an event.

The Game Manual is intended to provide a set of rules for successfully playing VEX IQRC Level Up; it is not intended to be an exhaustive compilation of guidelines for running a VEX IQ Robotics Competition event. Rules such as, but not limited to, the following examples are at the discretion of the *Event Partner* and should be treated with the same respect as this Game Manual:

- Venue access
- Pit spaces and access
- Health and safety
- *Team* registration and/or competition eligibility
- *Team* conduct away from competition *Fields*

This rule exists alongside <G1>, <S1>, and <G3>. Even though there isn't a rule that says "do not steal from the concession stand," it would still be within an *Event Partner's* authority to remove a thief from the competition.

<T5> Be prepared for minor field variance. *Field Element* tolerances and *Scoring Object* positions may vary from nominal by up to $\pm 0.5"$ [12.7mm], unless otherwise specified. *Teams* are encouraged to design their *Robots* accordingly. Please make sure to check Appendix A for more specific nominal dimensions and tolerances.

The *Field* and *Field Elements* are designed to be assembled and disassembled multiple times each year. *Event Partners* store and transport *Fields* between events, and the individuals setting up the *Field* at one event may differ from those at the next. While every effort will be made to ensure minimal variance, *Teams* should expect that any *Field* may be slightly different than another, and prepare accordingly. Just because something works on one *Field* does not fully guarantee it will work on the next, and is not enough evidence alone to determine if a *Field* is out of tolerance.

<T6> Fields and Field Elements may be repaired at the Event Partner's discretion. All competition *Fields* and other *Field Elements* at an event must be set up in accordance with the specifications in Appendix A and/or other applicable support materials. Minor aesthetic customizations or repairs are permitted, provided that they do not impact gameplay (see <T4>).

Examples of permissible modifications include, but are not limited to:

- Replacing a damaged or missing VEX IQ component with an identical part of any color
- Elevating the playing *Field* off of the floor (common heights are 10" to 24" [254mm to 609.6mm])
- Using off-the-shelf PVC to replace a damaged or missing pipe
- Small markings on *Field Elements* and *Scoring Objects* to identify ownership
- Placing *Field* display monitors outside of the *Field* walls
- Adding decorations to the outside of the *Field* walls or risers (e.g., LED lights, sponsor banners)

Modifications that may impact *Robot* functionality and/or how the game is played are generally not allowed. Examples of prohibited modifications include, but are not limited to:

- Unofficial *Field Floor* and/or walls, additional structural elements inside of the *Field*, or unofficial/replica *Field Elements*
- Significant/large markings on *Scoring Objects* that could positively or negatively affect *Robot* sensors

Any specific repairs and/or modifications which pertain to the current season's game will be documented in this rule and Appendix A, as needed.

<T7> Fields at an event must be consistent with each other. There are many types of permissible aesthetic and/or logistical modifications that may be made to competition *Fields* at the *Event Partner's* discretion (see <T6>). If an event has multiple *Teamwork Match Fields*, they must all incorporate the same permissible modifications. If an event has multiple *Robot Skills Match Fields*, they must all incorporate the same permissible/applicable modifications. For example, if one *Teamwork Match Field* is elevated, then all *Teamwork Match Fields* must be elevated to the same height.

Note: If an event has dedicated Fields for Robot Skills Matches, there is no requirement for them to have the same consistent modifications as the Teamwork Match Fields. See <T16> for more details.

<T8> Qualification Matches will occur according to the official Match schedule. This schedule will indicate *Alliance* partners, *Qualification Match* times, and, if the event has multiple *Fields*, which *Field* each *Qualification Match* will be played on.

- a. *Practice Matches* may be included in the *Match Schedule* at some events, but are not required. If *Practice Matches* are run, every effort must be made to equalize practice time for all *Teams*.
- b. A *Qualification Match* can only start before its scheduled time if all *Teams*, *Robots*, and assigned volunteers are at the *Field* and ready to play.
- c. Any multi-division event must be approved by VEX Robotics prior to the event, and divisions must be assigned in sequential order by *Team* number.
- d. The official *Match Schedule* is subject to changes at the *Event Partner's* discretion. Events should generally wait to generate the *Match Schedule* until all *Teams* have checked in and passed *Robot* inspection, or when it has been confirmed that *Teams* will not be participating.

- e. If a *Team* must be removed from the *Finals Match* schedule after *Finals Alliances* have been formed (see <T12b>), the *Event Partner* can use the full-event *Disqualification* feature in TM to remove that *Team* from their scheduled *Finals Match*. Their spot in the *Finals Alliance* will be filled manually by the *Event Partner* by the next-highest-ranked *Team* that is not already in a *Finals Alliance*. If that *Team* is unavailable or unwilling to participate, the *Event Partner* can manually select the next-highest-ranked and available *Team*. If no replacement *Team* is available, the remaining half of that *Alliance* will play alone.

<T9> Each Team will be scheduled Qualification Matches as follows.

- a. A *Tournament* must include a minimum of six *Qualification Matches* per *Team* at local qualifying events or eight *Qualification Matches* per *Team* at a Championship event.
- b. A league must include at least three league ranking sessions, with at least one week between sessions. Each session must include a minimum of two *Qualification Matches* per *Team* at that session. The suggested number of *Qualification Matches* per *Team* for a standard league ranking session is four. *Event Partners* may also choose to have *Qualification Matches* as part of their league finals session.

<T10> Teams are ranked by their average Qualification Match scores.

- a. When in a *Tournament*, every *Team* will be ranked based on the same number of *Qualification Matches*.
- b. For *Tournaments* that have more than one division, *Teams* will be ranked among all *Teams* in their specific division.
- c. When in a league, every *Team* will be ranked based on the number of *Matches* played. *Teams* that participate in less than 60% of the total *Matches* available will be ranked below *Teams* that participate in at least 60% of the total *Matches* available (e.g., if the league offers 3 ranking sessions with 4 *Qualification Matches* per *Team*, *Teams* that participate in 8 or more *Matches* will be ranked higher than *Teams* who participate in 7 or fewer *Matches*). Being a no-show to a *Match* that a *Team* is scheduled in still constitutes participation for these calculations.
- d. A certain number of a *Team's* lowest *Qualification Match* scores will be excluded from the rankings based on the quantity of *Qualification Matches* each *Team* plays. Excluded scores do not affect participation for leagues. "No show" *Matches*, as described in <GG2>, are not considered lowest scores for the purposes of calculating a *Team's* *Qualification Match* ranking and will never be excluded from the calculation.
- e. In some cases, a *Team* will be asked to play an additional *Qualification Match*. The extra *Match* will be identified on the *Match Schedule* with an asterisk and will not impact the *Team's* ranking (or participation for leagues). *Teams* are reminded that <G1> is always in effect and *Teams* are expected to behave as if the additional *Qualification Match* counted.

| Number of Qualification Matches per Team | Number of excluded Match scores |
|--|---------------------------------|
| 4-7 | 1 |
| 8-11 | 2 |
| 12-15 | 3 |
| 16+ | 4 |

<T11> Qualification Match tiebreakers. In the case of tied scores, *Team* rankings are determined throughout *Qualification Matches* by:

- a. Removing the *Team*'s lowest score and comparing the new average score.
- b. Removing the *Team*'s next lowest score and comparing the new average score (on through all scores).
- c. If the *Teams* are still tied, the *Teams* will be sorted by random electronic draw.

<T12> How Alliances are formed for Teamwork Matches. During each *Teamwork Match*, two (2) *Teams* form an *Alliance* that will play on the *Field*.

- a. *Qualification Match Alliances* are randomly assigned by the tournament software.
- b. *Finals Match Alliances* are assigned as follows based on *Teams*' rankings after all *Qualification Matches* have concluded (see <T10>):
 - i. The first- and second-ranked *Teams* form an *Alliance*.
 - ii. The third- and fourth-ranked *Teams* form an *Alliance*.
 - iii. And so on, until all *Teams* participating in *Finals Matches* (see <T13>) have formed an *Alliance*.
- c. If a *Team* must be removed from the *Finals Match* schedule after *Finals Alliances* have been formed (see <T12b>), the *Event Partner* can use the full-event *Disqualification* feature in TM to remove that *Team* from their scheduled *Finals Match*. Their spot in the *Finals Alliance* will be filled manually by the *Event Partner* by the next-highest-ranked *Team* that is not already in a *Finals Alliance*. If that *Team* is unavailable or unwilling to participate, the *Event Partner* can manually select the next-highest-ranked and available *Team*. If no replacement *Team* is available, the remaining half of that *Alliance* will play alone.

<T13> Teams playing in Finals Matches. The number of *Finals Matches*, and therefore the number of *Teams* who will participate in *Finals Matches*, is determined by the *Event Partner*. Events that qualify *Teams* directly to the VEX Robotics World Championship must have a minimum of five *Finals Matches* per division if there are ten or more *Teams* in attendance.

<T14> Finals Match Schedule. *Finals Matches* are played sequentially, starting with the lowest-ranked *Alliance*. Each *Alliance* will participate in one *Finals Match*. The *Alliance* with the highest *Finals Match* score is the *Teamwork Champions*.

- a. *Alliances* are ranked by their *Finals Match* score. The highest-scoring *Alliance* is in first place, the second-highest-scoring *Alliance* is in second place, etc.
- b. Ties for first place will result in a series of tiebreaker *Finals Matches*, starting with the lower-seeded *Alliance*. The *Alliance* with the highest tiebreaker *Finals Match* score will be declared the *Teamwork Champions*.
 - i. If the tiebreaker *Finals Match* scores are tied, the *Alliance* with the higher *Match Stop Time* will be declared the winner.
 - ii. If the *Match Stop Time* is also tied, a second series of tiebreaker *Finals Matches* will be played. If this second series of tiebreaker *Finals Match* is also tied, then the higher-seeded *Alliance* will be declared the winner.

- c. If there is a tie for a place other than first, the higher-seeded *Alliance* will receive the higher rank.
- d. For *Tournaments* that have more than one division, each division will have its own set of *Finals Matches*. The winners of each division will then have an overall event Finals.

Example 1: *Alliance 6* and *Alliance 3* are tied for first place. During the tiebreaker *Finals Match*, *Alliance 6* scores 13 points and has a *Match Stop Time* of 12 seconds. *Alliance 3* scores 13 points and has a *Match Stop Time* of 10 seconds. *Alliance 6* is the Teamwork Challenge winner.

Example 2: *Alliance 4* and *Alliance 5* are tied for third place. *Alliance 4* is the third place winner and *Alliance 5* is the fourth place winner. In this way, the lower ranked *Alliance* must "overcome" the higher ranked *Alliance* in order to become the Teamwork Challenge champion.

<T15> Skills Match Schedule. Teams play *Robot Skills Matches* on a first-come, first-served basis. Each *Team* will get the opportunity to play exactly three *Driving Skills Matches* and three *Autonomous Coding Skills Matches* at each *Tournament* and/or *League Session*.

Teams should review the event agenda and their *Match Schedule* to determine when the best possible time is to complete their *Robot Skills Matches*. If the *Robot Skills Match* area closes before a *Team* has completed all six *Robot Skills Matches*, but it is determined that there was adequate time given, then the *Team* will automatically forfeit those unused *Matches*.

- a. *Robot Skills Matches* are only available to *Teams* who participate in *Qualification Matches*, unless the event is an approved Skills-Only Event. *Teams* who participate in *Qualification Matches* during a specific *League Ranking Session* are the only *Teams* who can participate in *Robot Skills Matches* at that session.
- b. Skills scores recorded by ineligible *Teams* will be deleted from *Tournament Manager* before the event is finalized on events.vex.com.

<T16> There is no requirement that Robot Skills Match fields have the same consistent modifications as the Teamwork fields. For example, there is no requirement that *Robot Skills Match Fields* are elevated to the same height as *Teamwork Match Fields*.

In order to use non-conforming *Teamwork Match Fields* for *Robot Skills Matches* (e.g. during lunch), the following steps should be taken:

- *Teams* must be informed that the *Teamwork Match Fields* may have some differences from the *Robot Skills Match Fields* (e.g., they might be elevated).
- *Teams* must be given an opportunity to select which type of *Field* they want to use, i.e. they cannot be required to use a *Teamwork Field* for any *Robot Skills Match*.

<T17> Skills Rankings at events. *Teams* will be ranked at an event based on the following scores and tiebreakers:

1. Sum of highest *Autonomous Coding Skills Match* score and highest *Driving Skills Match* Score.
2. Highest *Autonomous Coding Skills Match* score.

3. Second-highest *Autonomous Coding Skills Match* score.
4. Second-highest *Driving Skills Match* score.
5. Highest sum of *Skills Stop Times* from a *Team's* highest *Autonomous Coding Skills Match* and highest *Driving Skills Match* (i.e., the *Matches* in point 1).
6. Highest *Skills Stop Time* from a *Team's* highest *Autonomous Coding Skills Match* (i.e., the *Match* in point 2).
7. Third-highest *Autonomous Coding Skills Match* score.
8. Third-highest *Driving Skills Match* score.
9. If the tie cannot be broken after all above criteria (i.e., both *Teams* have the exact same scores and *Skills Stop Times* for each *Autonomous Coding Skills Match* and *Driving Skills Match*), then the following ordered criteria will be used to determine which *Team* had the "best" *Autonomous Coding Skills Match*:
 - i. Points for *Bean Bags* on the *L4 Goal*.
 - ii. Points for *Bean Bags* in the *L3 Goal*.
 - iii. Points for *Bean Bags* in the *L2 Goal*.
10. If the tie still cannot be broken, the same process in the step above will be applied to the *Teams' highest Driving Skills Matches*.
11. If the tie still isn't broken, the *Event Partner* may choose to allow *Teams* to have one more deciding *Match*, or both *Teams* may be declared the winner.

<T18> Skills Rankings globally. *Teams* are ranked based on their Robot Skills scores from *Tournaments* and *Leagues* that upload results to events.vex.com, according to the following tiebreakers.

1. Highest Robot Skills score (combined *Autonomous Coding Skills Match* and *Driving Skills Match Score* from a single event).
2. Highest *Autonomous Coding Skills Match* score (from any event).
3. Highest sum of *Skills Stop Times* from the *Robot Skills Matches* used for point 1.
4. Highest *Skills Stop Time* from the *Autonomous Coding Skills Match* used for point 2.
5. Highest *Driving Skills Match* score (from any event).
6. Highest *Skills Stop Time* from the *Driving Skills Match* score used in point 5.
7. Earliest posting of the highest *Autonomous Coding Skills Match* score. The first *Team* to post a score ranks ahead of other *Teams* that post the same score at a later time, all else being equal.
8. Earliest posting of the highest *Driving Skills Match* score. The first *Team* to post a score ranks ahead of other *Teams* that post the same score at a later time, all else being equal.

<T19> Robot Skills at League Events. At league events in which *Teams* may submit Robot Skills Challenge scores across multiple sessions, the Robot Skills scores (combined highest *Autonomous Coding Skills Match* and *Driving Skills Match* scores) used for rankings will be calculated from *Matches* within the same session.

For example, consider the following scores for a hypothetical *Team* across two league event sessions:

| | Autonomous Coding Skills Match | Driving Skills Match | Robot Skills Score |
|-----------|---------------------------------------|-----------------------------|---------------------------|
| Session 1 | 25 | 45 | 70 |
| Session 2 | 30 | 42 | 72 |

This *Team* would have a Robot Skills score of 72 for this event's rankings, and their scores from Session 2 would be used for the event and global tiebreakers listed in <T17> and <T18>.





vEX IQ
ROBOTICS
COMPETITION
LEVEL UP

2026 - 2027
Appendix A - Field Overview

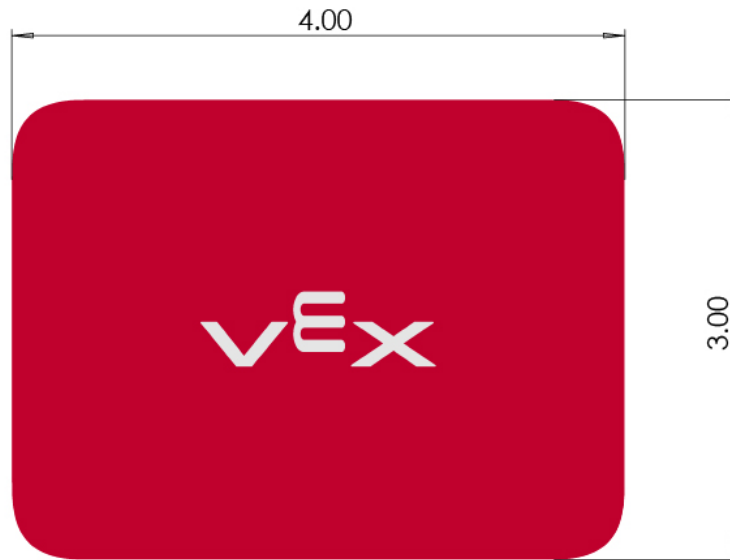

Appendix A - Field Overview



| | | | |
|---|-------------|-----------------------------|--|
|  | Description | | Bean Bag |
| | Dwg No | | Appendix A |
| | Competition | VEX IQ Robotics Competition | |
| | Release | 4/7/2026 | ALL DIMENSIONS ARE IN INCHES(mm) |
| | | | WWW.VEXROBOTICS.COM |

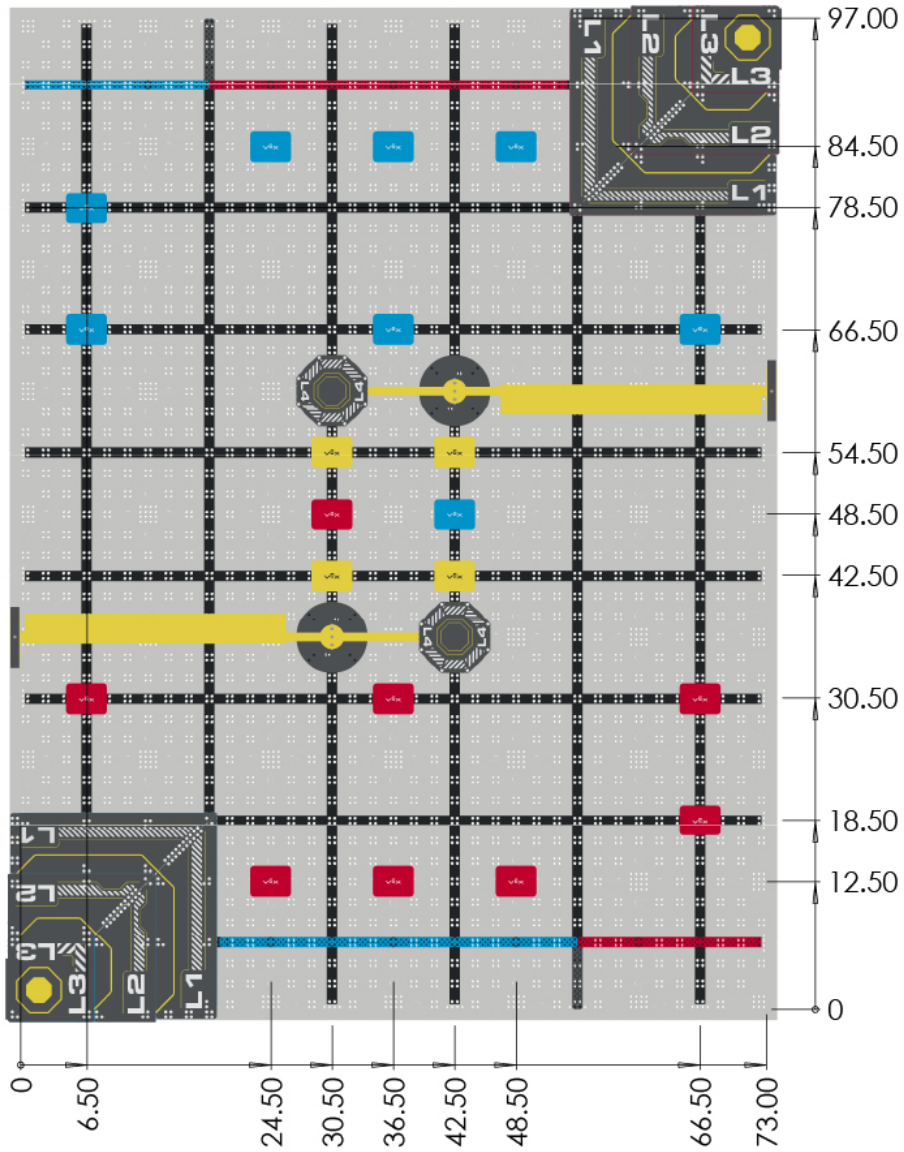

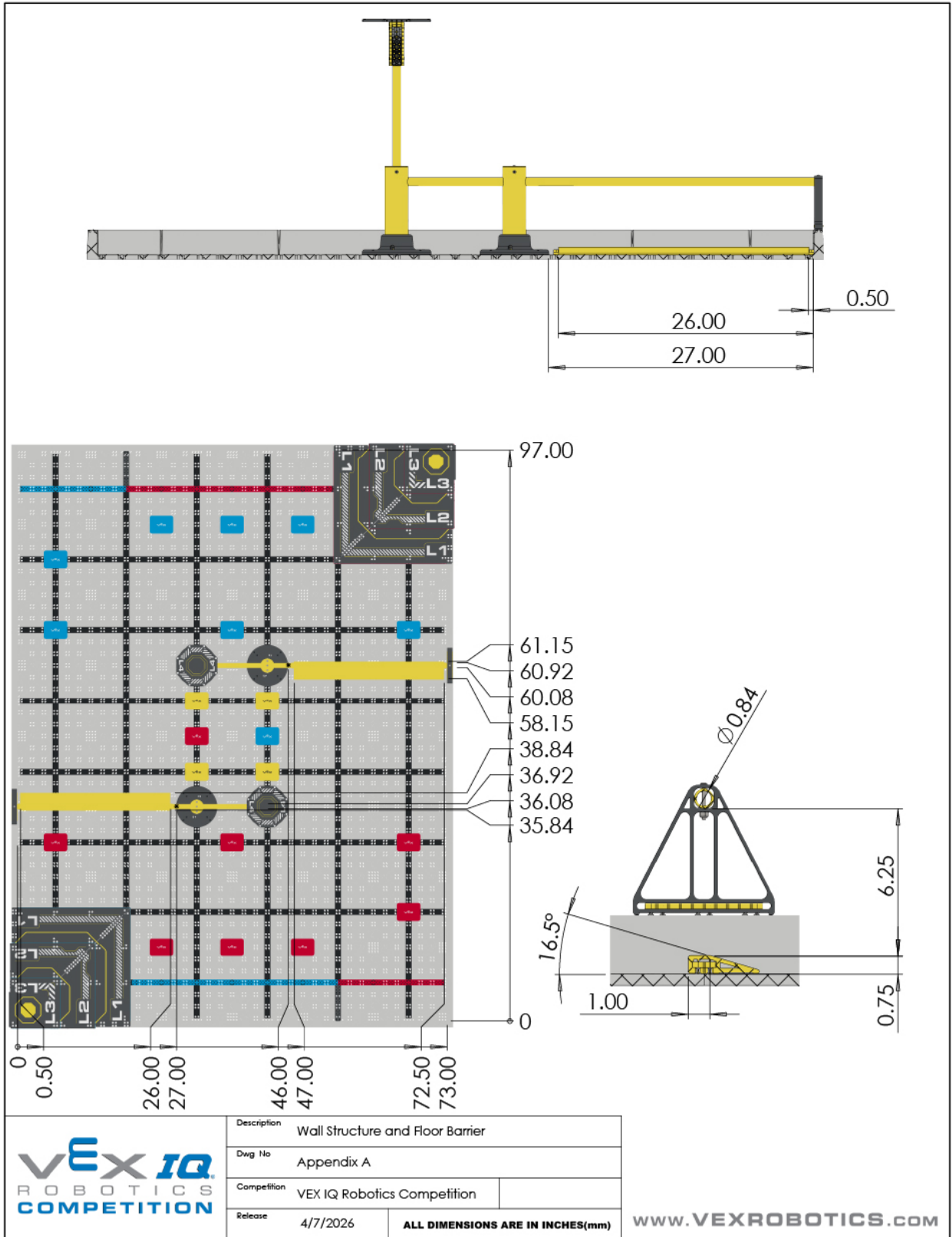

| | | | |
|--|-------------|----------|----------------------------------|
| | Description | | Bean Bag Locations |
| | Dwg No | | Appendix A |
| | Competition | | VEX IQ Robotics Competition |
| | Release | 4/7/2026 | ALL DIMENSIONS ARE IN INCHES(mm) |
| | | | WWW.VEXROBOTICS.COM |

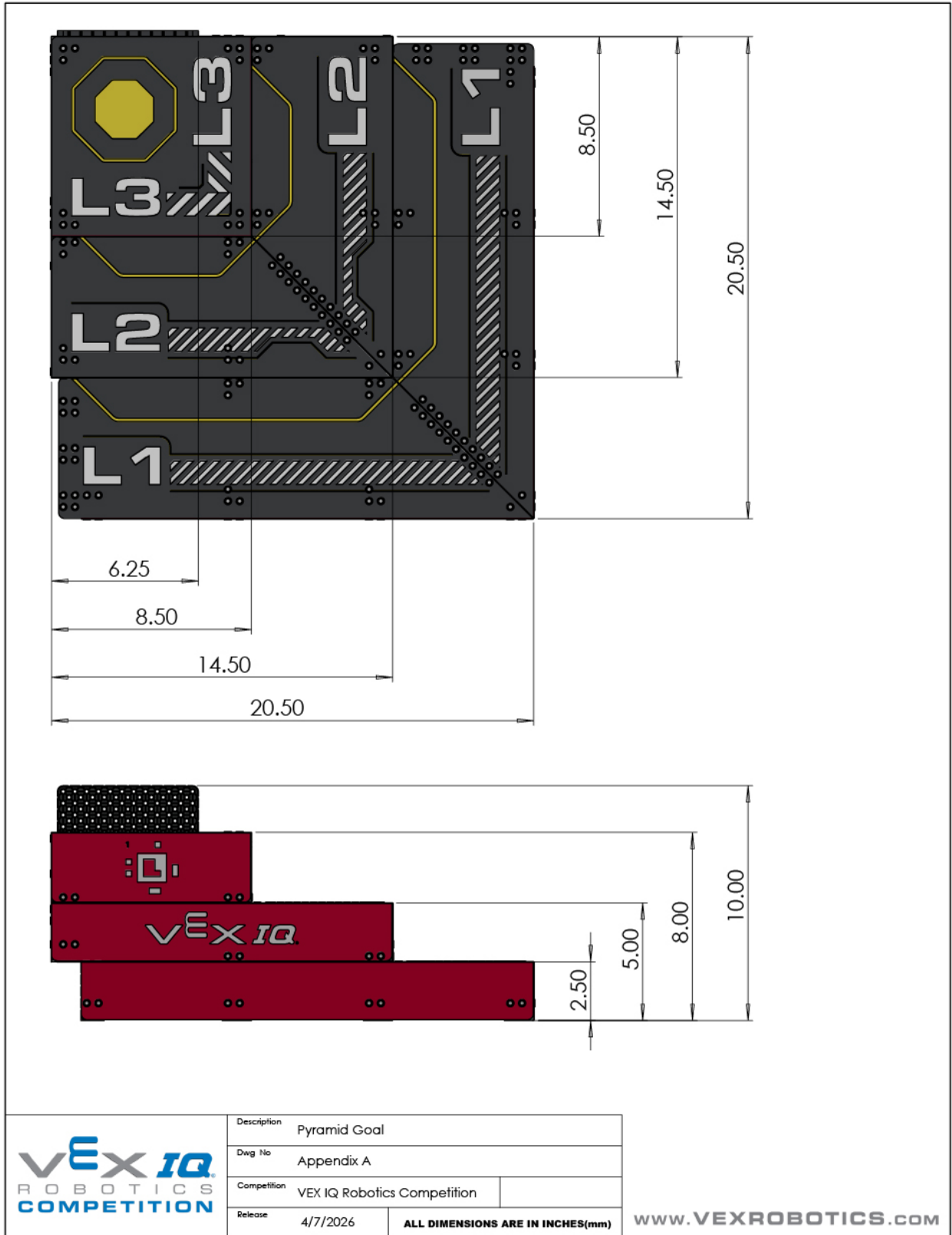

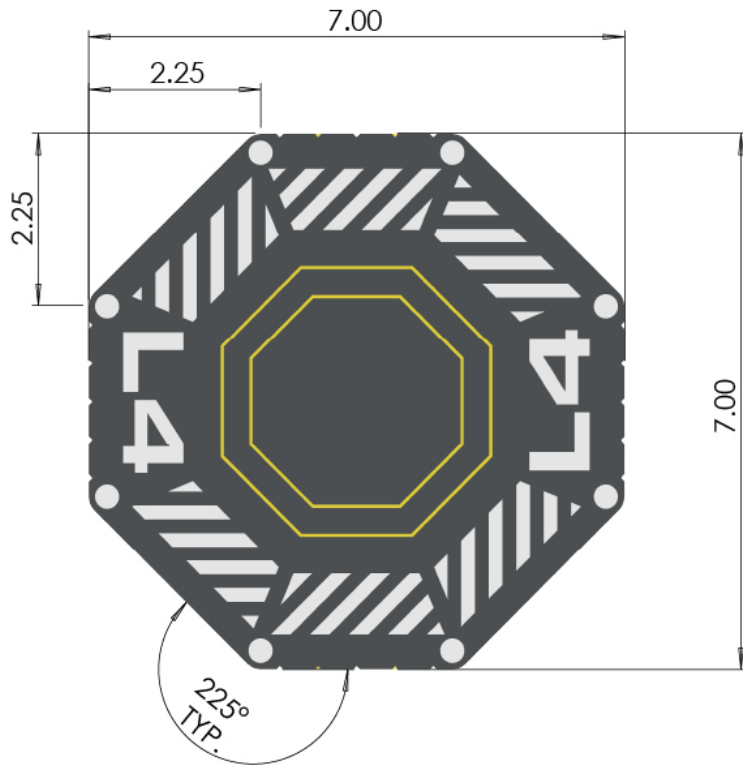
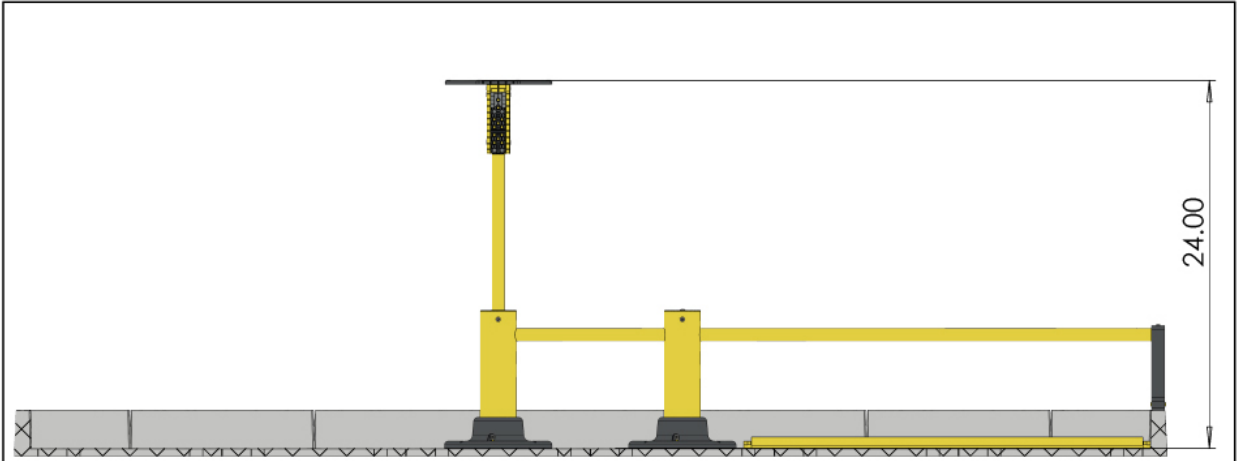

| | | | |
|--|-------------|-----------------------------|--|
| | Description | Pyramid Goal | |
| | Dwg No | Appendix A | |
| | Competition | VEX IQ Robotics Competition | |
| | Release | 4/7/2026 | ALL DIMENSIONS ARE IN INCHES(mm) |
| | | | WWW.VEXROBOTICS.COM |



| | | | |
|---|---------------------|----------------------------------|--|
|  | Description L4 Goal | | www.VEXROBOTICS.COM |
| | Dwg No Appendix A | | |
| | Competition | VEX IQ Robotics Competition | |
| | Release | 4/7/2026 | |
| | | ALL DIMENSIONS ARE IN INCHES(mm) | |

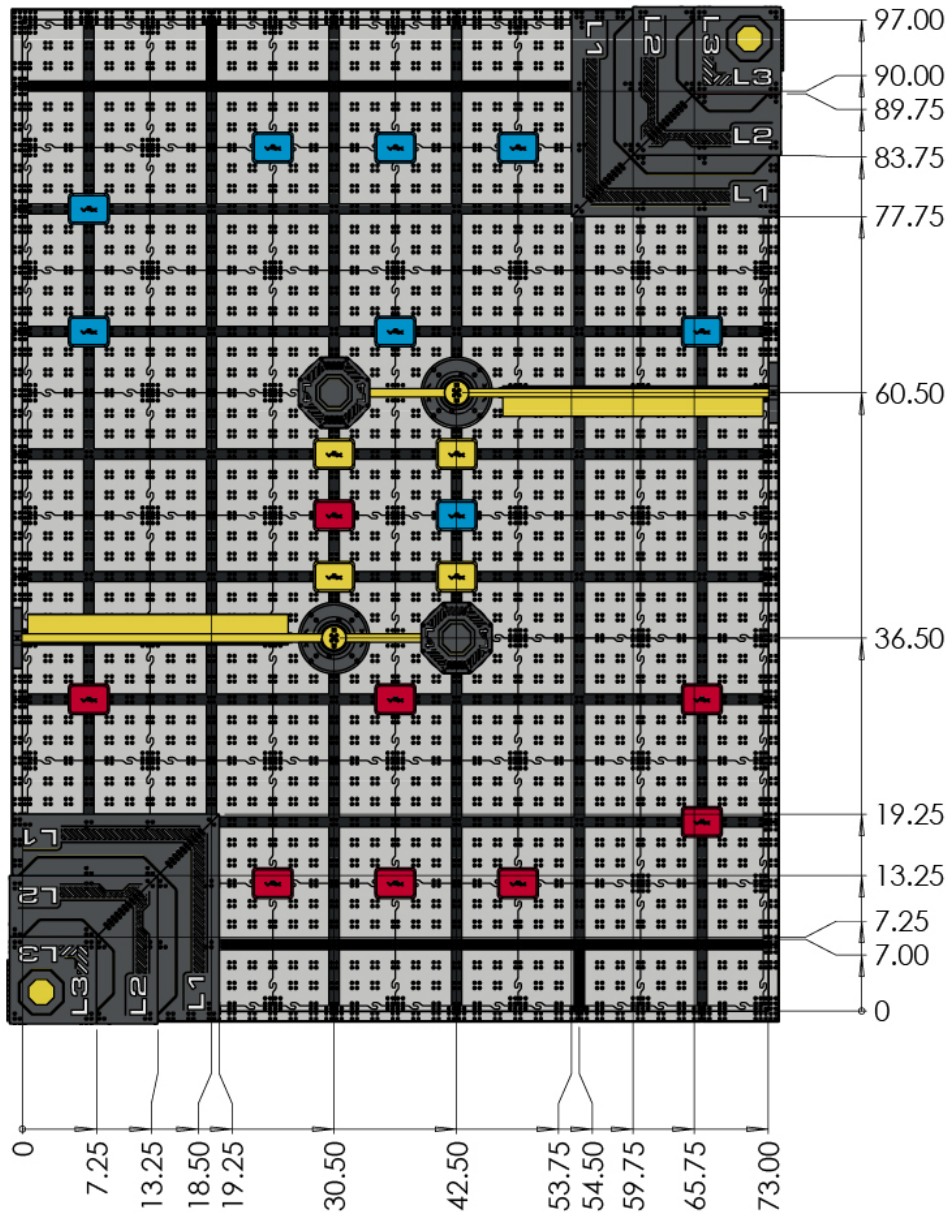

| | | |
|--|-------------|--|
| | Description | Goal Locations |
| | Dwg No | Appendix A |
| | Competition | VEX IQ Robotics Competition |
| | Release | 4/7/2026 |
| | | ALL DIMENSIONS ARE IN INCHES(mm) |
| | | WWW.VEXROBOTICS.COM |



vEX IQ
ROBOTICS
COMPETITION
LEVEL UP

2026 - 2027
Appendix B - Simplified Edition

Appendix B - Simplified Edition

Using this Appendix

Hey, *Students!*

Welcome to the VEX IQ Robotics Competition. We're excited to see you play Level Up! We know that learning new things can be hard, and that the game manual can feel like a lot. That's why we're here to help.

You and your teammates can start here and work together to learn about the *Field*, how to earn points, the basic rules, and different ways to play the game.

This section does not include all of the rules. You will still need to learn them all! After you understand everything here, and before your first event, go to the official game manual to make sure you know all the rules.

We hope you have fun, make new friends, and work together to build your best *Robot*. Have an awesome season!

Hi, *Adults!*

This unofficial version of the VEX IQ Robotics Competition manual is a print-friendly resource for you and your *Teams* to help introduce *Students* to this season's game, Level Up.

It's very important to note that this is NOT a replacement for reading the official manual in its entirety. We encourage you to use this Appendix to support *Team* members who may be overwhelmed by the full game manual, and use it to aid in building a basic understanding of the game. Once *Students* are comfortable with this appendix and the rules outlined here, you should transition them to reading and using the full game manual, where they will gain a full-depth comprehension of the VEX IQ Robotics Competition.

We hope that you'll find this guide helpful and that more *Students* feel welcomed, supported, and empowered to join your *Teams*.

Your Robotics friends,
The VEX Robotics Competition Game Design Committee

Important Rules

It is important to follow all of the rules in Level Up. This applies to both *Students* and *Adults*. The choices that *Students* and *Adults* make work together, so everyone should follow the rules.

Treat everyone with respect. <G1>

- Be kind and do your best. This is one of the most important parts of VEX IQ.
- Be respectful. It's okay for *Students* and *Adults* to disagree, but it's never okay to be disrespectful.
- Be a good sport. Think about how your actions affect others.
- Include everyone. *Alliances* should always work together to make a plan. You cannot tell another *Team* how they must play.

VIQRC is a Student-centered program. <G2>

- The *Student-Centered Policy* is very important because VEX IQ is a competition for *Students*.
- This means that the *Students* come up with the ideas, build the *Robots*, write the code, fix problems, and compete.
- *Adults* can teach, but cannot do the work on the *Robots*, code, engineering notebook, or strategies. They can give tips, but not answers.
- *Students* should speak up in a respectful way if an *Adult* is doing too much. Give a reminder that *Student Centered* is a rule all the time and everywhere with VEX IQ Robotics Competitions.

How do you play Level Up?

Level Up is a game where two *Robots* work together to place *Bean Bags* on *Goals* to score points. During a *Match*, both *Robots* earn points. These points are added together to get a *Teamwork Challenge* score. *Teams* are ranked based on their scores in *Teamwork Matches*. The top *Teams* compete in *Finals Matches* to find a *Teamwork Champion*.

Teams can also play in *Robot Skills Matches* to see how well their *Robot* works on its own. There are two types: *Driving Skills Matches* (you control the *Robot*) and *Autonomous Coding Skills Matches* (the *Robot* runs using code written by *Students*).

Game Pieces and Goals

Bean Bags

- There are 38 *Bean Bags* in each *Match*. *Bean Bags* can be red, blue, or yellow.
- Some *Bean Bags* start on the *Field*, some are put into the *Field* by *Loaders*, and each *Robot* can start with a *Preload* <SG5>.



The three types of Bean Bags.

Goals

- There are three (3) types of Goals: *Floor Goal*, *Pyramid Goal* and *L4 Goal*.

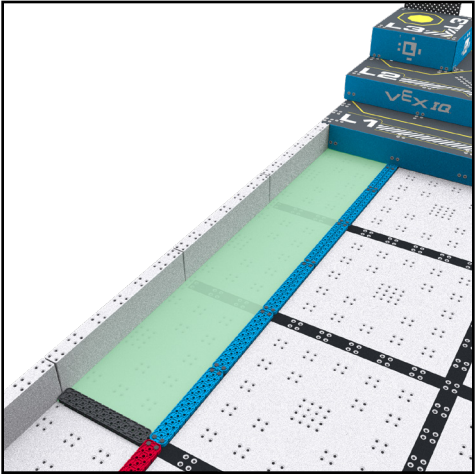

A Floor Goal

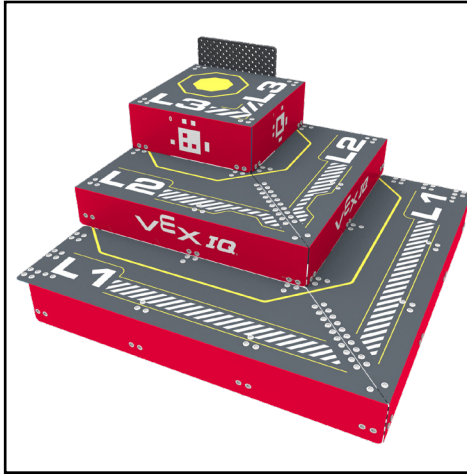

A Pyramid Goal



An L4 Goal

How to Earn Points

Robots score Bean Bags in the Floor Goal <SC3>

- *Bean Bags* must be fully inside the *Floor Goal* and not touching any VEX IQ parts on the *Floor*.
- *Bean Bags* must match the color of the *Floor Goal*, or be yellow to score points

Robots score Bean Bags on the Pyramid Goal <SC4>

- *Bean Bags* must be resting on the *Pyramid Goal* or another *Bean Bag*. They cannot touch *Robots*, or anything outside of the *Field*.
- *Bean Bags* must match the color of the *Pyramid Goal*, or be yellow to score points

Robots score Bean Bags on the L4 Goal <SC5>

- *Bean Bags* must be resting on the *L4 Goal* or another *Bean Bag*, and not touching any *Robots*
- *Bean Bags* must be yellow to score points

Robot Rules

Before the Match starts, *Robots* cannot be bigger than 11" by 20" and cannot be taller than 15". After the Match starts, *Robots* may grow bigger and taller by following rules **<SG2>** and **<SG3>**.

Your *Robot* has to be designed, built, and coded by the *Students* on your *Team*, not by *Adults* **<R2>**, using only VEX IQ parts **<R12>**.

Drive Team

Three *Students* make up the Drive Team for each *Match*:

- Driver 1 - Drives the *Robot* for the first 30 seconds **<GG11>**
- Driver 2 - Drives the *Robot* for the last 30 seconds
- Loader - Places *Bean Bags* into the *Field* during the *Match* **<SG7>**

Your *Team* can use different people in these roles each *Match*, but all must be members of your *Team*. **<G5>** and **<GG11>**

Matches and Referees

- *Drive Team Members* should know who the *Head Referee* is each *Match*. **<T1>**
- *Robots* must stop moving at the end of the *Match* **<GG12>** and can end the *Match* early. **<GG13>**
- Scores are added at the end of the *Match*. The *Head Referee* or *Scorekeeper Referee* will share them with the *Drive Team Members*. **<SC1>**
- Only *Drive Team Members* can talk to the *Head Referee* about a *Match*. They must do this right after the *Match* without *Team Adults*. **<SC2>**
- The *Head Referee* makes the final decision. *Students* may respectfully ask questions, but may not argue after the decision is made. **<T3>**



vEX IQ
ROBOTICS
COMPETITION
LEVEL UP

2026 - 2027

Appendix C - Glossary of Terms



Appendix C - Glossary of Terms

Adult - Anyone who is not a *Student* or another defined term (e.g., *Head Referee*).

Alliance - A pre-assigned grouping of two *Teams* that are paired together during a given *Teamwork Match*.

Alliance Score - Points scored in a *Teamwork Match* that are awarded to both *Teams*.

Autonomous Coding Skills Match - see *Match*.

Autonomous Period - A time period during which *Robots* operate and react only to sensor inputs and/or commands pre-programmed by the *Students* into the *Robot* control system.

Bean Bag - see *Scoring Object*.

Builder - Any *Student Team* member who helps build the *Robot*. *Adults* are permitted to teach *Builders* associated concepts, but should never work on the *Robot*.

Coder - Any *Student Team* member who contributes to the code that is downloaded onto the *Robot*. *Adults* are permitted to teach *Coders* associated concepts, but should never work on the code that goes on the *Robot*.

Designer - Any *Student Team* member who helps design the *Robot* to be built for competition. *Adults* are permitted to teach *Designers* associated concepts, but should never work on the design of the *Robot*.

Disablement - A penalty applied to a *Team* for a safety *Violation*. During a *Disablement*, a *Team* is no longer allowed to operate their *Robot*, and the *Drivers* will be asked to place their controller down. A *Disablement* is not the same as a *Disqualification*.

Disqualification - A penalty applied to a *Team* for a *Major Violation* (see <GG6> for more details). If a *Team* receives a *Disqualification* in a *Match*, the *Head Referee* will notify the *Team* of their *Violation* at the end of the *Match*. At the *Head Referee's* discretion, repeated *Violations* and/or *Disqualifications* for a single *Team* may lead to its *Disqualification* for the entire event.

Driver - A *Student Team* member who stands in the *Driver Station* and is responsible for operating and controlling that *Team's Robot* during defined segments of a *Match*. Up to two *Team* members may fulfill this role in a given *Match* (see <GG1>), and there is no requirement that the same *Students* serve as *Drivers* in multiple *Matches*.

Driver Controlled Period - A time period during which *Drivers* operate their *Robot* using a VEX IQ controller.

Driver Station - A region beside the *Field* where the *Drivers* must remain during their *Match* unless legally interacting with their *Robot*. The *Driver Stations* are represented by the red and blue lines in Figure FO-3.

Drive Team Members - The two *Drivers* and one *Loader* who participate in a given *Match* as representatives of their *Team*. No *Student* may fill more than one role on a Drive Team in the same *Match*.

- *Driver 1* - Drives the *Robot* until the mid-*Match Driver* switch (see <GG11>)
- *Driver 2* - Drives the *Robot* after the mid-*Match Driver* switch (see <GG11>)
- *Loader* - Introduces *Scoring Objects* into the *Field* for the whole *Match*

Driving Skills Match - see *Match*.

Event Partner - The volunteer VEX IQ Robotics Competition *Tournament* coordinator who serves as an overall manager for the volunteers, venue, event materials, and all other event considerations.

Field - The entire playing *Field*, being six (6) *Field* tiles wide by eight (8) *Field* tiles long (totaling forty-eight (48) *Field* tiles), including the *Field Perimeter*.

Field Element - The *Field Perimeter*, *Floor*, PVC pipes, and VEX IQ pieces which comprise and/or are attached to the *Field*.

Field Perimeter - The outer part of the *Field*, made up of four (4) outside corners and twenty-four (24) straight sections.

Finals Match - see *Match*.

Floor - The interior flat part of the playing *Field*, made up of the forty-eight (48) *Field* tiles that are within the *Field Perimeter*.

Game Design Committee (GDC) - The creators of VIQRC Level Up, and authors of this Game Manual. The *Game Design Committee* is the only official source for rules clarifications and Q&A responses; see Section 1.

Goal - A location inside the *Field* where *Scoring Objects* can be placed to earn points. There are multiple types of *Goal* in VIQRC Level Up:

- **Floor Goal** - A segment of the *Floor* on the short end of the *Field*. Each *Floor Goal* is bordered by the inside of the *Field Perimeter* and the inside edges of the VEX IQ pieces connected to the *Floor*. Each *Floor Goal* has a color, red or blue, determined by its VEX IQ pieces.
- **Pyramid Goal** - A three-tiered structure in a corner of the *Field*, which includes three *Goals* of graduating size. Each *Pyramid Goal* includes a set of horizontal grey PET sheets marked as L1, L2, or L3. Each *Pyramid Goal* has a color, red or blue, determined by the color of its vertical PET sheets.
 - **L1 Goal** - The lowest *Goal* in a *Pyramid Goal*, labeled as L1 on its horizontal PET sheet.
 - **L2 Goal** - The middle *Goal* in a *Pyramid Goal*, labeled as L2 on its horizontal PET sheet.
 - **L3 Goal** - The upper *Goal* in a *Pyramid Goal*, labeled as L3 on its horizontal PET sheet; includes a backstop aligned with the long side of the *Field*.
- **L4 Goal** - A vertical structure built from PVC pipe and VEX IQ pieces, which includes a horizontal PET sheet labeled as L4. *L4 Goals* do not have a defined color.

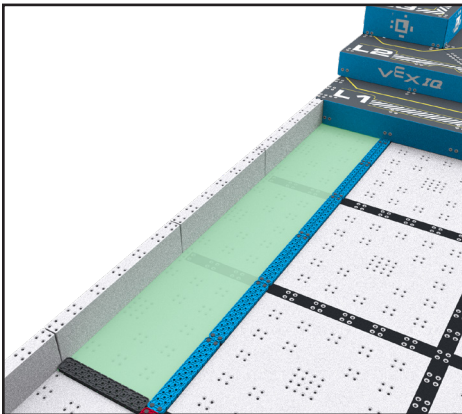

Figure G-1: The blue *Floor Goal* (highlighted in green).

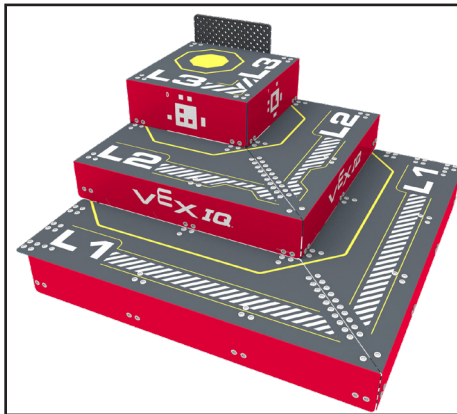

Figure G-2: The red *Pyramid Goal*, including a red L1 *Goal*, red L2 *Goal*, and red L3 *Goal*.



Figure G-3: An *L4 Goal*.

Head Referee - A certified impartial volunteer responsible for enforcing the rules in this manual as written. *Head Referees* are the only people who may discuss ruling interpretations or scoring questions with *Teams* at an event. Large events (e.g., Signature Events, World Championships, etc.) might include multiple *Head Referees* at the *Event Partner's* discretion.

License Plate - A physical component on the *Robot* that displays the *Team's* VEX IQ Robotics Competition number. Each *License Plate* must have a length and height of 3.5" x 1.5" (88.9mm x 38.1mm) and must not exceed a width of 0.25" (6.35mm) per <R4>.

Load - The act of legally introducing a *Scoring Object* into the *Field*. See <SG7>.

Load Zone - A segment of the *Floor* on a short end of the *Field*. Each *Load Zone* is bordered by the inside of the *Field Perimeter* and the inside edges of the VEX IQ pieces connected to the *Floor*. Each *Floor Goal* has a color, red or blue, determined by its VEX IQ pieces. The *Load Zone* is intended to receive *Scoring Objects* from a human *Loader*.

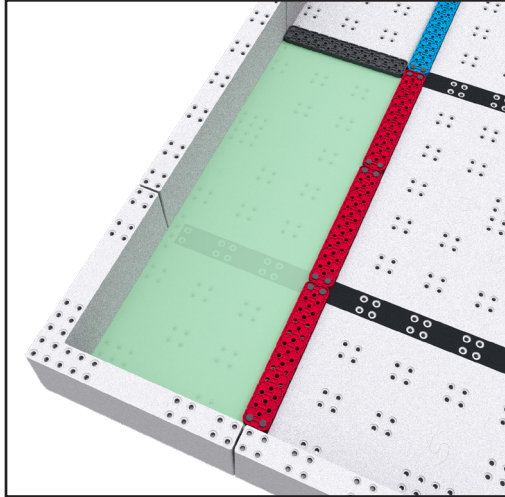

Figure LZ-1: The red Load Zone (highlighted in green).

Match - A set time period, consisting of *Autonomous Periods* and/or *Driver Controlled Periods*, during which *Teams* play a defined version of Level Up to earn points. See Sections 2 & 3.

Match types:

- *Autonomous Coding Skills Match* - A *Robot Skills Match* in which a single *Robot* operates during a one minute *Autonomous Period*. There is no *Driver Controlled Period*. *Teams* can elect to end an *Autonomous Coding Skills Match* early if they wish to record a *Skills Stop Time*.
- *Driving Skills Match* - A *Robot Skills Match* in which one *Team* operates their *Robot* during a one minute *Driver Controlled Period*. There is no *Autonomous Period*. *Teams* can elect to end a *Driving Skills Match* early as described in rule <RSC8> if they wish to record a *Skills Stop Time*.
- *Finals Match* - A *Teamwork Match* used to determine the *Teamwork Champions*. See rule <T14>.
- *Practice Match* - A non-scored *Match* used to provide time for *Teams* to get acquainted with the official playing *Field* and procedures. *Head Referees* should not record or track standard gameplay *Violations* that occur during *Practice Matches*. Egregious *Violations* may be recorded and tracked at the discretion of the *Head Referee*.
- *Qualification Match* - A *Teamwork Match* that is used to determine *Teams*' rankings for *Finals Matches*.
- *Robot Skills Match* - A *Driving Skills Match* or *Autonomous Coding Skills Match*.
- *Teamwork Match* - A *Match* that consists of a two-*Team Alliance* that works together to score points in a one-minute *Match*. *Qualification Matches*, *Finals Matches*, and optional *Practice Matches* are *Teamwork Matches*.

| Match Type | Participants | Autonomous Period (m:ss) | Driver Controlled Period (m:ss) |
|---------------------------------------|--|--------------------------|---------------------------------|
| <i>Teamwork Match</i> | One <i>Alliance</i> , on one <i>Field</i> , made up of two <i>Teams</i> , each with one <i>Robot</i> | None | 1:00 |
| <i>Driving Skills Match</i> | One <i>Team</i> , with one <i>Robot</i> | None | 1:00 |
| <i>Autonomous Coding Skills Match</i> | One <i>Team</i> , with one <i>Robot</i> | 1:00 | None |

Match Load - A *Scoring Object* that begins the *Match* in a *Driver Station* and which may be introduced by a *Loader* during the *Match*. See <SG7> for more information.

Match Schedule - A list of *Matches* that is generated at the start of an event. The *Match Schedule* includes the predetermined, randomly-paired *Alliances* that will be competing in each *Qualification Match*, and the expected start times for these *Matches*. The *Match Schedule* may be subject to change at the *Event Partner's* discretion.

Qualification Match List

2026 Texas Region 5 VIQRC Elementary State Championship



| Match | Field | Time | Team 1 | Team 2 |
|-------|------------|--------------|--------|--------|
| Q1 | Main Field | Sat 10:00 AM | 1216C | 74866B |
| Q2 | Main Field | Sat 10:06 AM | 74866C | 46389A |
| Q3 | Main Field | Sat 10:12 AM | 74866A | 1040A |
| Q4 | Main Field | Sat 10:18 AM | 97401B | 75007B |
| Q5 | Main Field | Sat 10:24 AM | 68898A | 75007C |
| Q6 | Main Field | Sat 10:30 AM | 3173B | 1059B |
| Q7 | Main Field | Sat 10:36 AM | 10723B | 97401D |
| Q8 | Main Field | Sat 10:42 AM | 1216E | 1059A |
| Q9 | Main Field | Sat 10:48 AM | 1216B | 75035A |

Figure MS-1: An example of a Qualification Match Schedule.

Match Stop Time - The time remaining (i.e., displayed on the timer or audience display) in a tiebreaker *Finals Match* (which only occurs for 1st place) when an *Alliance* ends the *Match* early by placing their controllers on the ground. The *Match Stop Time* is rounded down to the nearest even number. For example, if controllers are set down when the displayed time is 13 seconds, the *Match Stop Time* is recorded as 12 seconds. If an *Alliance* does not finish the *Match* early, they receive a default *Match Stop Time* of 0 seconds.

Notebooker - Any *Student Team* member who contributes to the *Team's* engineering notebook or associated documentation. *Adults* are permitted to teach *Notebookers* associated concepts, but should never work on the engineering notebook or other documentation.

Plowing - A *Robot / Scoring Object* status. A *Robot* is considered to be *Plowing a Scoring Object* if the *Robot* is intentionally moving it in a preferred direction with a flat or convex face of the *Robot* or with another *Scoring Object*.

Possession - A *Robot / Bean Bag* status. A *Robot* is considered to be *Possessing a Bean Bag* if a change in the *Robot's* direction would result in controlled movement of the *Bean Bag*. This typically requires at least one of the following to be true:

1. The *Bean Bag* is fully supported by the *Robot*.
2. The *Robot* is moving the *Bean Bag* in a preferred direction with a concave face of the *Robot* (or inside of a concave angle formed by multiple mechanisms/faces of the *Robot*).

Practice Match - see *Match*.

Preload - A *Scoring Object* that begins the *Match* in contact with a *Robot*. See <SG5>.

Qualification Match - see *Match*.

Robot - A machine that has passed inspection, designed by *Student Team* members to execute one or more tasks autonomously and/or by remote control from *Drivers*.

Robot Skills Match - see *Match*.

Scorekeeper Referee - An impartial volunteer responsible for tallying scores at the end of a *Match*. *Scorekeeper Referees* do not make ruling interpretations, and should redirect any *Team* questions regarding rules or scores to the *Head Referee*.

Scoring Object - An object that can be placed in a *Goal* during a *Match*. There is one type of *Scoring Object* in VIQRC Level Up:

- **Bean Bag** - A blue, red, or yellow rectangular, pellet filled fabric pouch, measuring approximately 3 inches by 4 inches, and weighing approximately 40 grams.
 - *Blue Bean Bags* can be scored in the blue *Floor Goal* or the blue *Pyramid Goal*.
 - *Red Bean Bags* can be scored in the red *Floor Goal* or the red *Pyramid Goal*.
 - *Yellow Bean Bags* can be scored in any *Goal*.



Figure SO-1: Blue, red, and yellow Bean Bags

Skills Stop Time - The time remaining in a *Robot Skills Match* when a *Team* ends the *Match* early. See <RSC8> for more details.

Strategist - Any *Student Team* member who contributes to the *Match* strategies used to score points during a *Teamwork Match* or *Robot Skills Match*, including assessing the impact of other *Teams*' performance and strategies on the *Team*'s strategy (e.g., scouting). *Adults* are permitted to teach *Strategists* associated concepts, but should never create or dictate a *Team*'s *Match* strategy.

Student - Anyone born after May 1, 2011 (i.e., who will be 15 or younger at VEX Worlds 2027). Eligibility may also be granted based on a disability that has delayed education by at least one year. *Students* are the individuals who design, build, repair, and program the *Robot* with minimal *Adult* assistance.

- Elementary School Student – Any *Student* born after May 1, 2014 (i.e., who will be 12 or younger at VEX Worlds 2027). Elementary School *Students* may “play up” and compete as Middle School *Students*.
- Middle School Student - Any eligible *Student* that is not an Elementary School *Student*.

Team - Three or more *Students* make up a *Team*. In the context of this game manual, *Student Team* members fill multiple roles related to *Robot* design, build, coding, strategy, and documentation. See <G2>, <G4>, <G5> for more information. *Adults* may not fulfill any of these roles. See Appendix E for more information about *Team* classifications and *Student* roles.

Teamwork Champions - The two *Teams* in the *Alliance* with the highest *Finals Match* score. See rule <T14>.

Teamwork Match - see *Match*.

Tournament - A competition event that includes scored *Matches*, and which is run by an *Event Partner*.

Violation - The act of breaking a rule in the game manual. See Appendix D for additional information on *Violations* and penalties.

- *Minor Violation* - A *Violation* which does not result in a *Disqualification*.
- *Major Violation* - A *Violation* which results in a *Disqualification*.
- *Score Affecting* - A *Violation* which improves an *Alliance*'s score at the end of a *Match*.



vEX IQ
ROBOTICS
COMPETITION
LEVEL UP

2026 - 2027
Appendix D - Rule Violations



Appendix D - Rule Violations

This appendix is intended to provide additional guidance regarding rule *Violations* within the VEX IQ Robotics Competition, and offer further explanation on how *Violations* may be interpreted and enforced during *Matches*. It is designed to promote consistency in officiating and to help *Teams* better understand how actions on the *Field* may impact scoring, *Match* outcomes, and referee decisions.

All *Violation* notes to denote special circumstances or provide additional clarifications have been consolidated into this section such that they may be easily referenced. If no *Violation* notes are found in a given rule, then it should be assumed that the below “default” definitions apply.

This appendix does not supersede any existing rule, but instead serves as a secondary resource to aid in their application.

Violation - The act of breaking a rule in the Game Manual.

- Minor Violation - A *Violation* which does not result in a *Disqualification*.
 - Accidental, momentary, or otherwise non-*Score Affecting Violations* are usually *Minor Violations*.
 - *Minor Violations* usually result in a verbal notification from the *Head Referee* during the *Match*, which should serve to inform the *Team* that a rule is being *Violated* before it escalates to a *Major Violation*.
- Major Violation - A *Violation* which results in a *Disqualification*.
 - Unless otherwise noted in a rule, all *Score Affecting Violations* are *Major Violations*.
 - If noted in the rule, egregious or strategic *Violations* or intentional actions that result in *Violations* may also be *Major Violations*.
 - Multiple *Minor Violations* within a *Match* or *Tournament* may escalate to a *Major Violation* at the *Head Referee's* discretion or as specified in a rule. *Minor Violations* carry over into *Finals Matches* unless otherwise specified within a rule.
- Score Affecting - A *Violation* which improves an *Alliance's* score at the end of a *Match*.
 - Multiple *Violations* within a *Match* can cumulatively become *Score Affecting*.
 - When evaluating whether a *Violation* was *Score Affecting*, *Head Referees* will focus primarily on any *Robot* actions that were directly related to the *Violation*.
 - Determining whether a *Violation* was *Score Affecting* can only be done once the *Match* is complete and the scores have been calculated.
 - To determine whether a *Violation* may have been *Score Affecting*, check whether the *Violation* directly contributed to increasing the score of the *Match*. If it did not increase the *Alliance's* score, then the *Violation* was not *Score Affecting*, and it was very likely a *Minor Violation*.

Violations of <GG>, <SG>, and <RSC> rules that occur during a *Robot Skills Match* should only affect the outcome of that *Match* and should not be considered when determining whether a *Violation* has been repeated during the event.

Violation Notes by Rule

Specific Game Rules

<SG1>

1. The *Match* will not begin with any conditions in this rule unmet. If a *Robot* cannot meet these conditions in a timely manner, the *Robot* will be removed from the *Field* and rules <R2d> and <GG3> will apply until the situation is corrected. In most cases, they will not receive a *Disqualification*, but should receive a *Minor Violation* and will not be permitted to play in the *Match*.

<SG7>

1. *Teams* are responsible for their own actions. *Violations* that involve a *Loader* and *Robot* from opposite *Teams* will be given to both *Teams*.
2. It is expected that most *Violations* of this rule will be accidental. In accidental cases that end up being *Score Affecting* (e.g., an illegally-Loaded *Scoring Object* is scored in a *Goal*), the first occurrence during a *Qualification Match* may be treated as a *Minor Violation* and a "final notice" that any future *Violation* will result in *Disqualification* for the *Match*.
3. Any *Score Affecting Violation* during a *Finals Match* (accidental and intentional) must be treated as a *Major Violation*.
4. Repeated, intentional, or egregious *Violations* may escalate to a *Major Violation* at the *Head Referee's* discretion. One example of an egregious *Violation* would be placing a *Scoring Object* directly onto a *Robot* without ever contacting the *Load Zone*.

General Rules

<G1>

1. Any *Violation* of <G1> may be considered a *Major Violation* and should be addressed on a case-by-case basis. *Teams* at risk of a <G1> *Major Violation* due to multiple disrespectful or uncivil behaviors will usually receive a "final warning", although the *Head Referee* is not required to provide one).

<G2>

1. Potential *Violations* of this rule will be reviewed on a case-by-case basis. By definition, all *Violations* of this rule become *Score Affecting* as soon as a *Robot* which was built or programmed by an *Adult* scores points in a *Match*.

<G4>

1. *Teams* believed to be in *Violation* of this rule should be reported to the *Judge Advisor*, *Head Referee*, or *Event Partner* for further investigation in coordination with VEX Robotics. Based on the investigation the *Team* may be removed from further *Matches*, have their *Robot Skills Match* scores removed, and/or be removed from consideration from judged awards.
2. *Violations* of this rule will be evaluated on a case-by-case basis, as noted in <G1> and <G2>.

General Game Rules

<GG1>

1. *Major Violations* of this rule are not required to be *Score Affecting*, and could invoke *Violations* of other rules, such as <G1>, <G2>, or <G4>.

<GG9>

1. In most cases, accidental *Field* damage should only be considered a *Minor Violation*.
2. Egregious, intentional, or repeated accidental/*Minor Violations* may escalate to a *Major Violation* at the *Head Referee's* discretion.

<GG10>

1. This rule is intended to allow *Teams* to fix damaged *Robots* or help get their *Robots* "out of trouble." Strategically exploiting this rule may be considered a *Minor Violation* or *Major Violation* at the *Head Referee's* discretion.

<GG11>

1. At a minimum, any *Violation* of this rule is considered a *Minor Violation*. Whether it escalates to a *Major Violation* or not is dependent upon the *Head Referee's* judgment regarding prior *Violations* and any *Score Affecting* actions that were a direct result of the *Violation*, such as the first *Driver* scoring additional points after 35 seconds of driving or a *Driver* also serving as a *Loader* in the same *Match*.

<GG12>

1. Because scoring that happens after the *Match* is not counted, all *Violations* of <GG12> should be recorded as *Minor Violations*.
2. If a *Team* receives three *Minor Violations* within the same event, all future <GG12> *Violations* at that event will be considered *Major Violations* and *Disqualifications*.
3. This count does not reset for any reason within an event (e.g., *Teamwork Matches* vs *Finals Matches*, one of the *Team's* "dropped score" *Matches*, etc.), but does not include *Violations* that occur in *Robot Skills Matches* or *Practice Matches*.

Robot Rules

<R4>

1. A *Team* that circumvents a *Robot* rule for a competitive advantage should receive an immediate *Disqualification* for the current *Match*.



vEX IQ
ROBOTICS
COMPETITION
LEVEL UP

2026 - 2027

Appendix E - Team Classifications and Student Roles



Appendix E - Team Classifications and Student Roles

Three or more *Students* make up a *Team*. To participate in an official VEX IQ Robotics Competition event, a *Team* must first register on events.vex.com and receive a VEX IQ Robotics Competition *Team* number. A *Team's* unique number identifies their organization and their *Team* within that organization. Each *Team* must design and build their own *Robot*, create their own code, develop their own strategies to play the game, and maintain their own engineering notebook if they choose to use one.

- A *Team* is classified as an Elementary School *Team* if all members are Elementary School *Students*.
- A *Team* is classified as a Middle School *Team* if any member is a Middle School *Student*, or if the *Team* is made up of Elementary School *Students* who declare themselves as “playing up” as Middle School *Students* by registering their *Team* as a Middle School *Team*.
- Once a *Team* has competed in an event as a Middle School *Team*, that *Team* may not change to an Elementary School *Team* for the remainder of the season. If a *Team* mistakenly registers as an Elementary School *Team* but is ineligible for that age group, their registration may be revised mid-season with the assistance of VEX Robotics; all prior qualifications for the season will be lost.
- *Teams* may be associated with schools, community/youth organizations, or a group of neighborhood *Students*.

In the context of this Game Manual, *Student Team* members fill multiple roles related to *Robot* design, build, coding, strategy, and documentation. See <G2>, <G4>, <G5> for more information. *Adults* may not fulfill any of these roles.

- **Designer** - Any *Student Team* member who helps design the *Robot* to be built for competition. *Adults* are permitted to teach *Designers* associated concepts, but should never work on the design of the *Robot*.
- **Builder** - Any *Student Team* member who helps build the *Robot*. *Adults* are permitted to teach *Builders* associated concepts, but should never work on the *Robot*.
- **Coder** - Any *Student Team* member who contributes to the computer code that is downloaded onto the *Robot*. *Adults* are permitted to teach *Coders* associated concepts, but should never work on the code that goes on the *Robot*.
- **Strategist** - Any *Student Team* member who contributes to the *Match* strategies used to score points during a *Teamwork Match* or *Robot Skills Match*, including assessing the impact of other *Teams's* performance and strategies on the *Team's* strategy (e.g., scouting). *Adults* are permitted to teach *Strategists* associated concepts, but should never create or dictate a *Team's Match* strategy.
- **Notebooker** - Any *Student Team* member who contributes to the *Team's* engineering notebook or associated documentation. *Adults* are permitted to teach *Notebookers* associated concepts, but should never work on the engineering notebook or other documentation.