

Control Systems

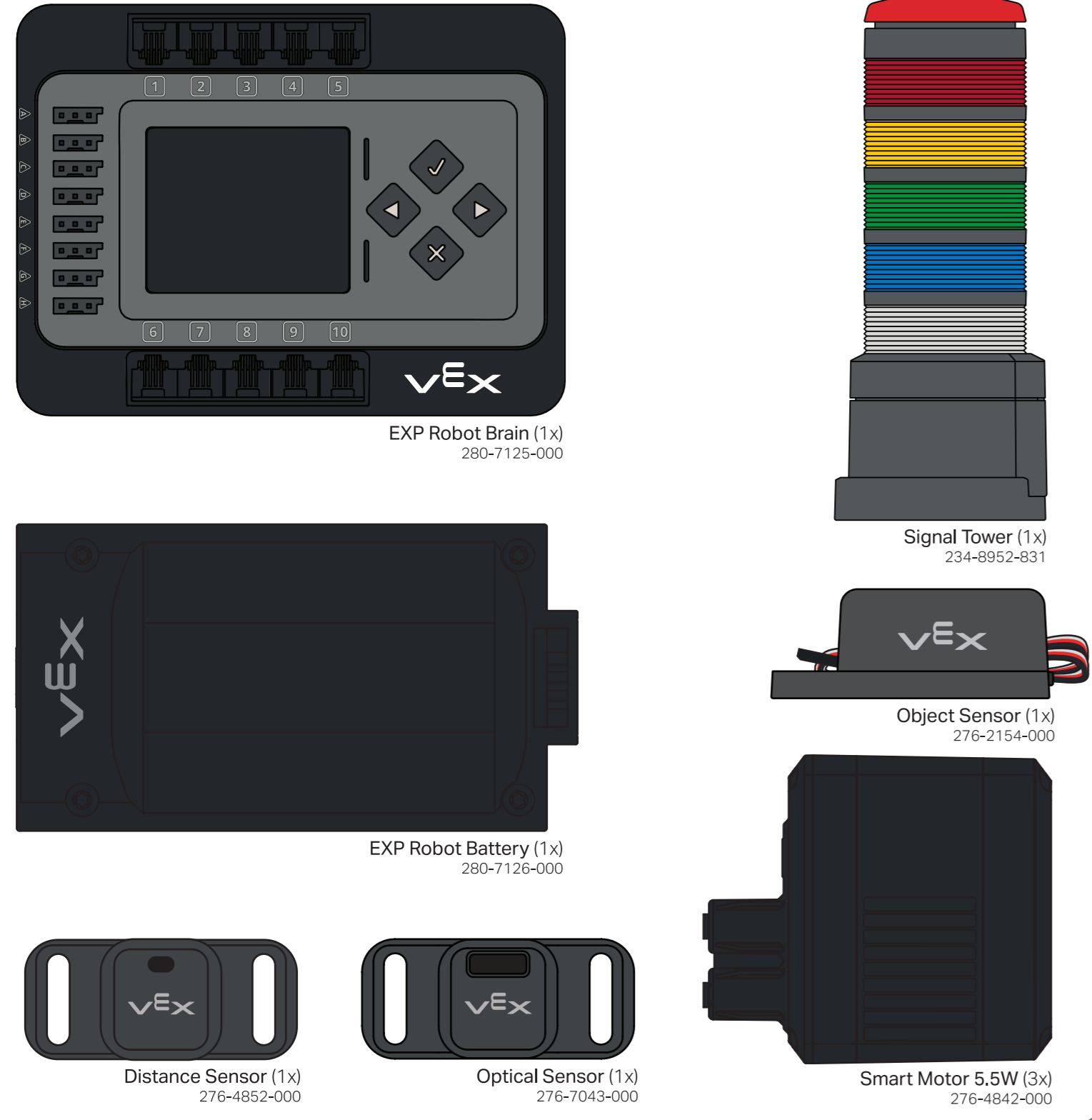

Pneumatics

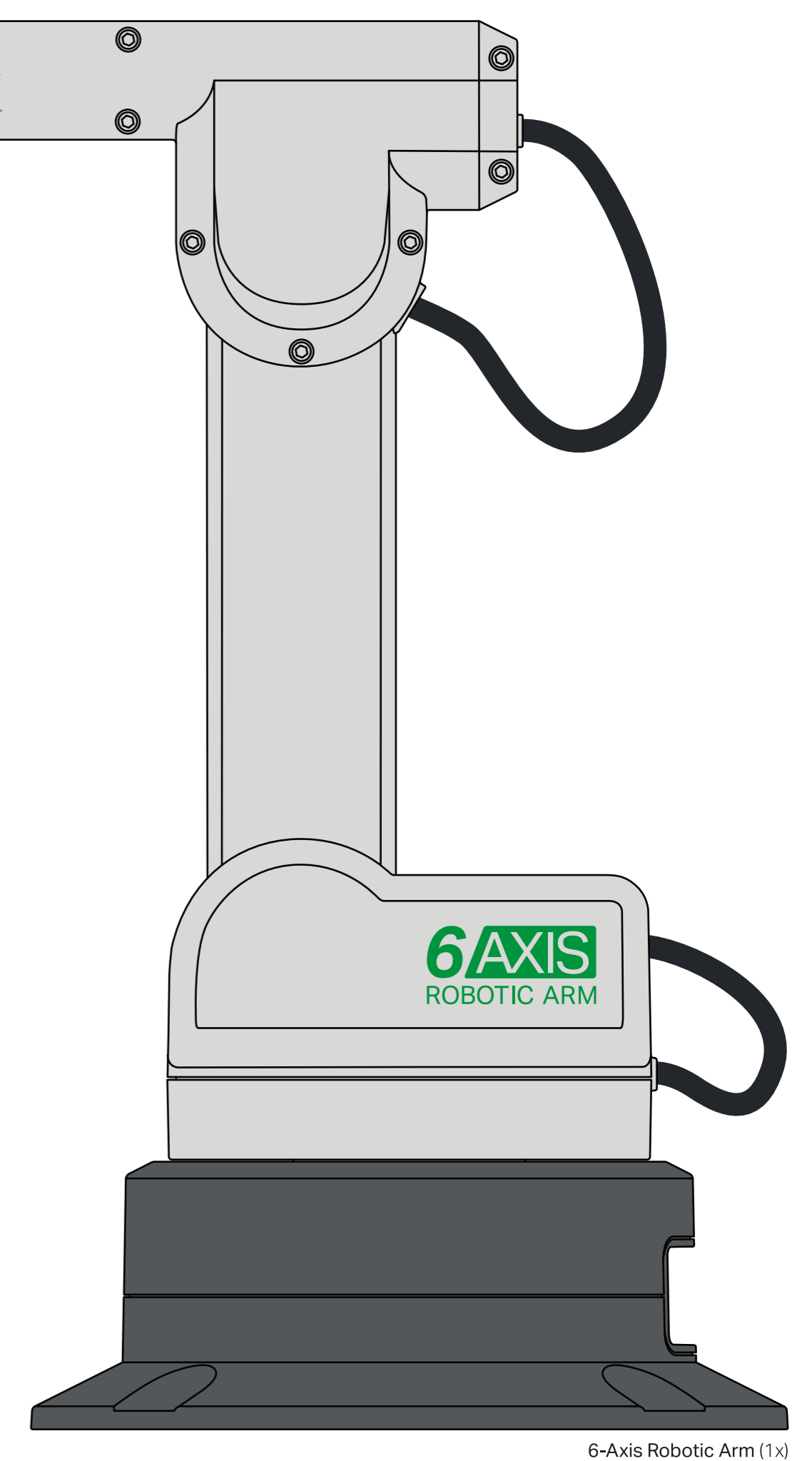
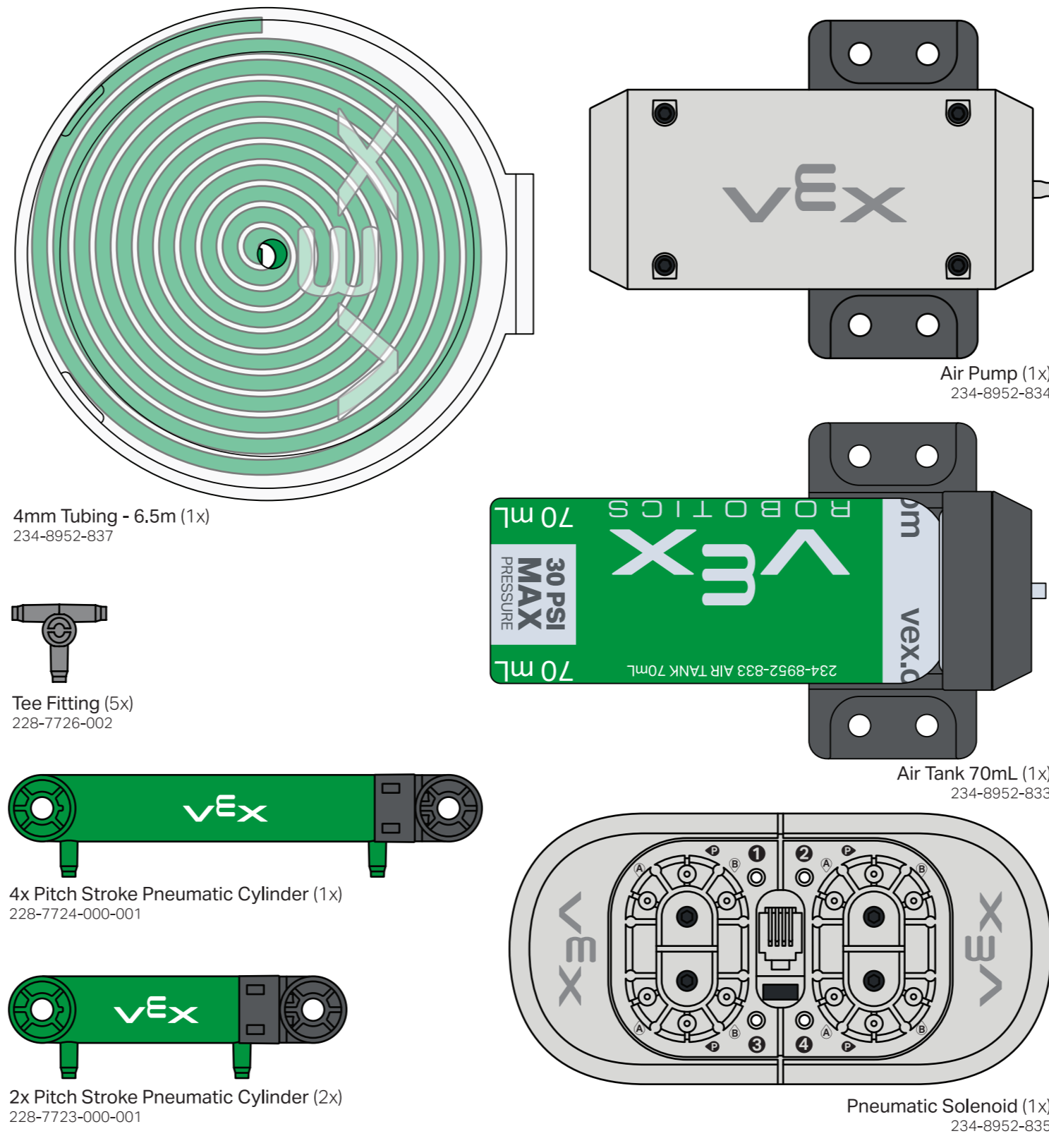

Material Transport & Handling

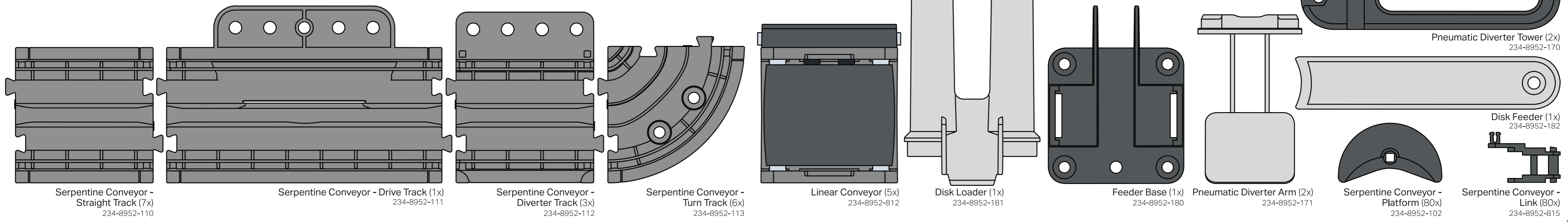

Platforms

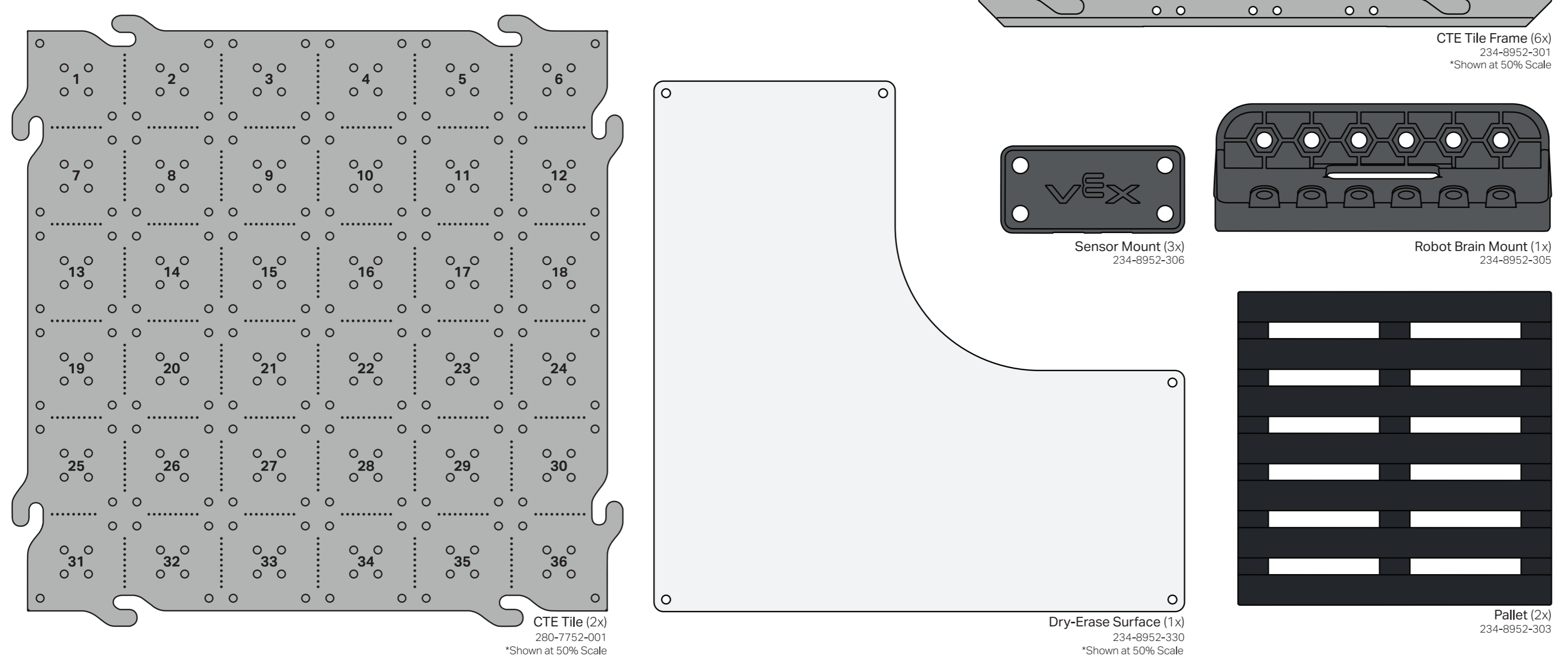

Hardware & Tools

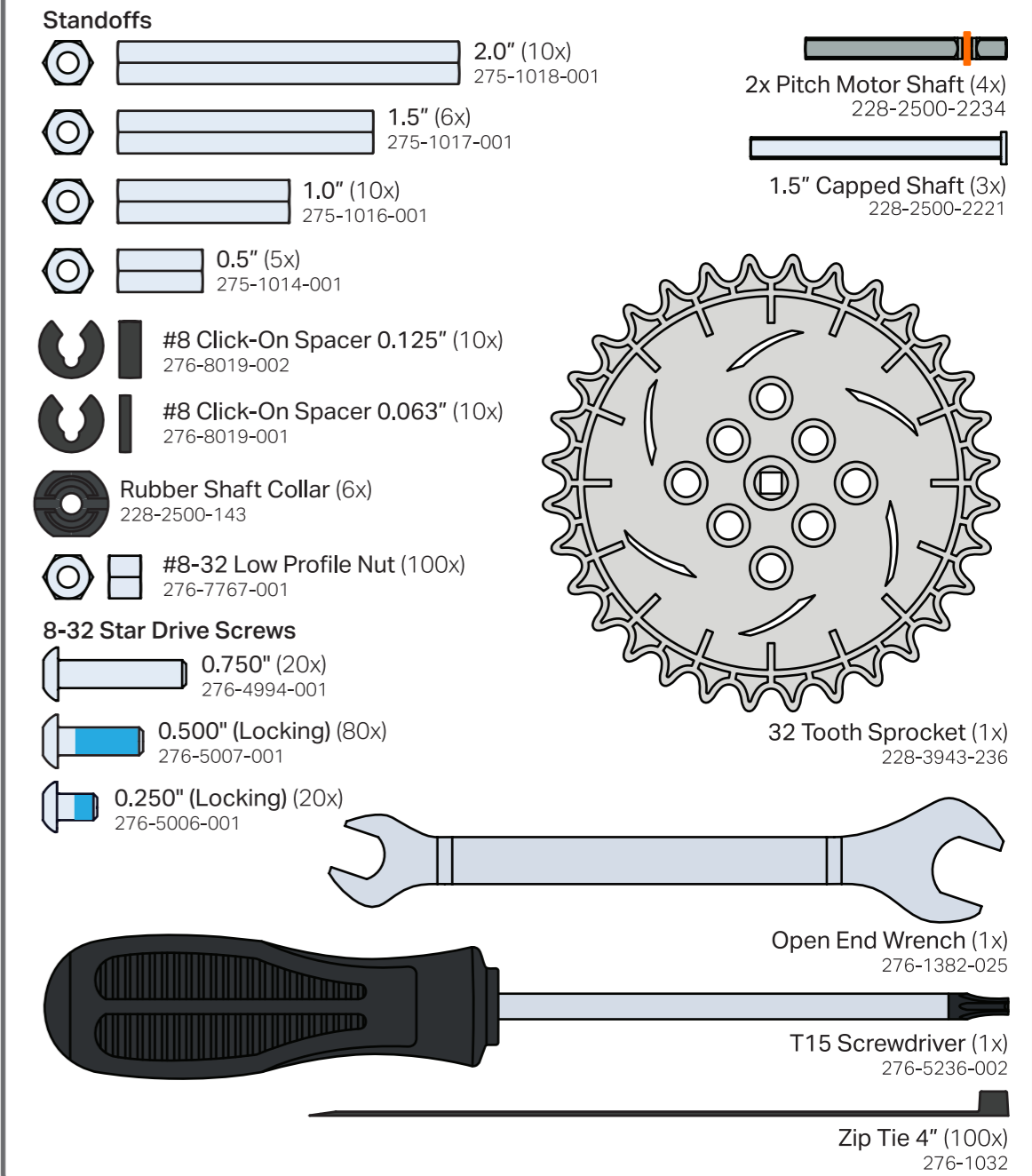

Material

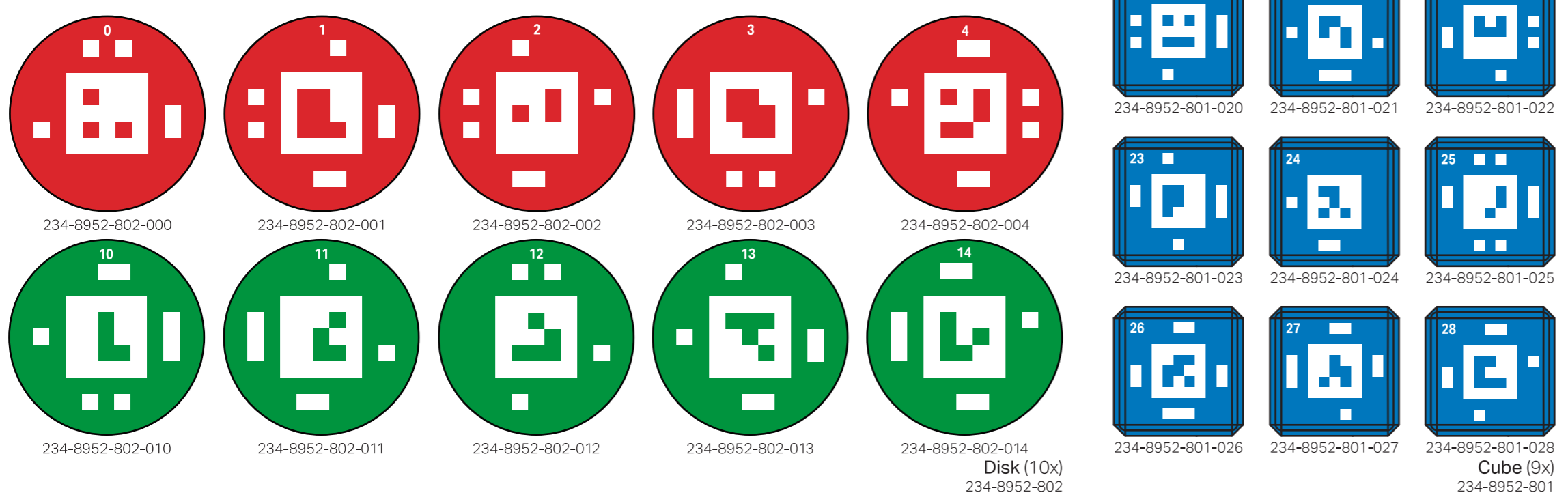

Wiring & Cables

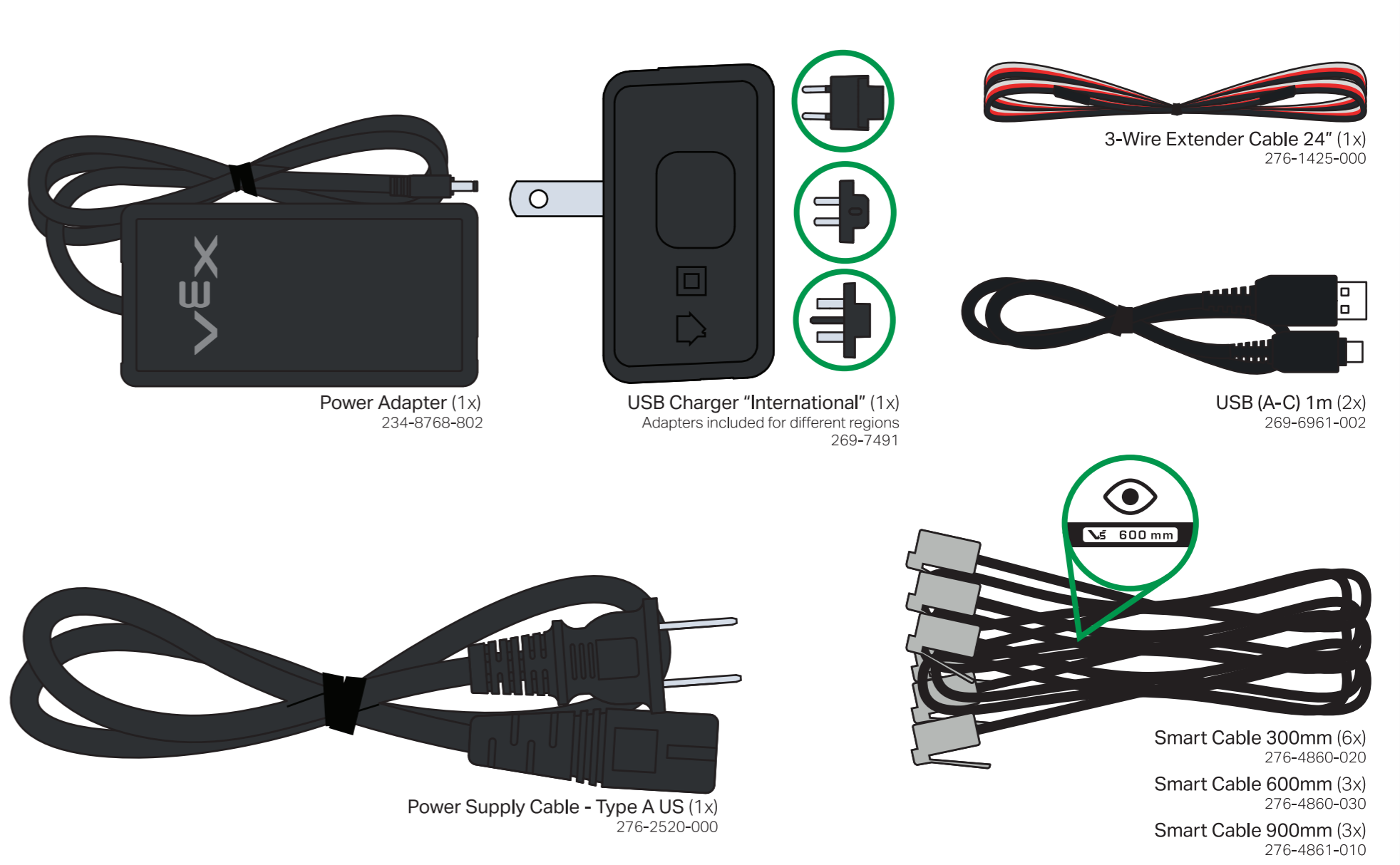

Tooling

