

# VEX GO

## Crawler Build Instructions

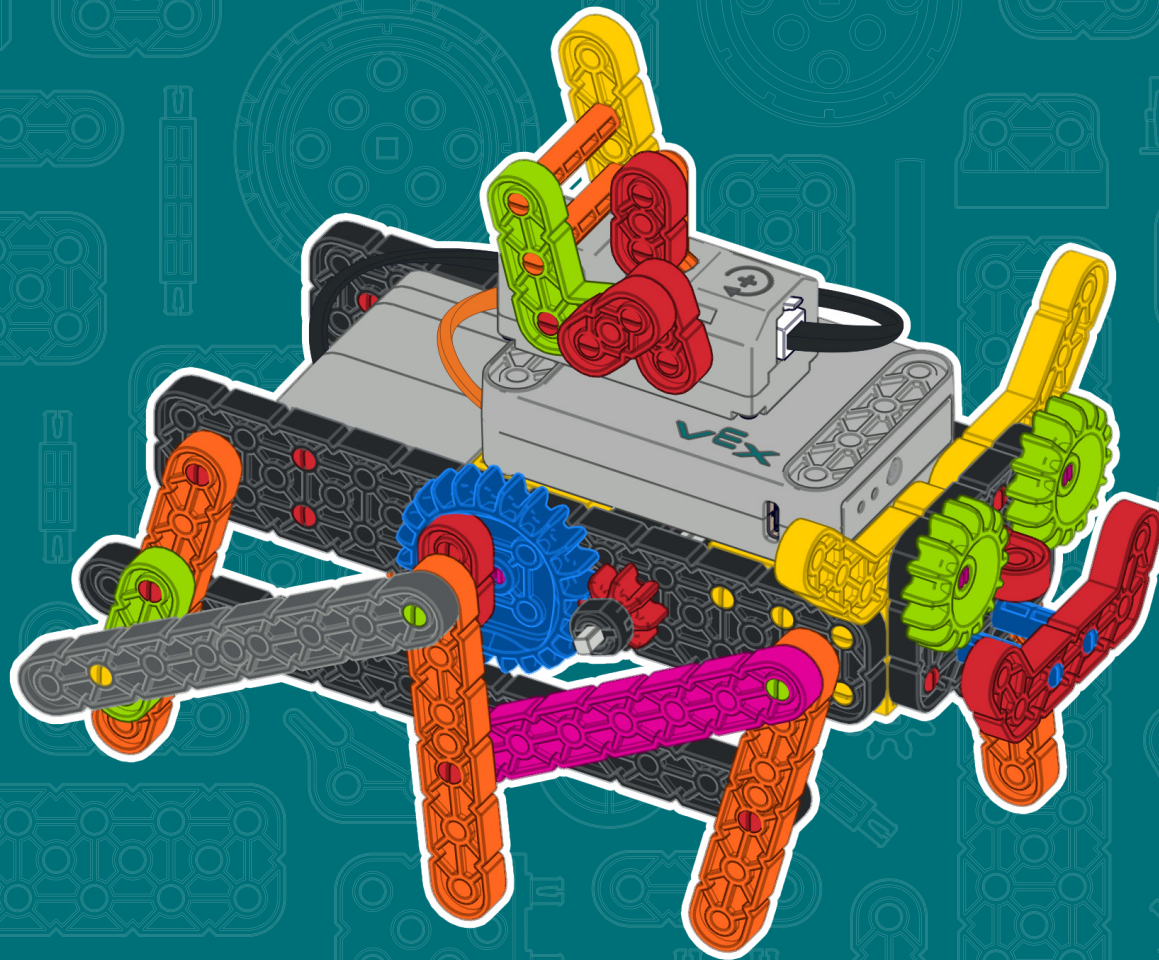

### Pins

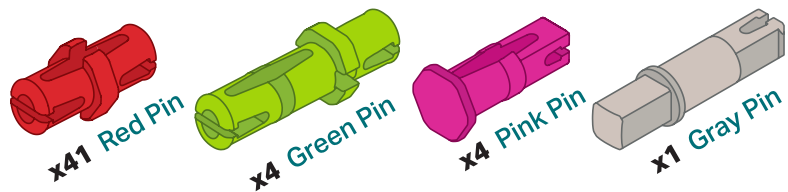

### Standoffs

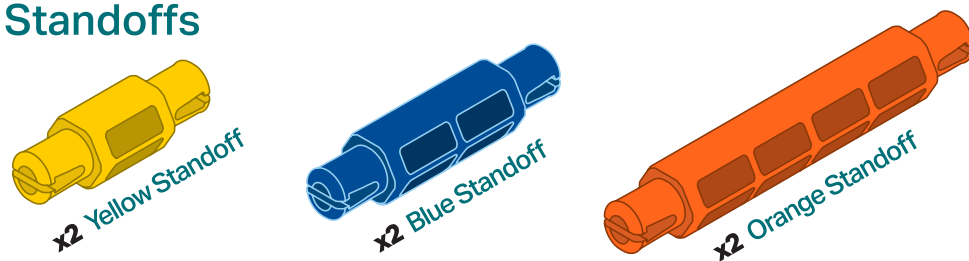

### Shafts

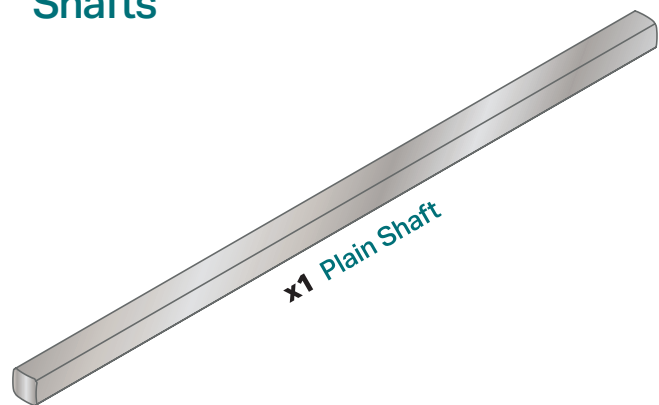

### Plates

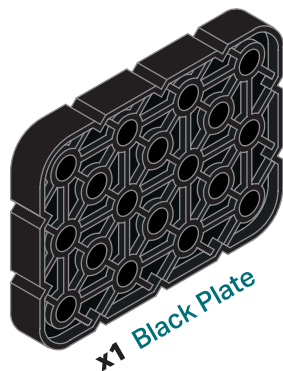

### Angle Beams

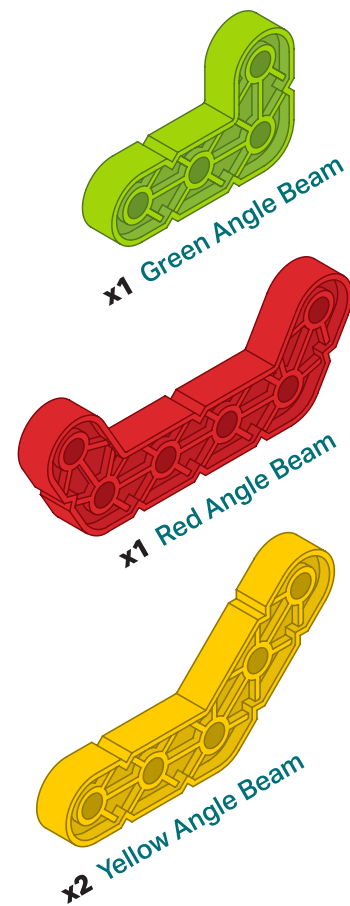

### Connectors

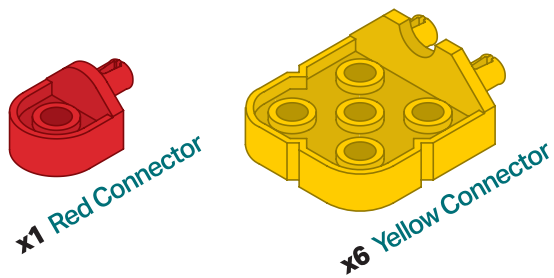

### Gears

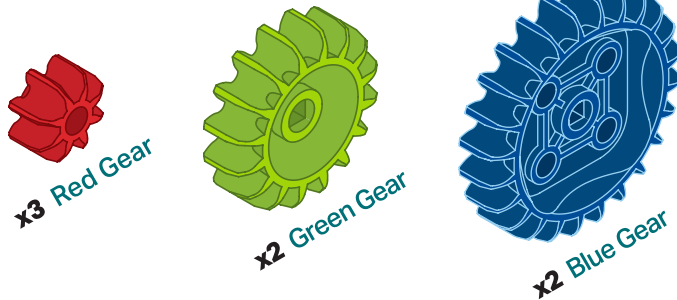

## Beams

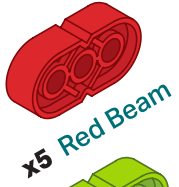

x5 Red Beam

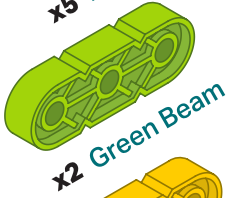

x2 Green Beam

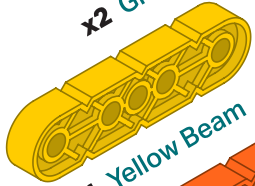

x1 Yellow Beam

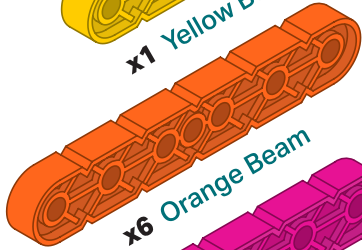

x6 Orange Beam

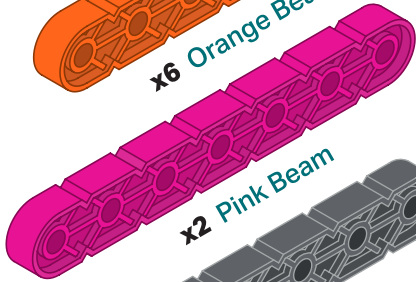

x2 Pink Beam

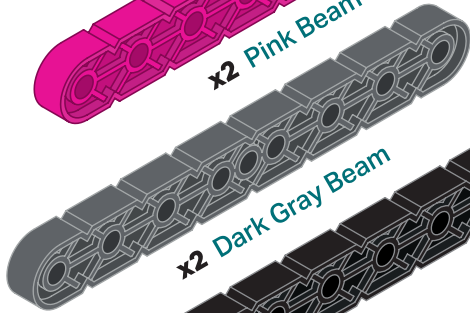

x2 Dark Gray Beam



x2 Black Beam

## Large Beams

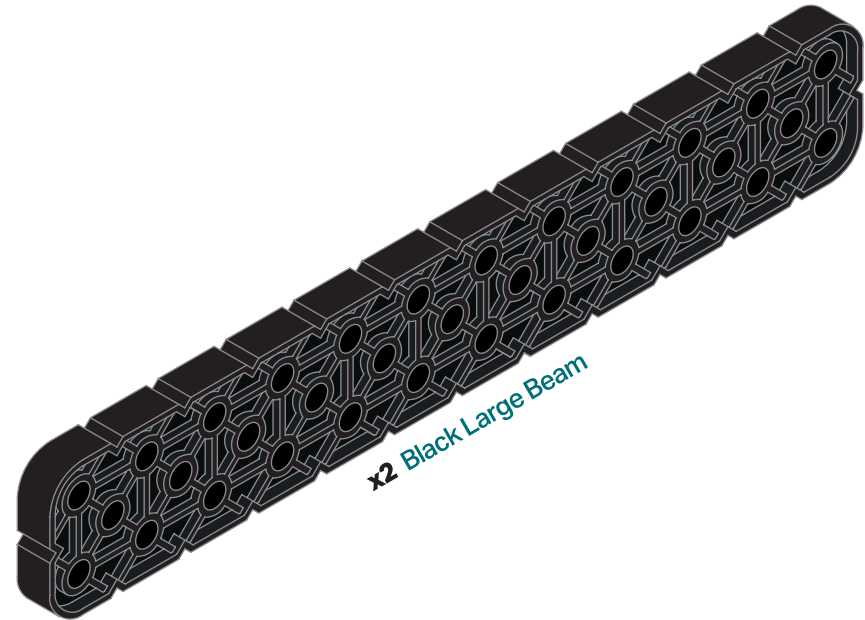

x2 Black Large Beam

## Electronics

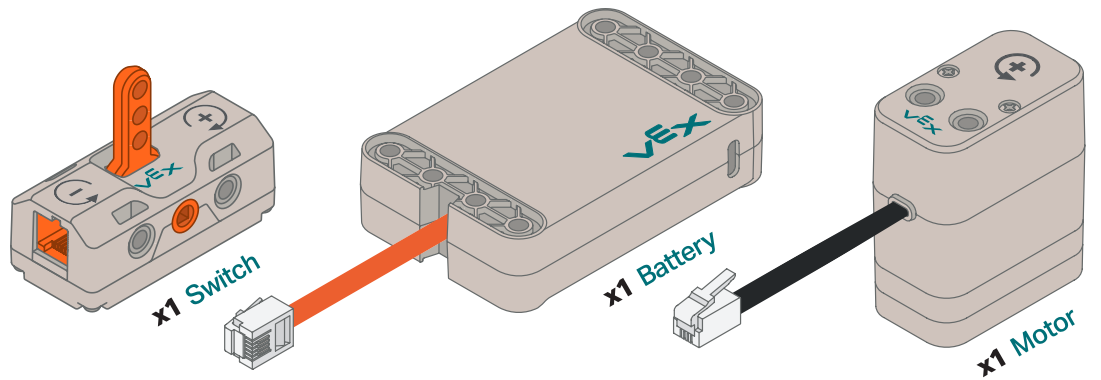

x1 Switch

x1 Battery

x1 Motor

1

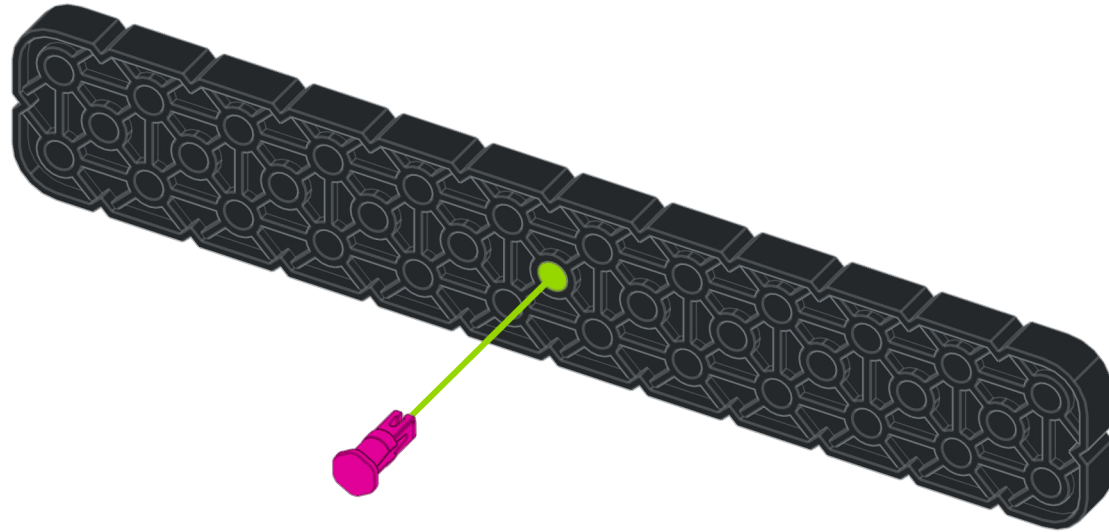

x1 Pink Pin

x1 Black Large Beam

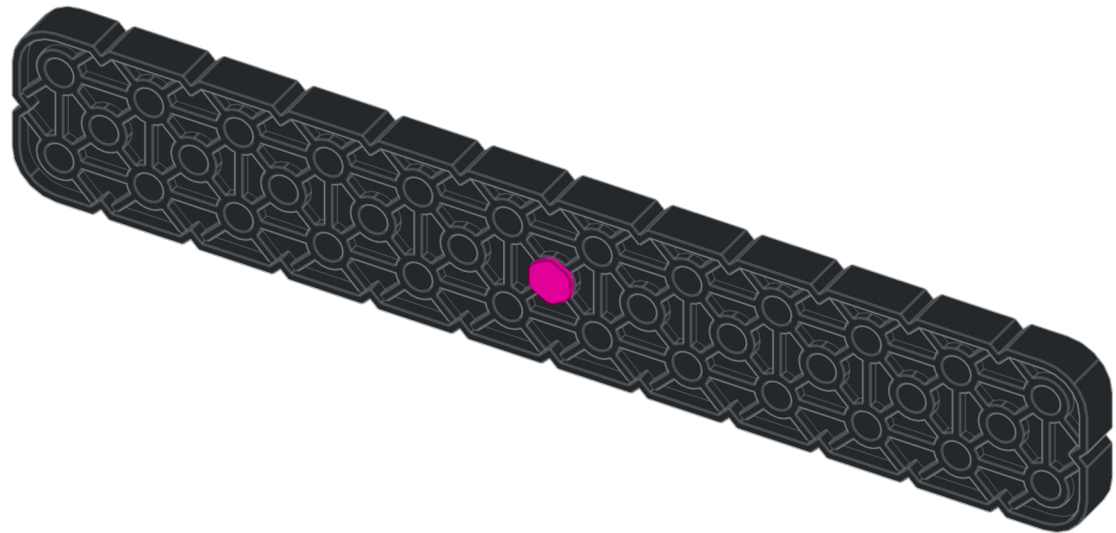
A legend box with a teal border containing two items: a pink pin and a black large beam. Below each item is its name and quantity: 'x1 Pink Pin' and 'x1 Black Large Beam'.

2

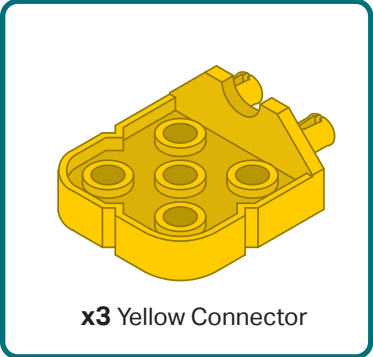
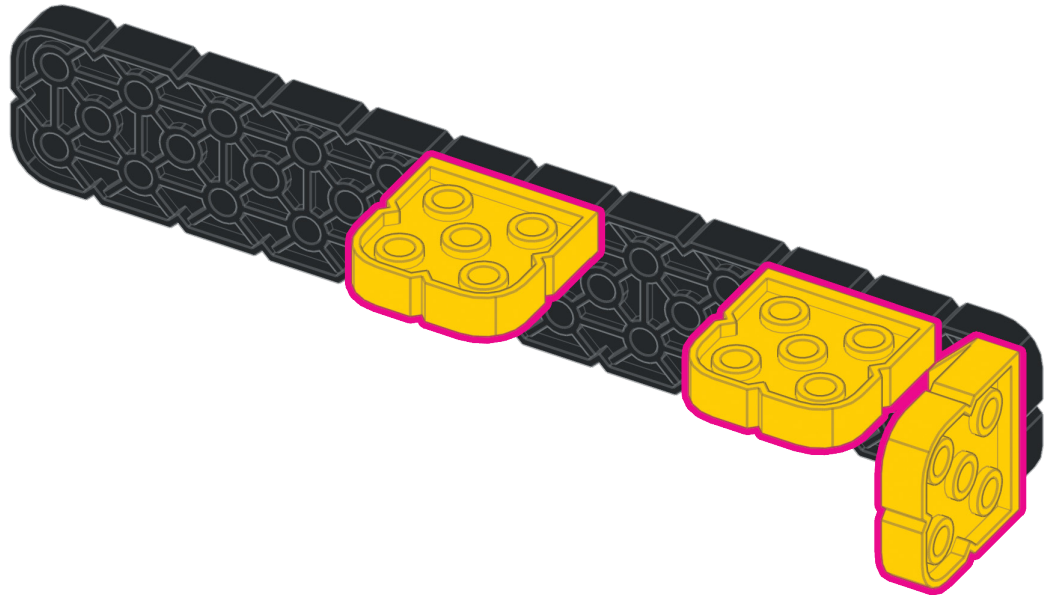
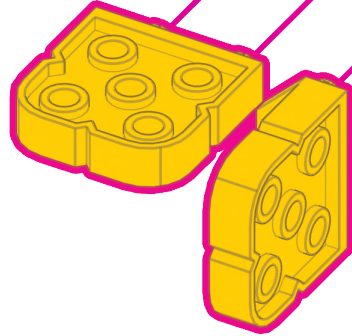
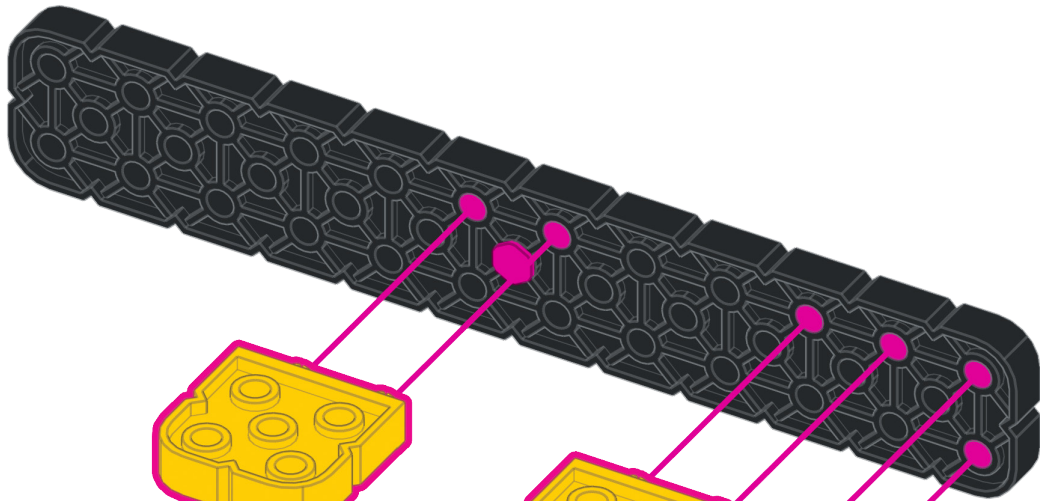

x3 Yellow Connector

3

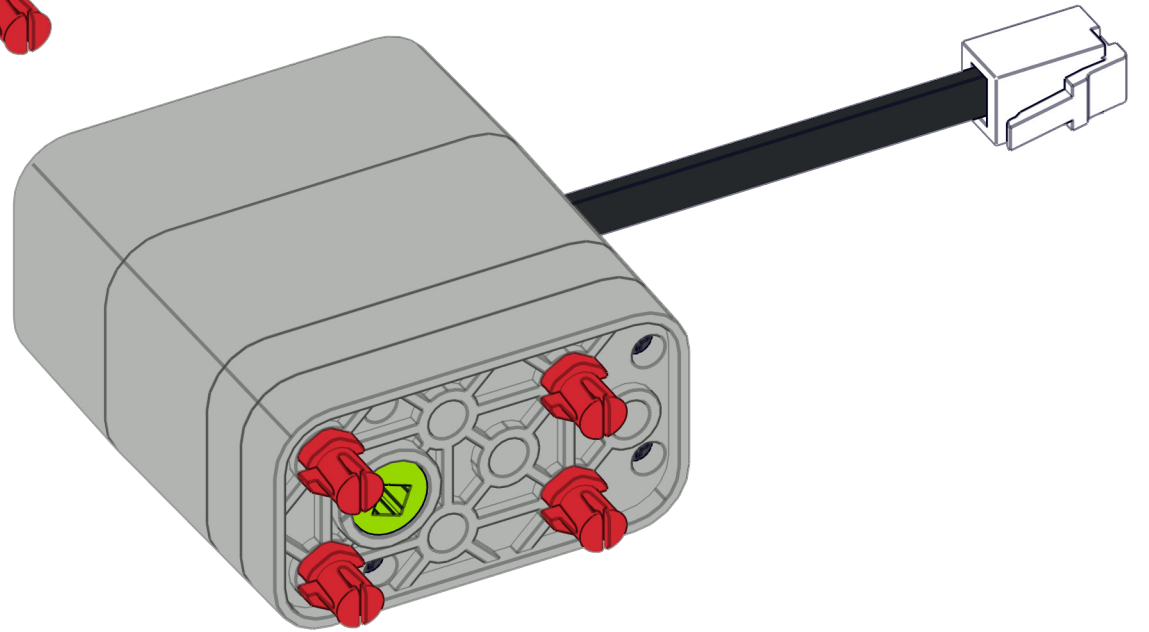
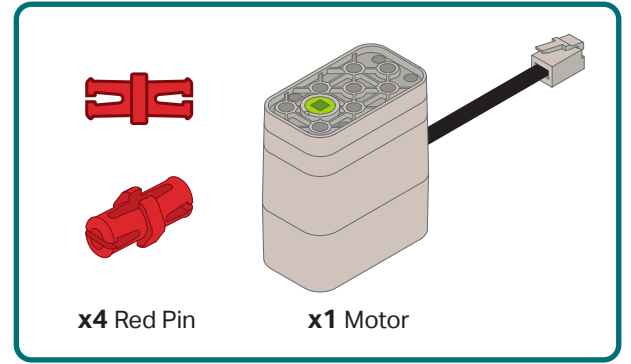
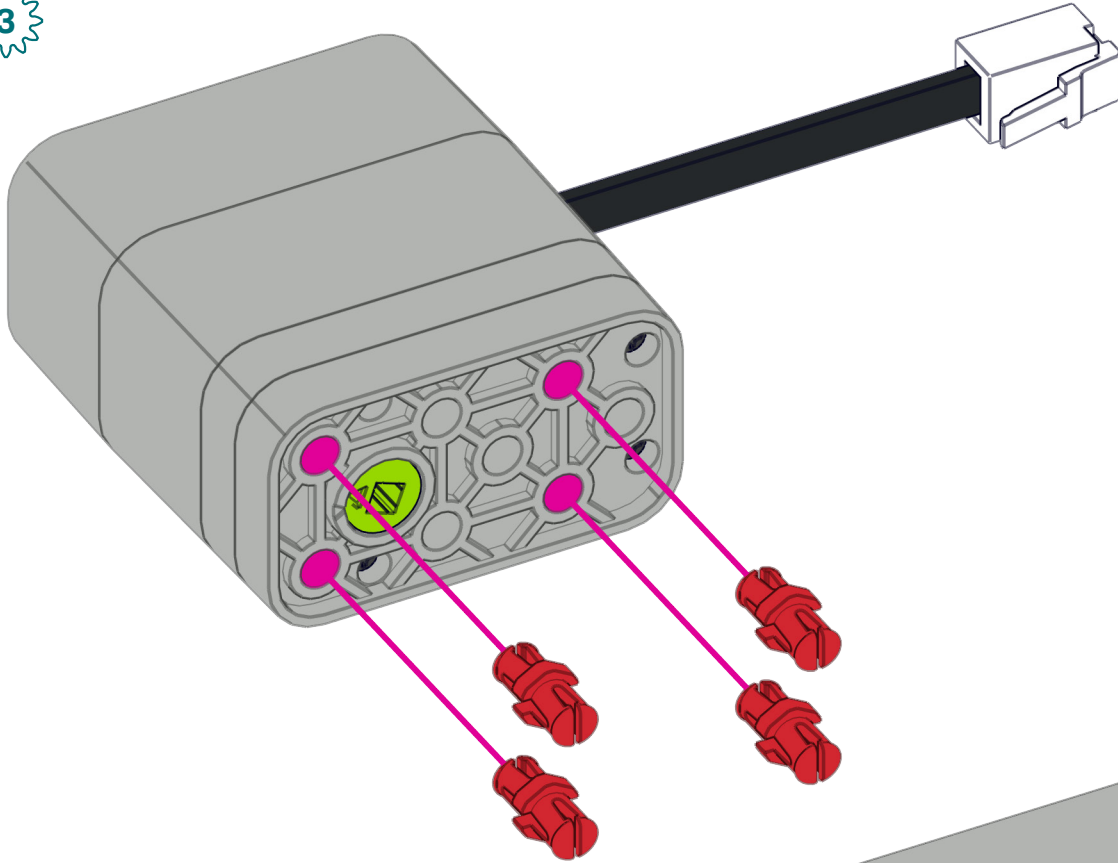

4

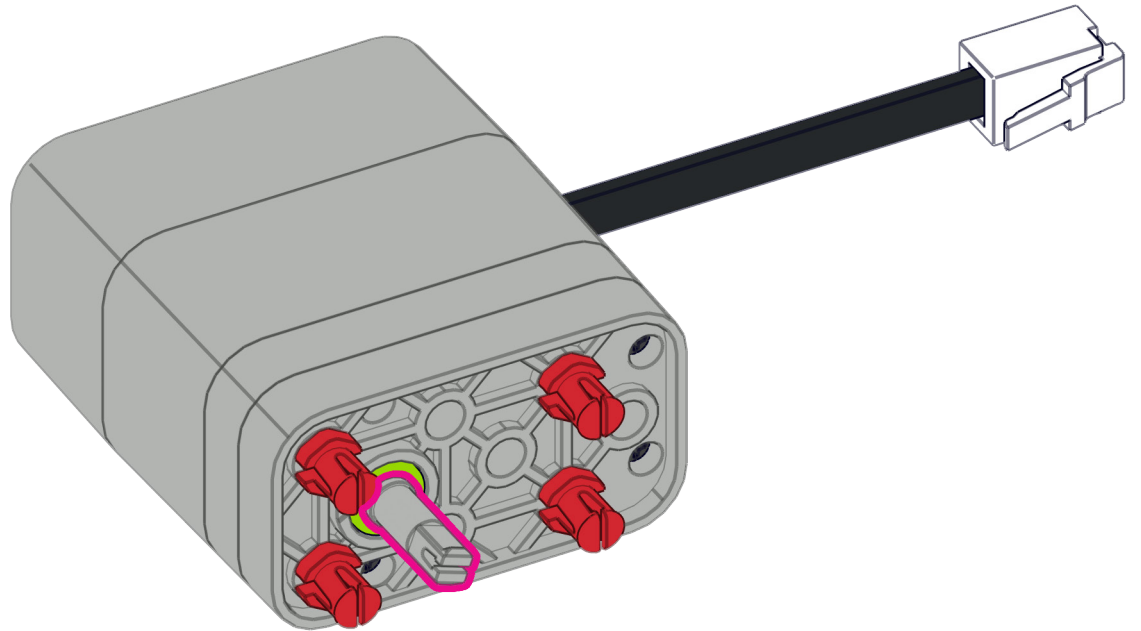
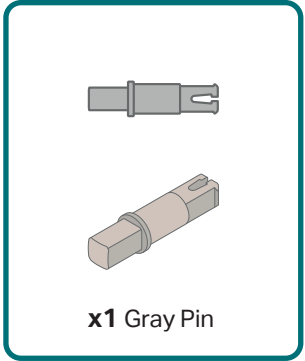
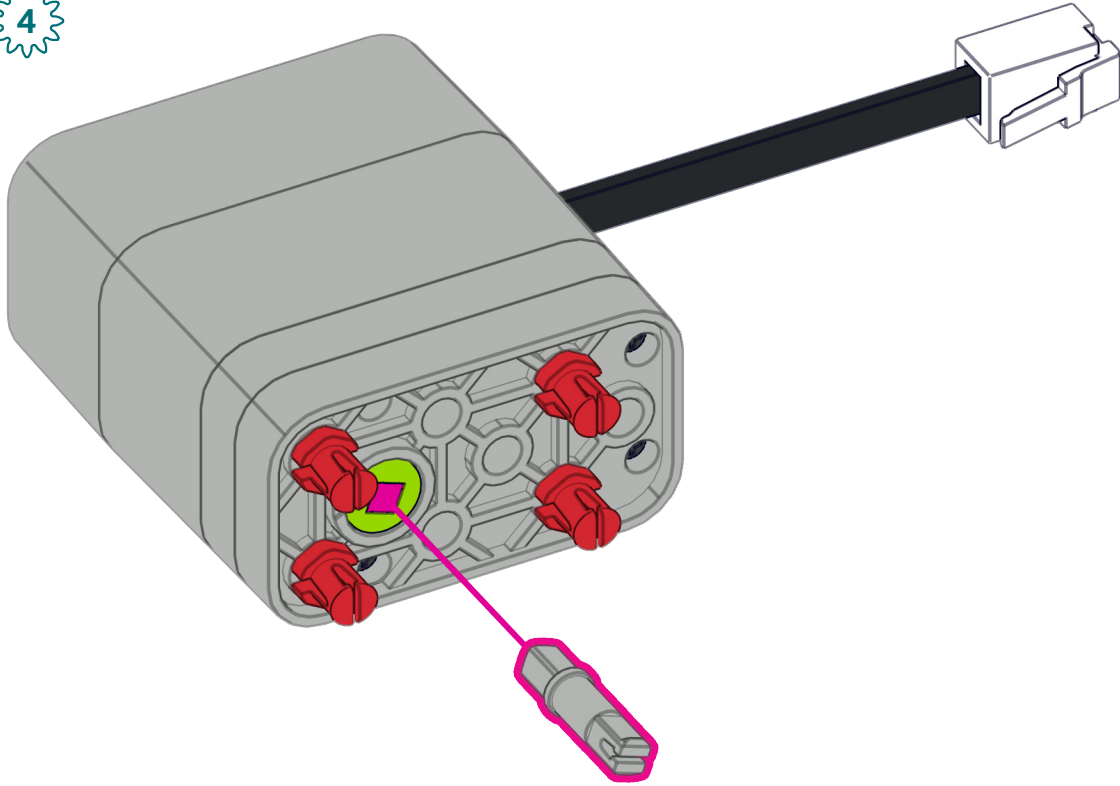

5

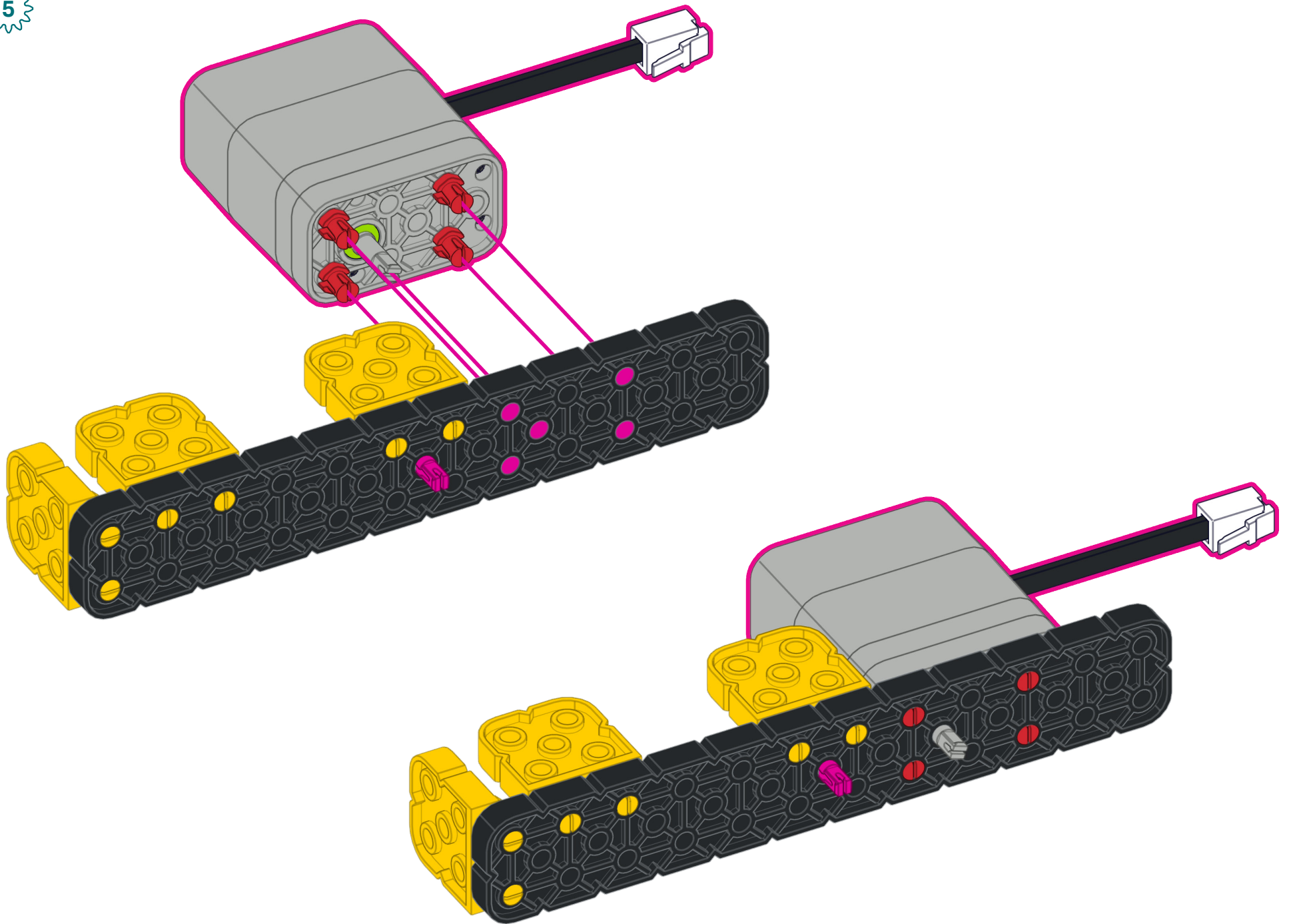

6

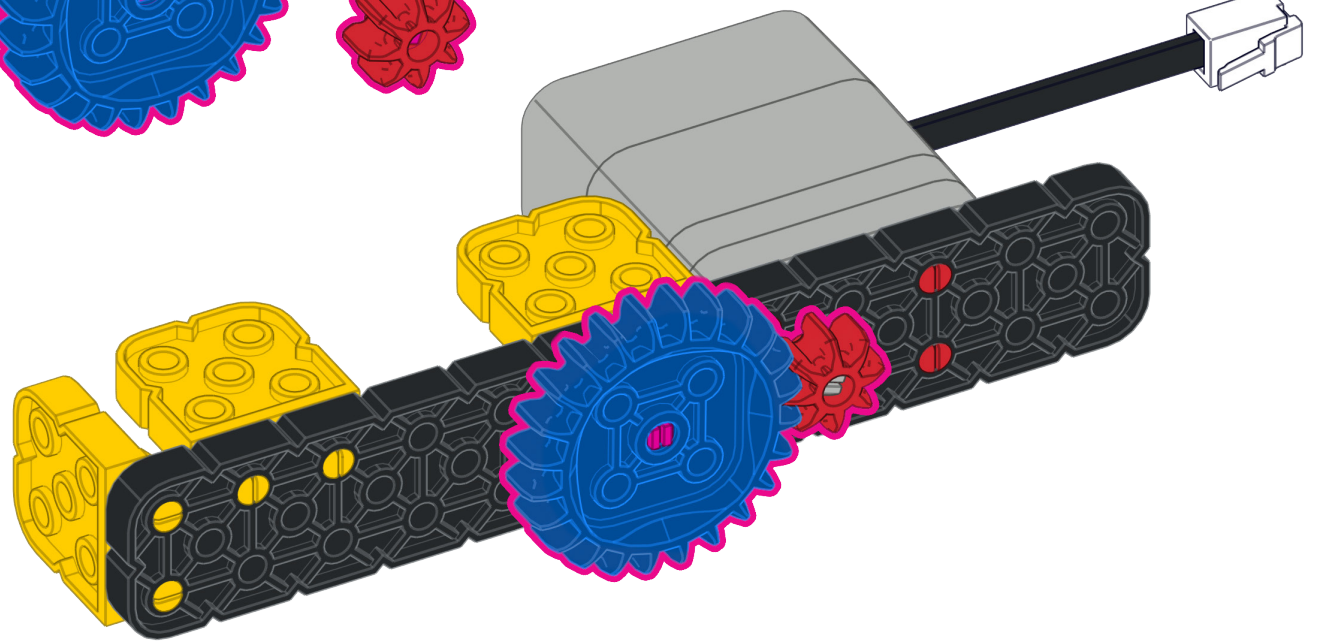
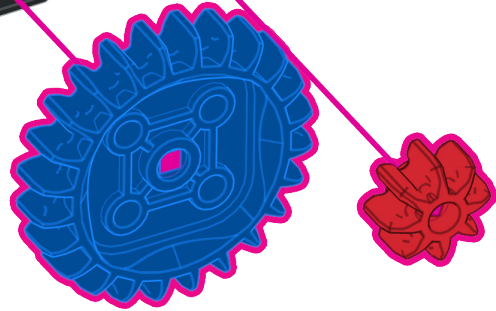
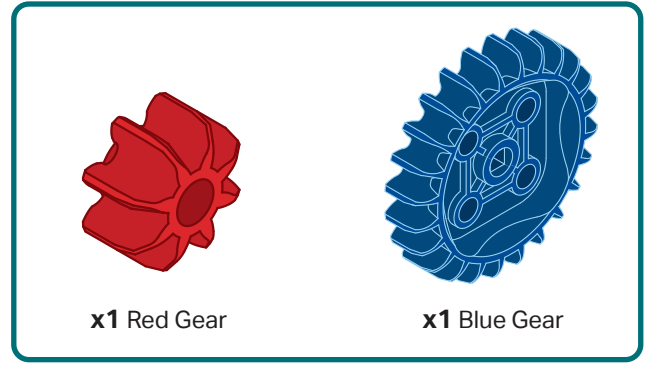
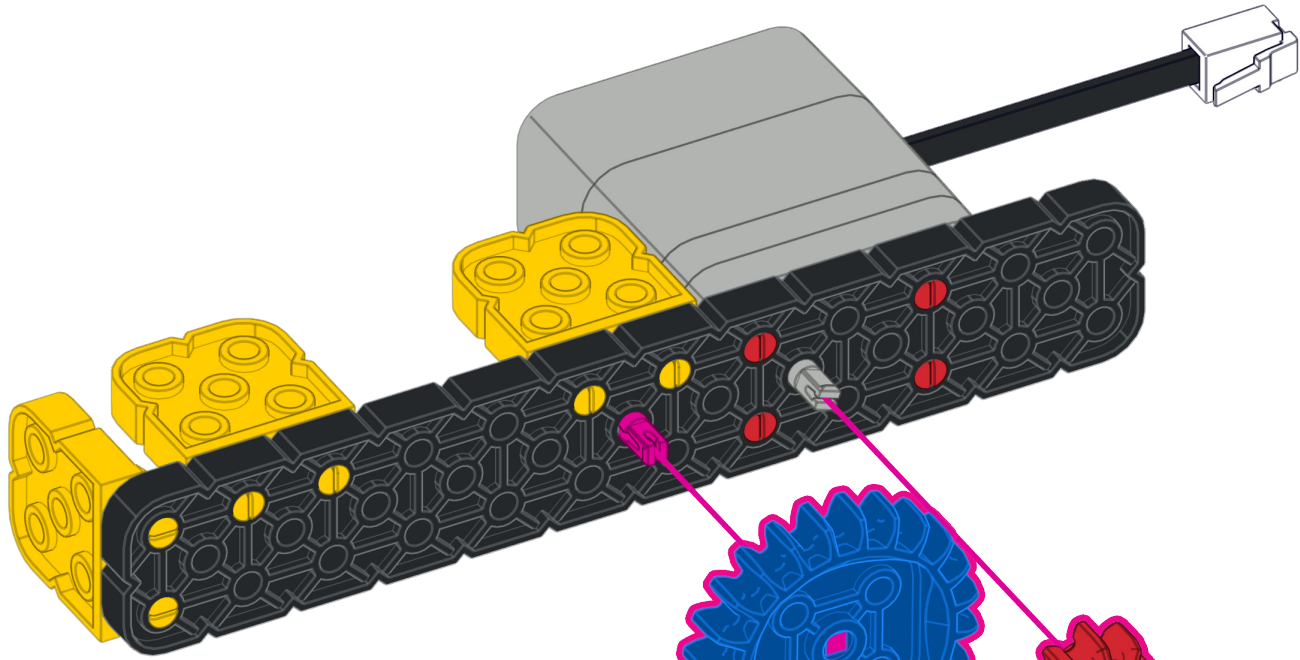

7

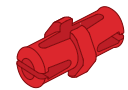
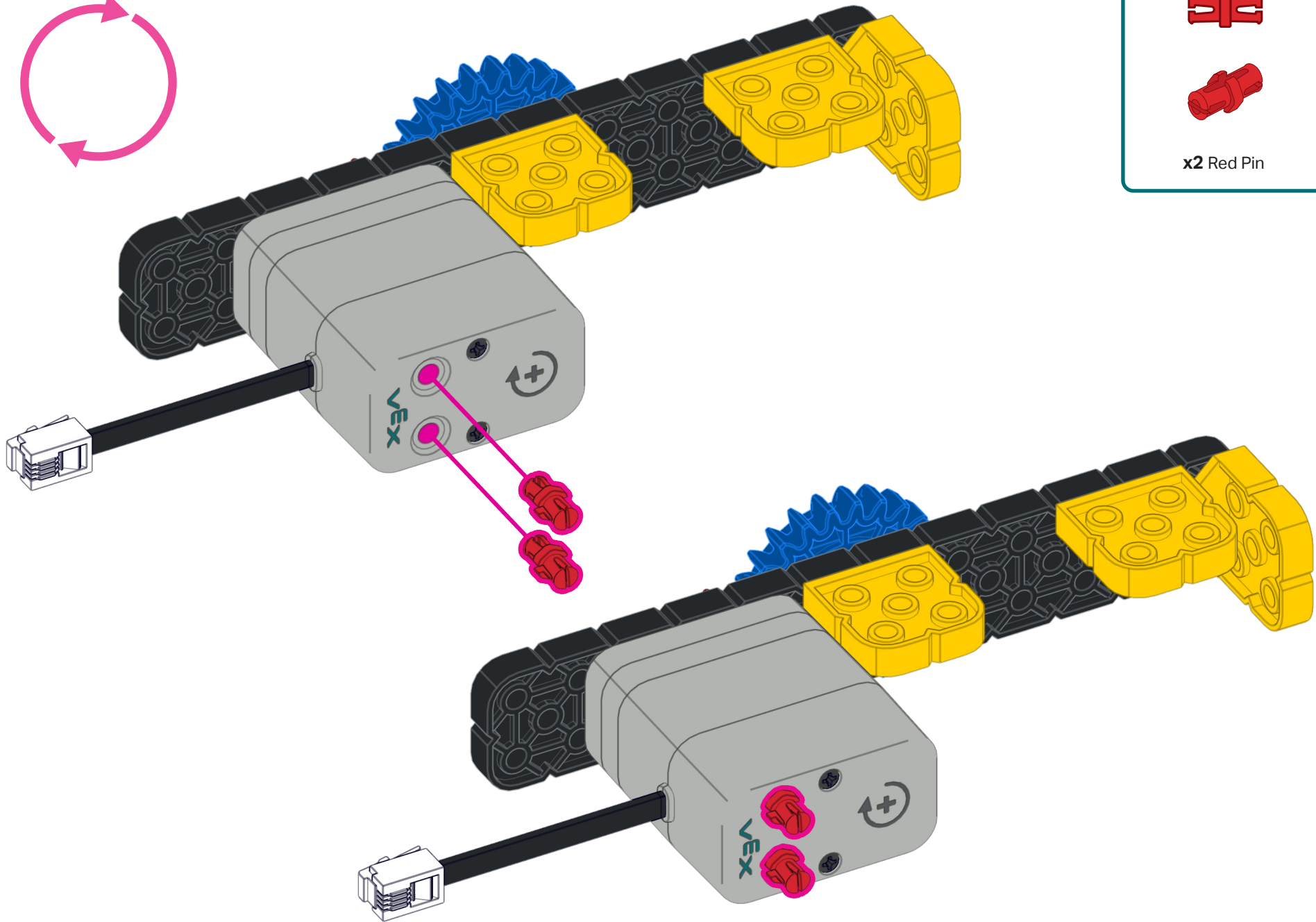
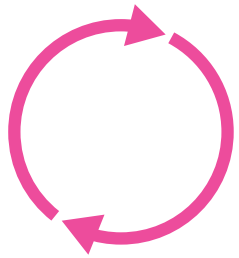

x2 Red Pin

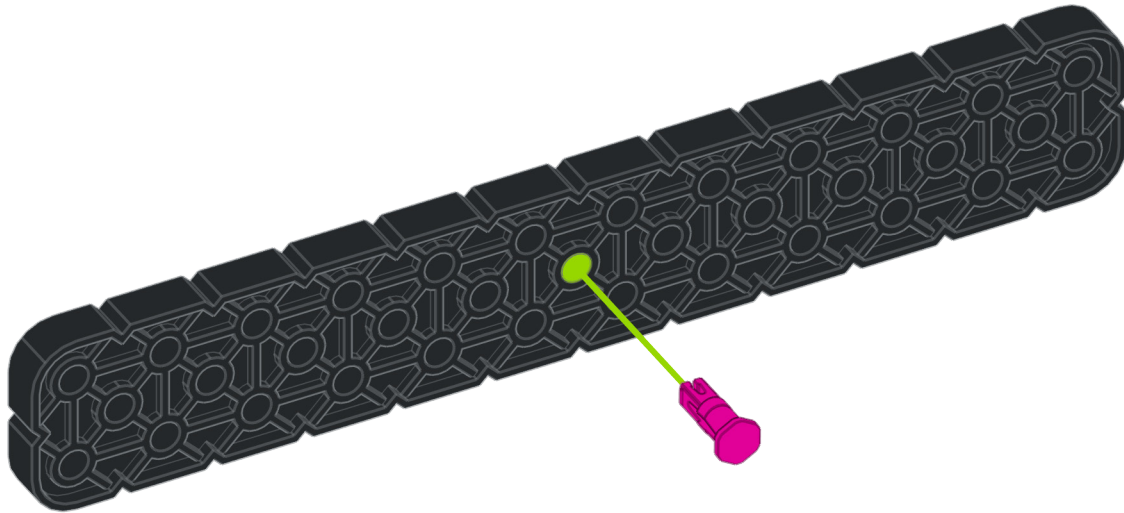

x1 Pink Pin

x1 Black Large Beam

A legend box with a teal border containing two items. On the left is a pink pin, and on the right is a black large beam. Below each item is its name and quantity: 'x1 Pink Pin' and 'x1 Black Large Beam'.

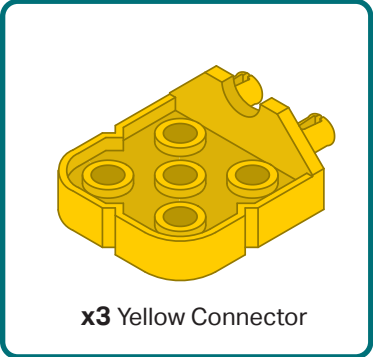
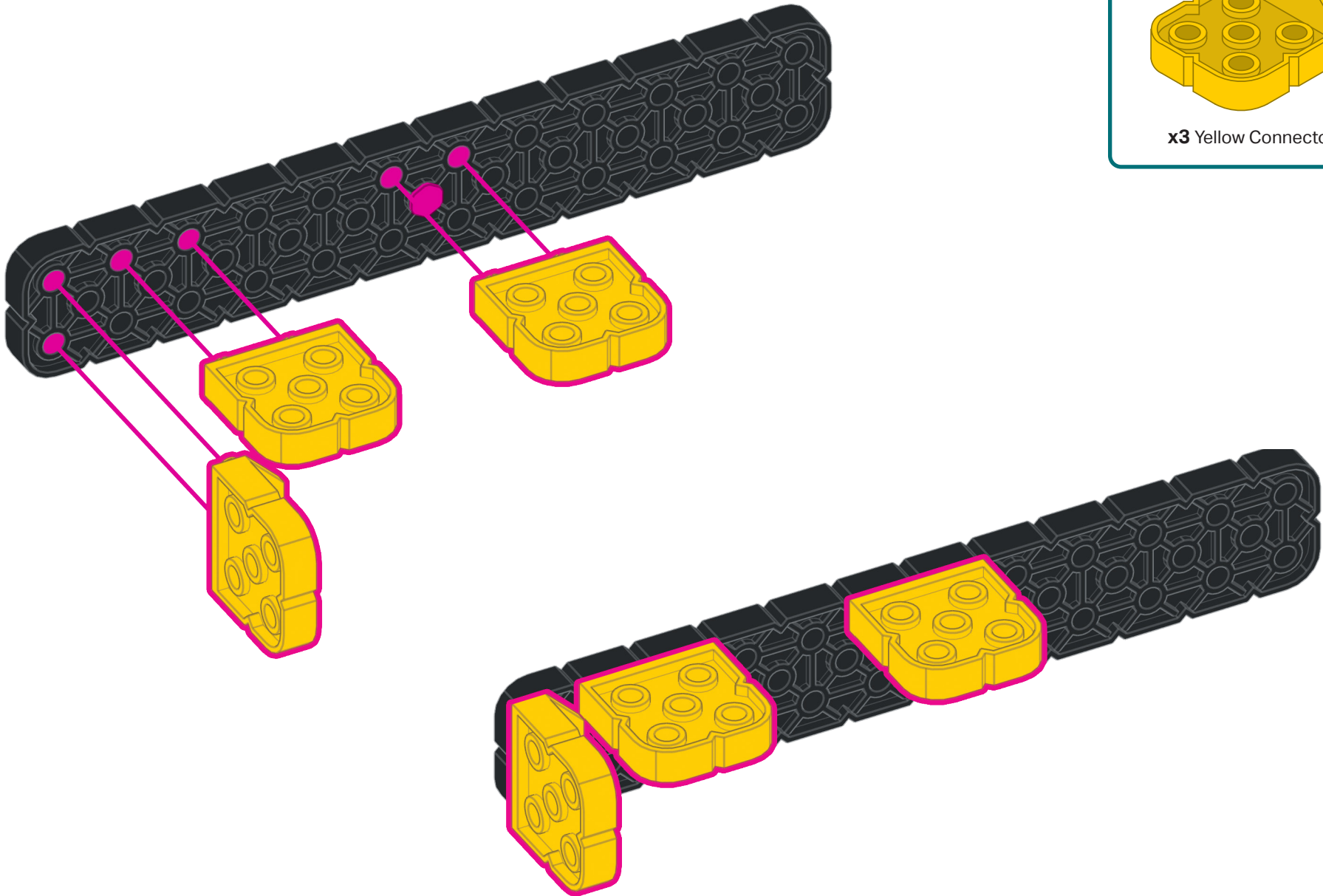

x3 Yellow Connector

10

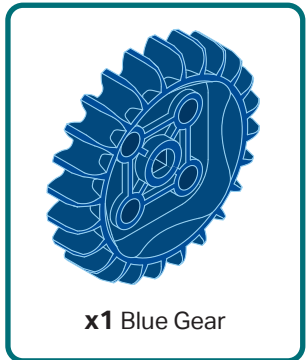
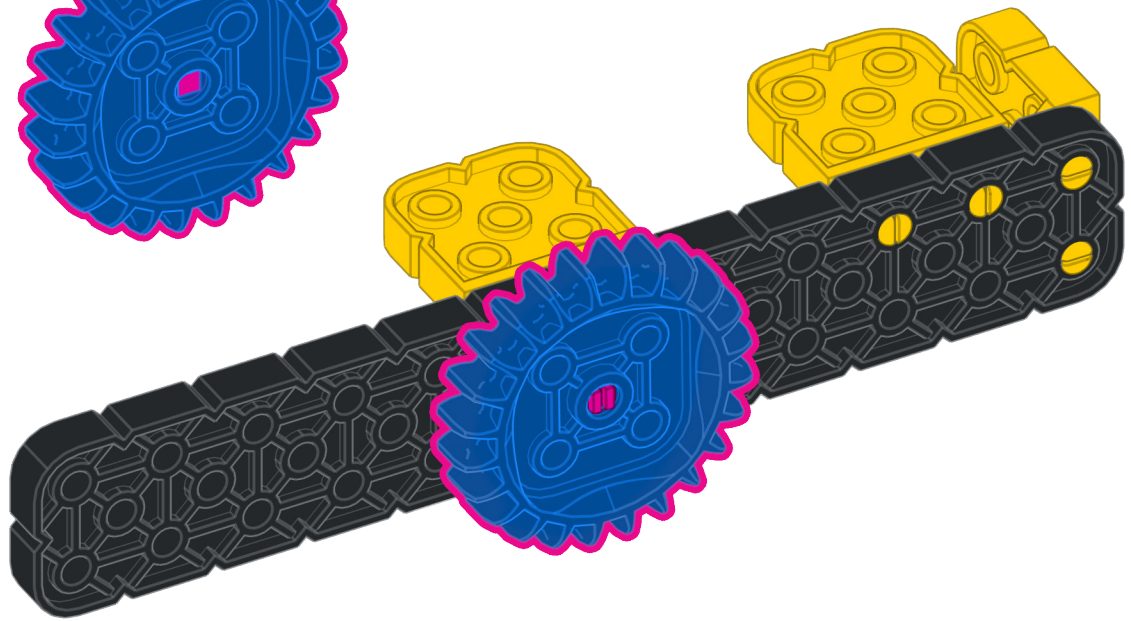
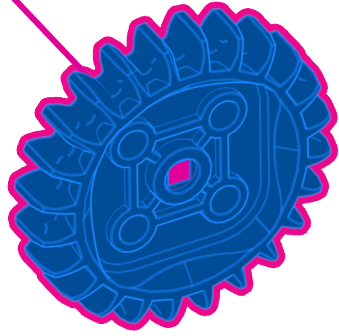
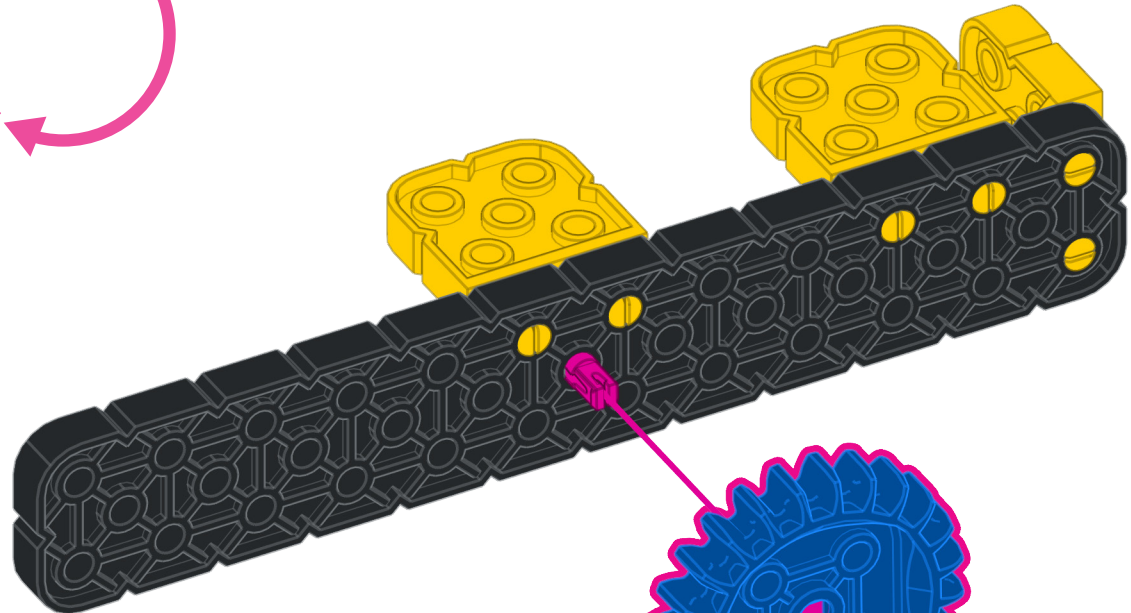
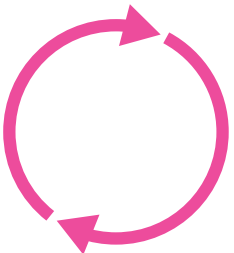

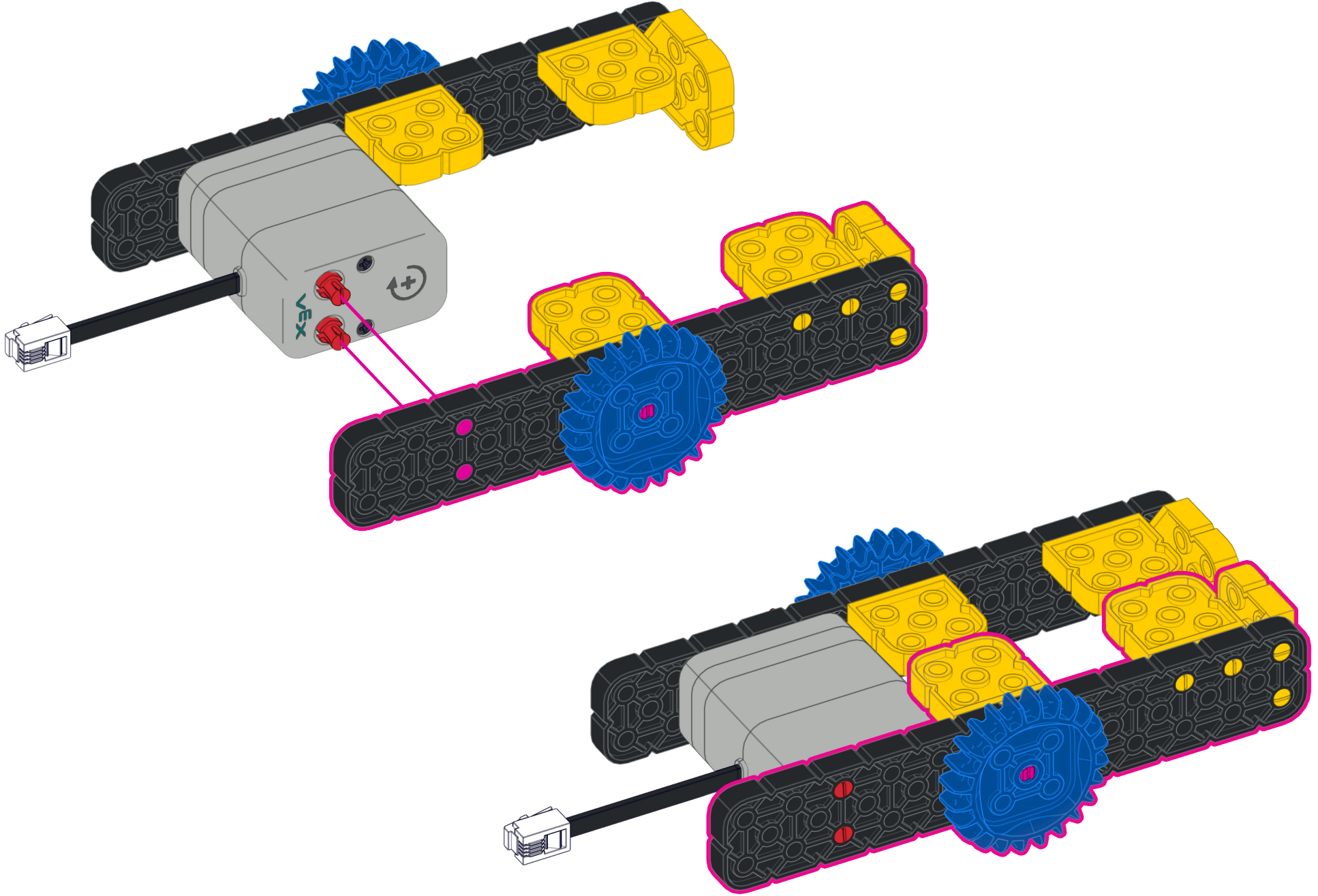

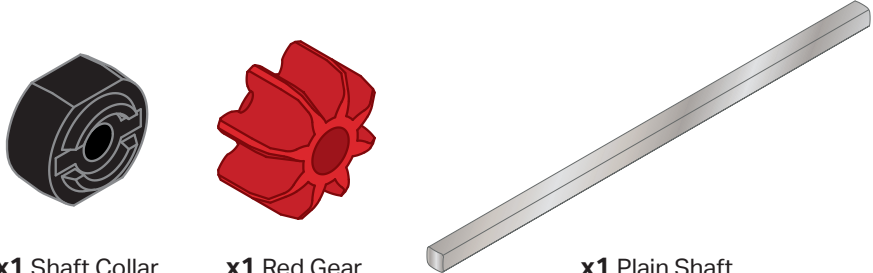

**x1** Shaft Collar      **x1** Red Gear      **x1** Plain Shaft

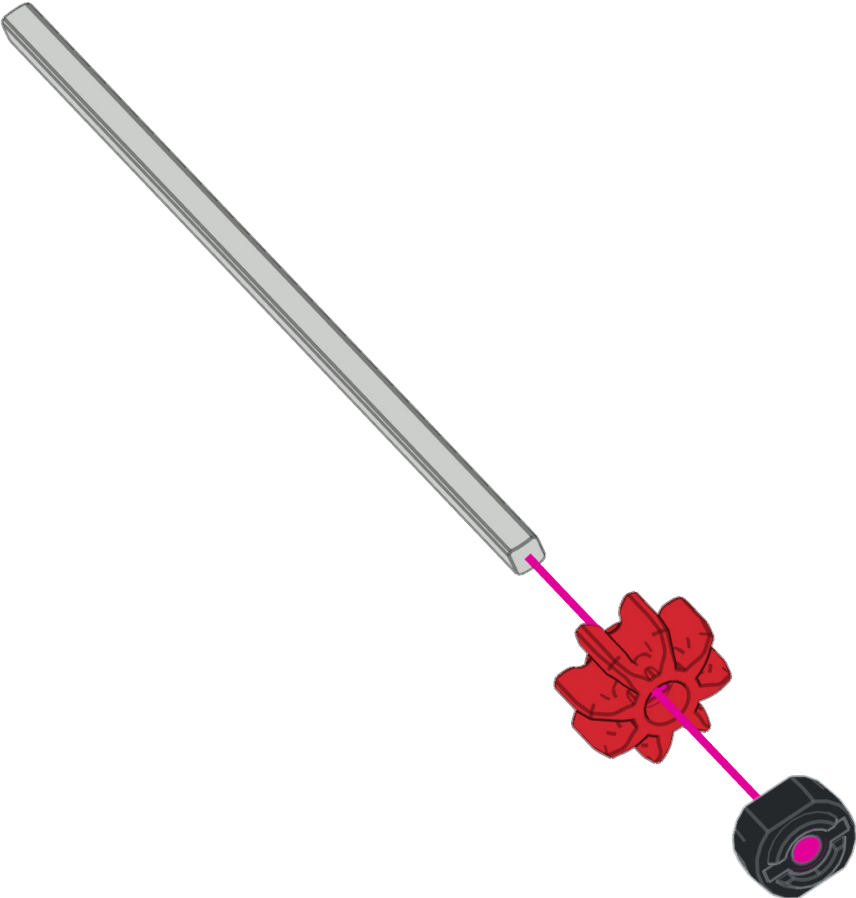

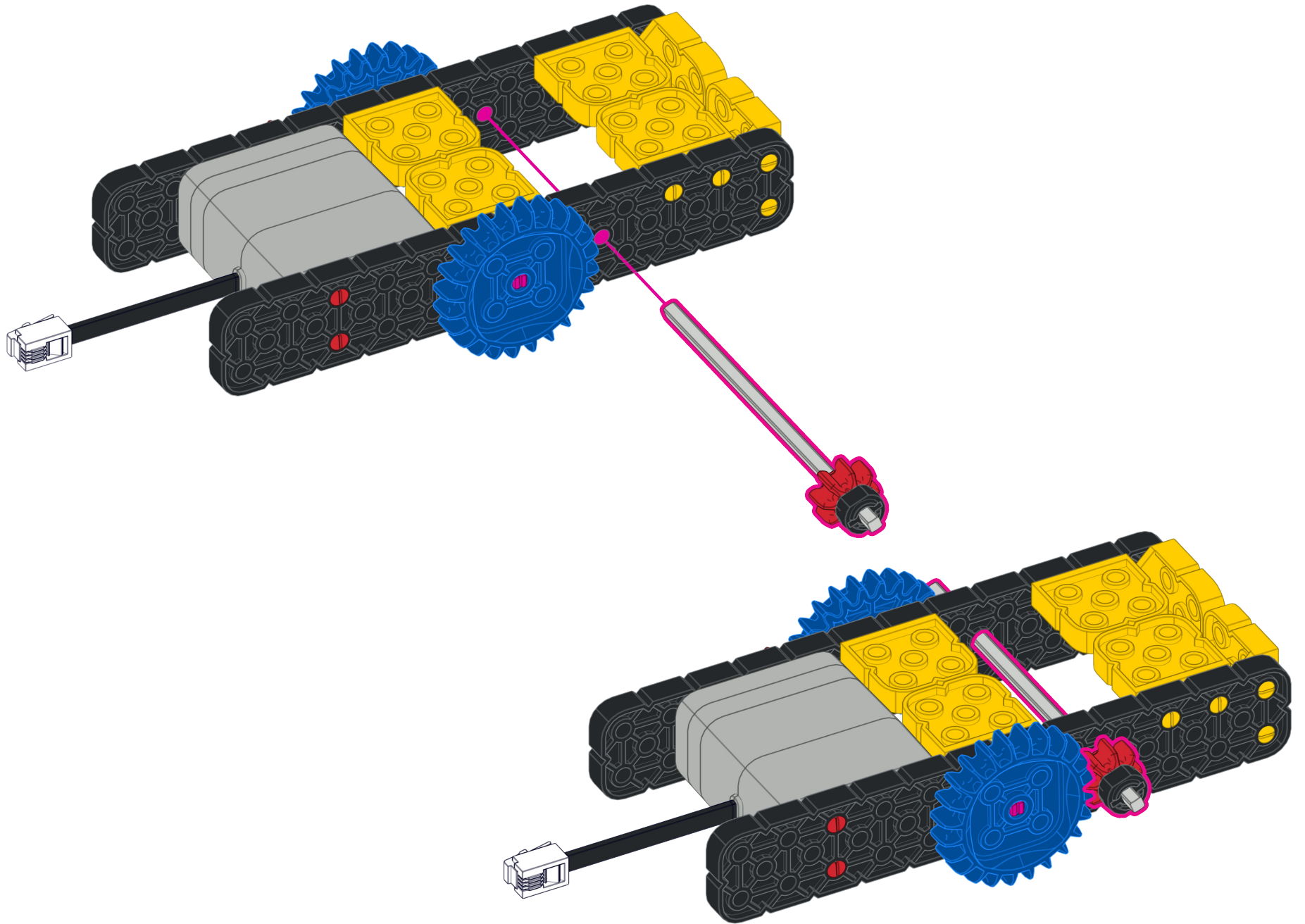

14

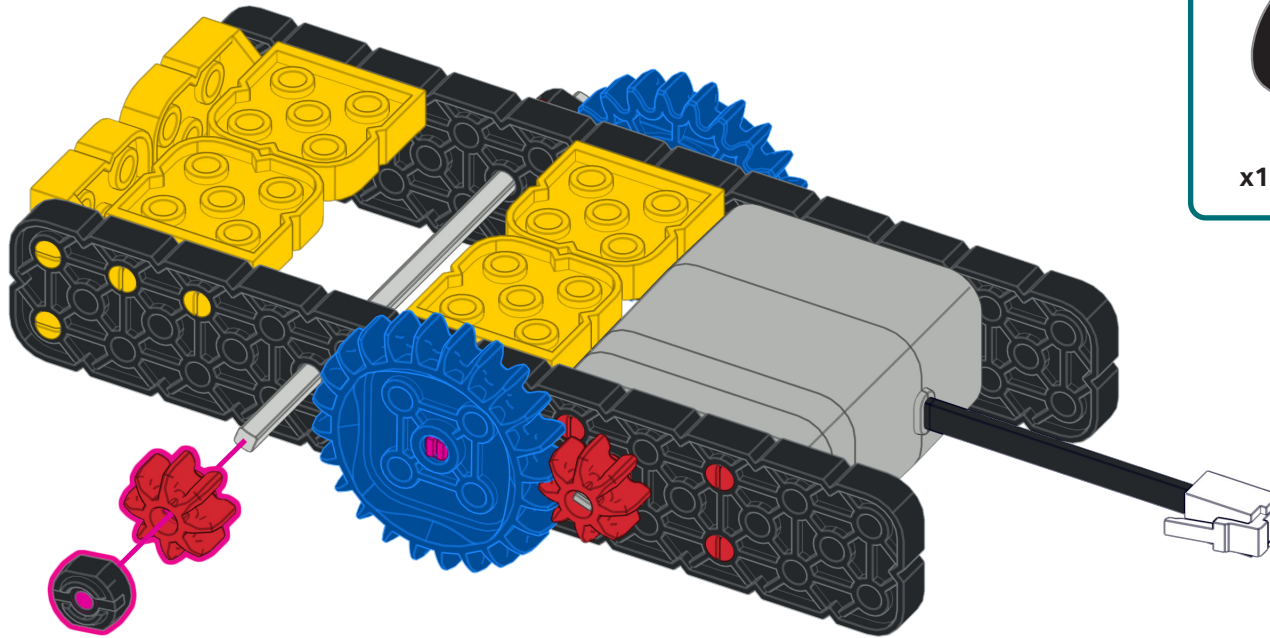
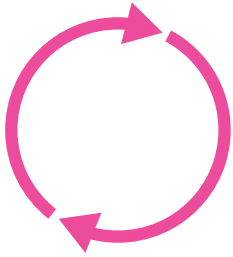

x1 Shaft Collar

x1 Red Gear

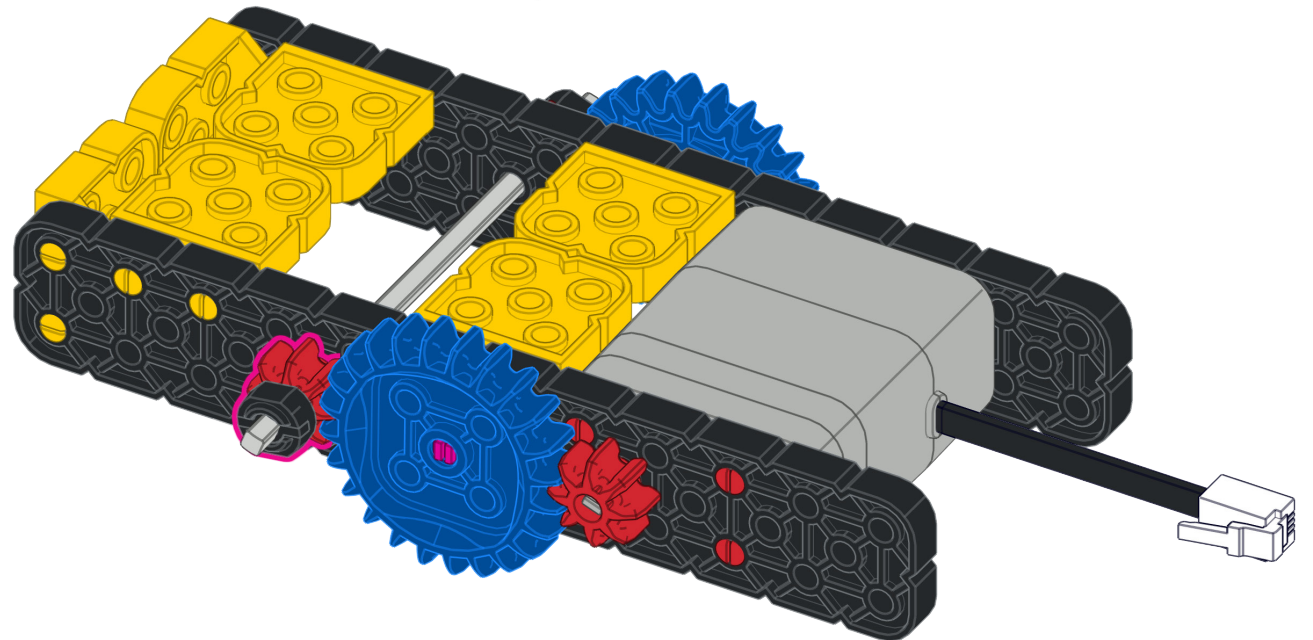

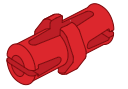
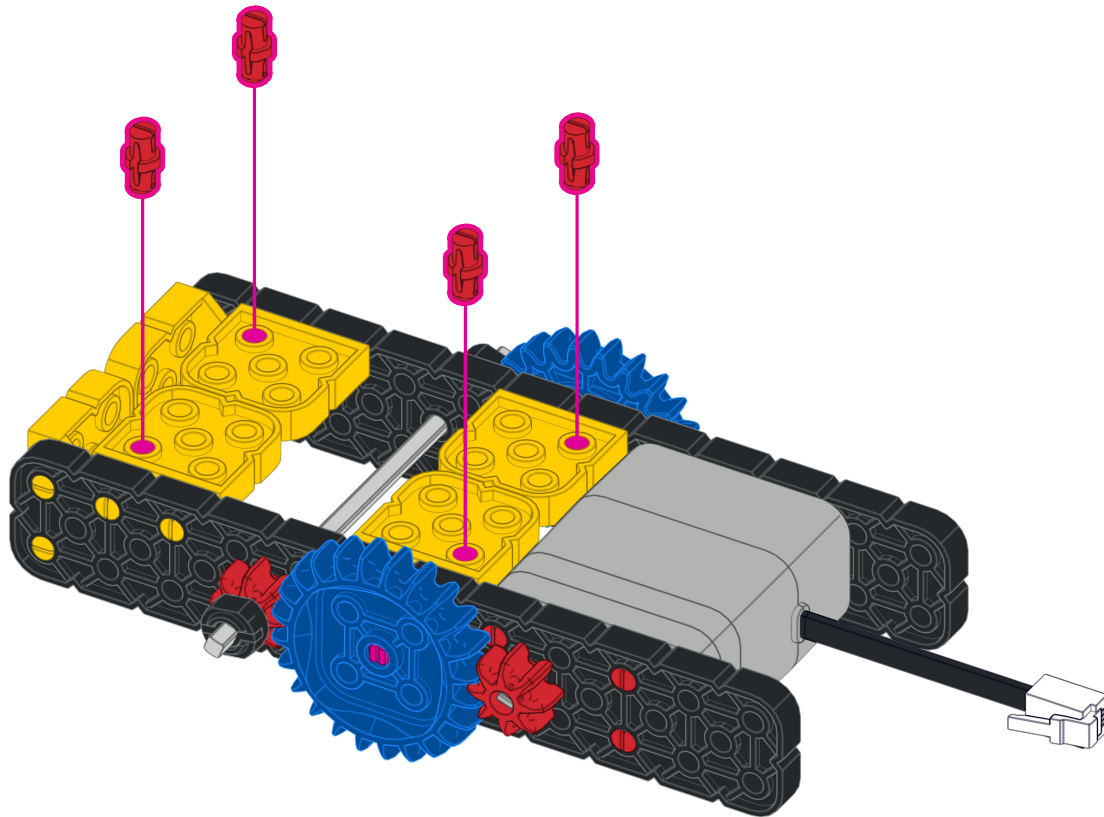

x4 Red Pin

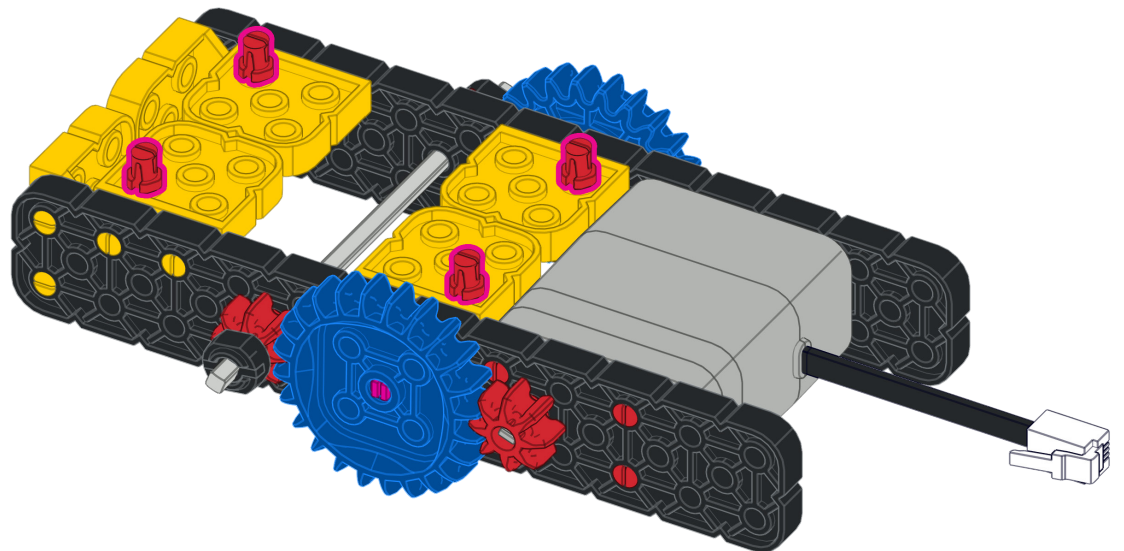

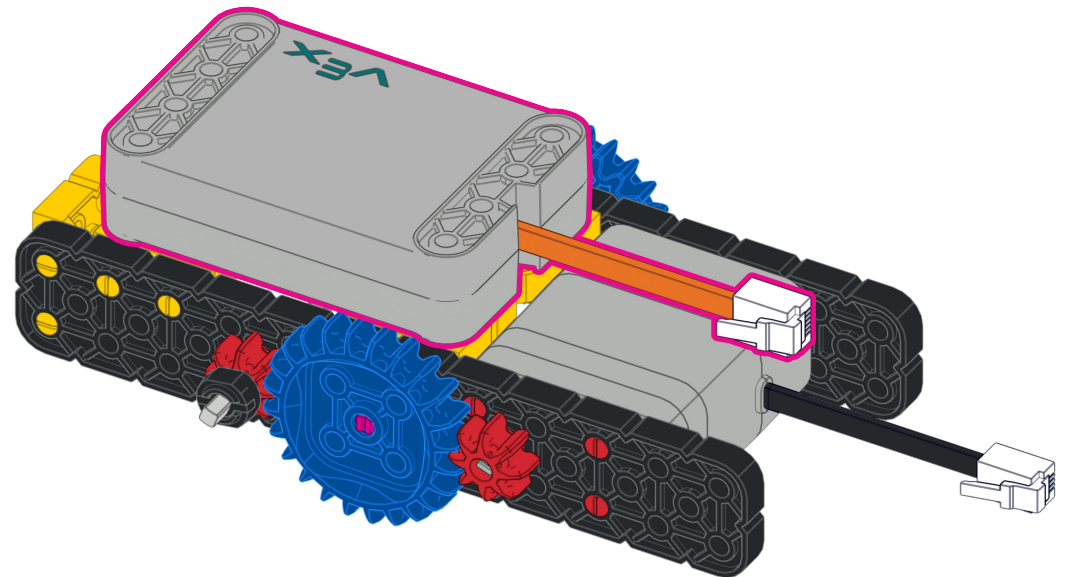
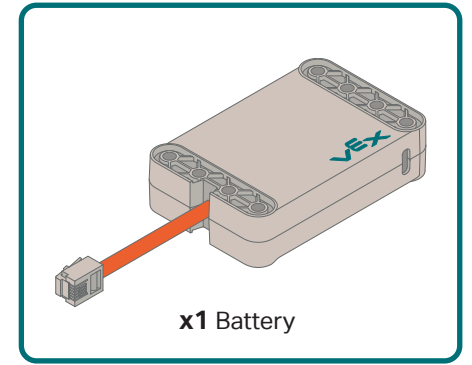
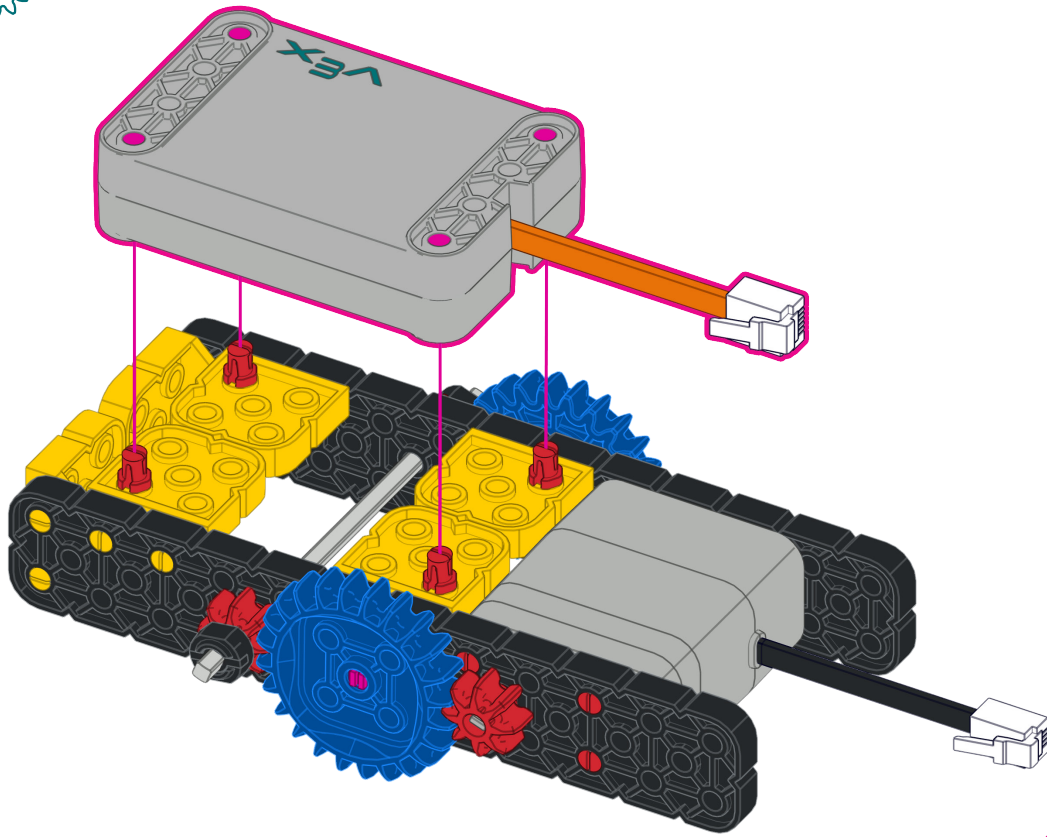

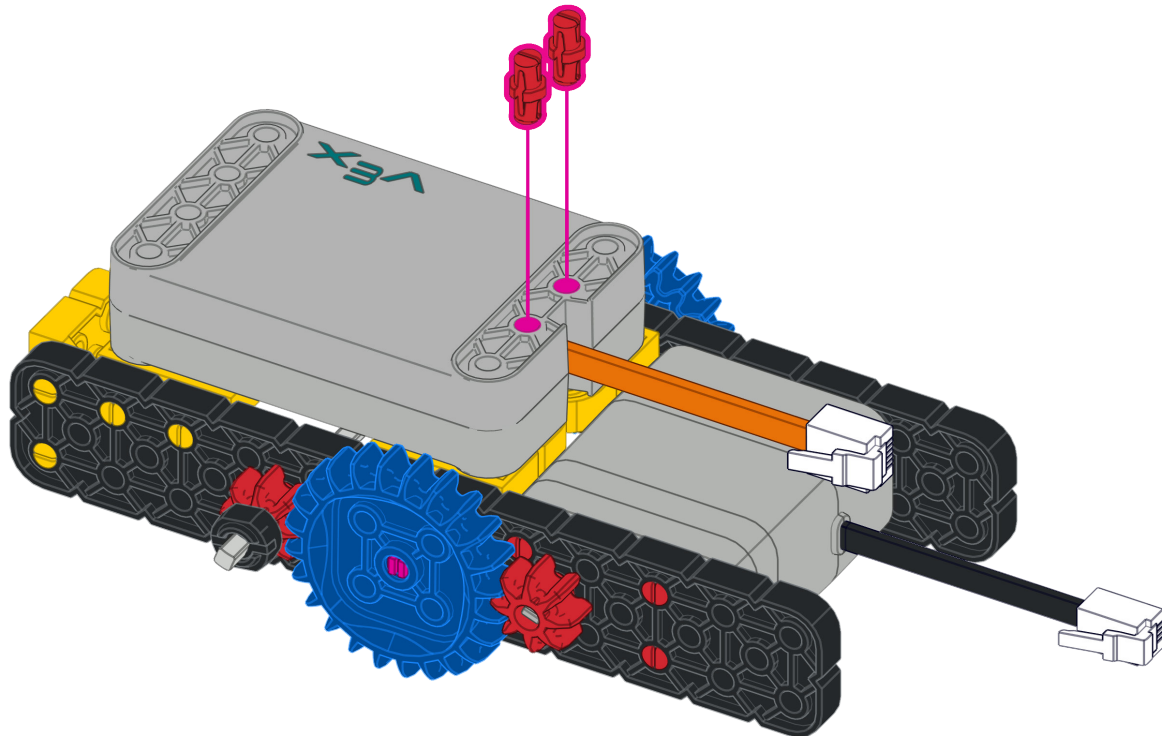

x2 Red Pin

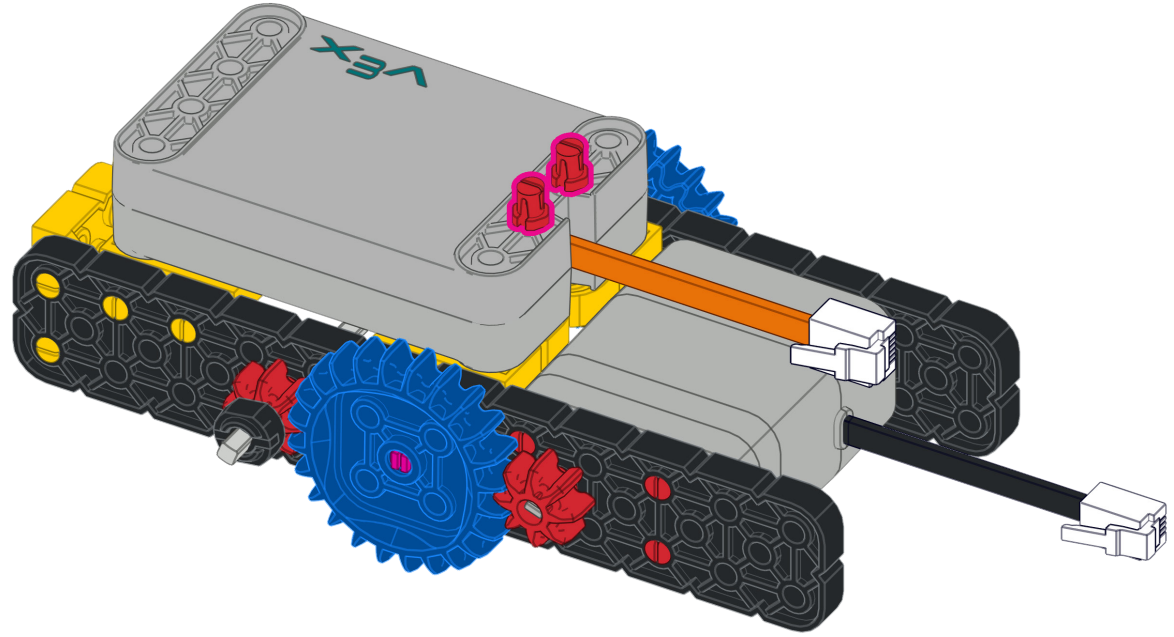

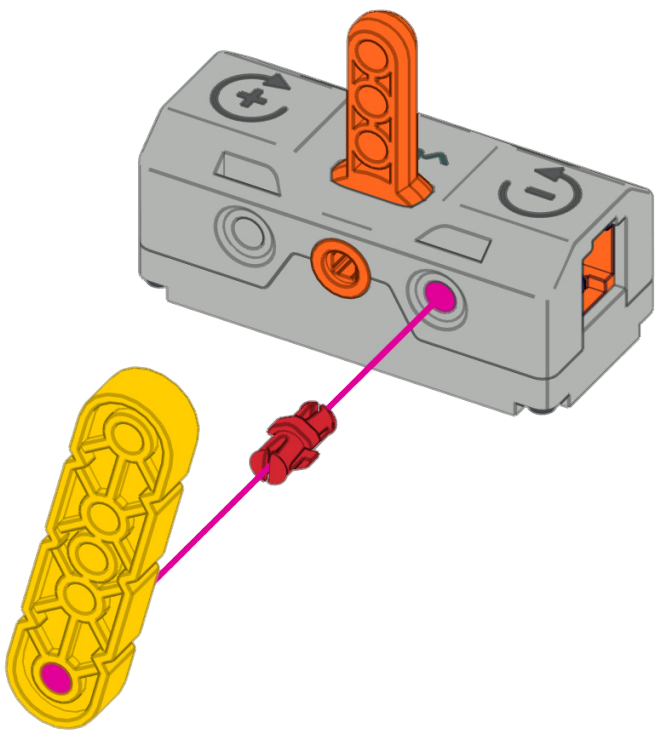

x1 Yellow Beam      x1 Red Pin      x1 Switch

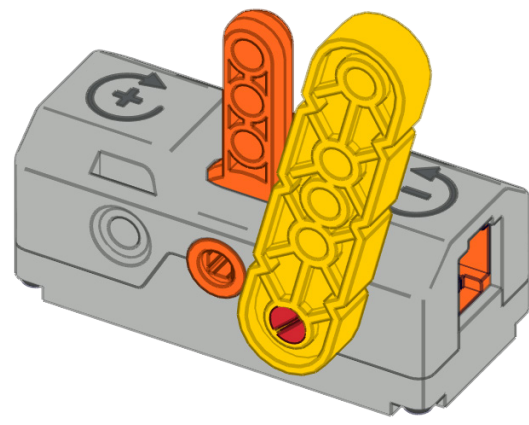
A parts list diagram enclosed in a teal border. It shows three items: a yellow beam, a red pin, and a grey switch component with an orange tab. Below each item is its name and quantity: 'x1 Yellow Beam', 'x1 Red Pin', and 'x1 Switch'.

19

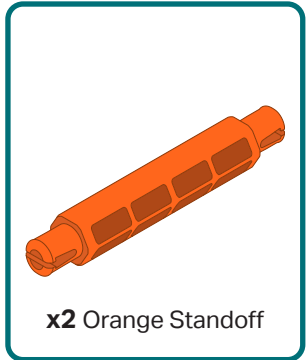
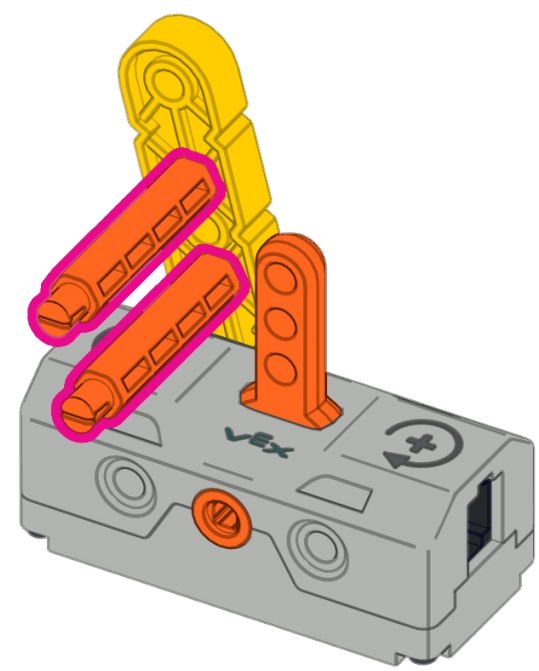
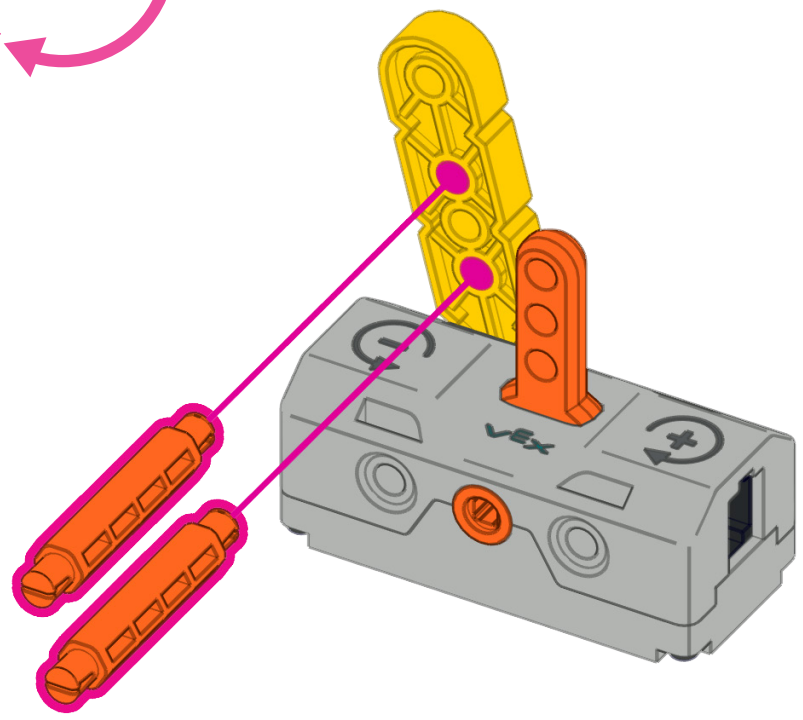
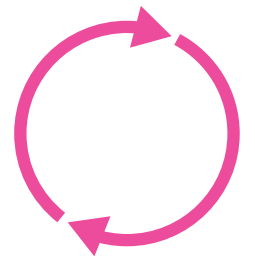

x2 Orange Standoff

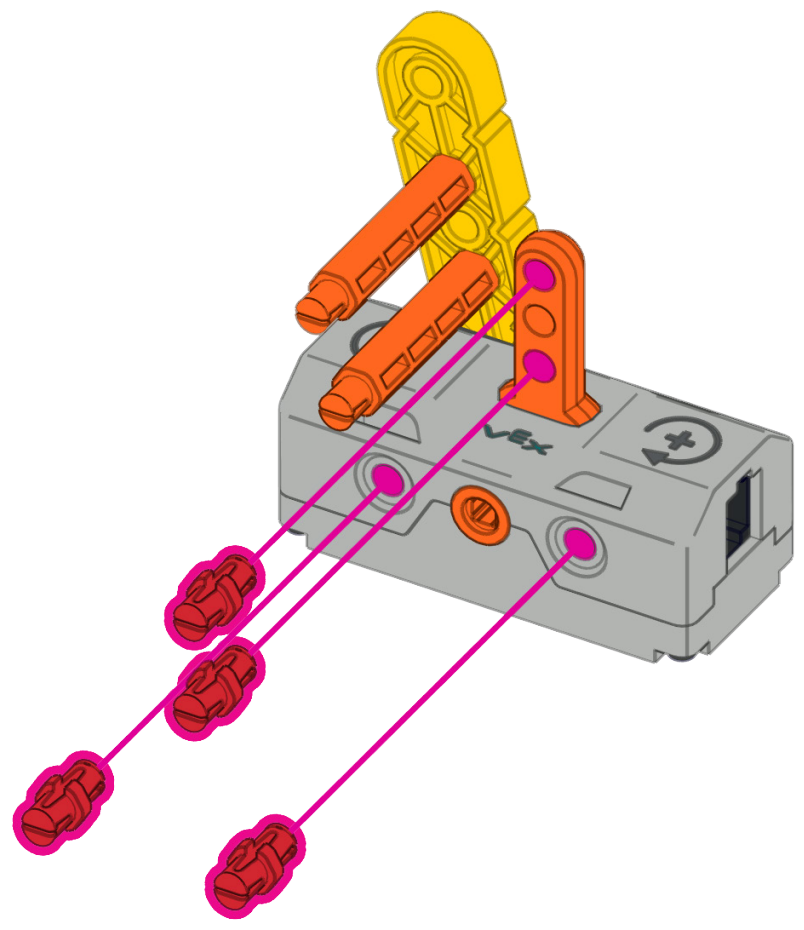

A legend box with a teal border containing two red pin components: a red T-shaped pin and a red cylindrical pin. Below the pins is the text "x4 Red Pin".

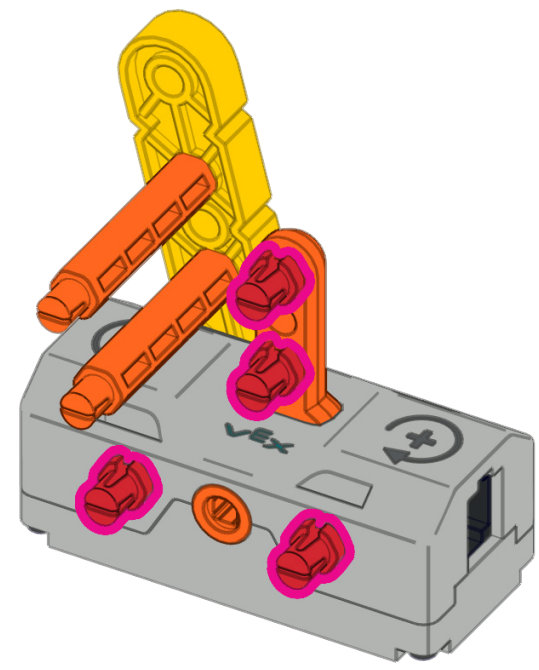

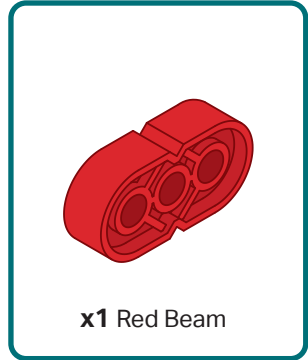
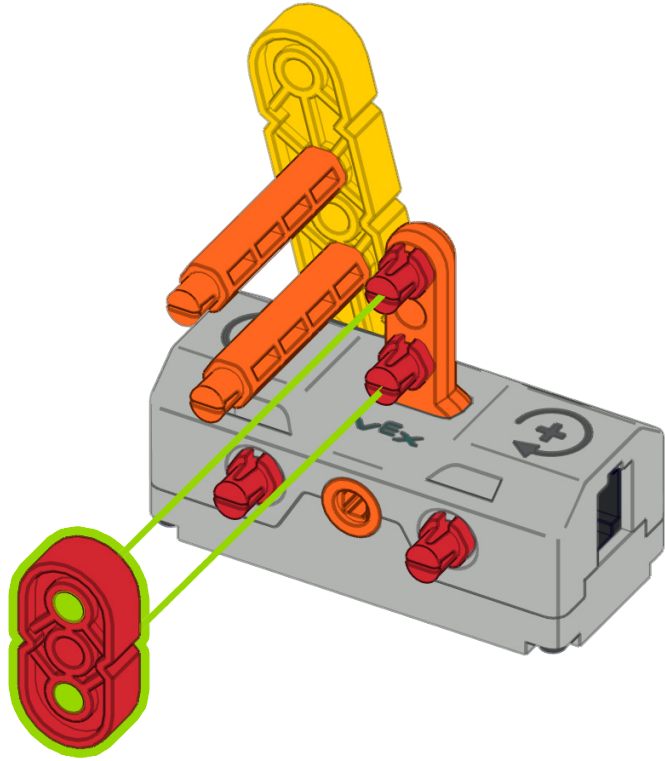

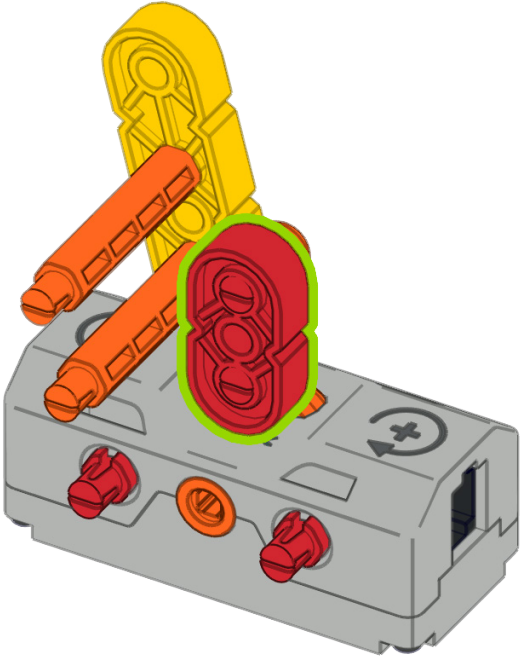

x1 Red Beam

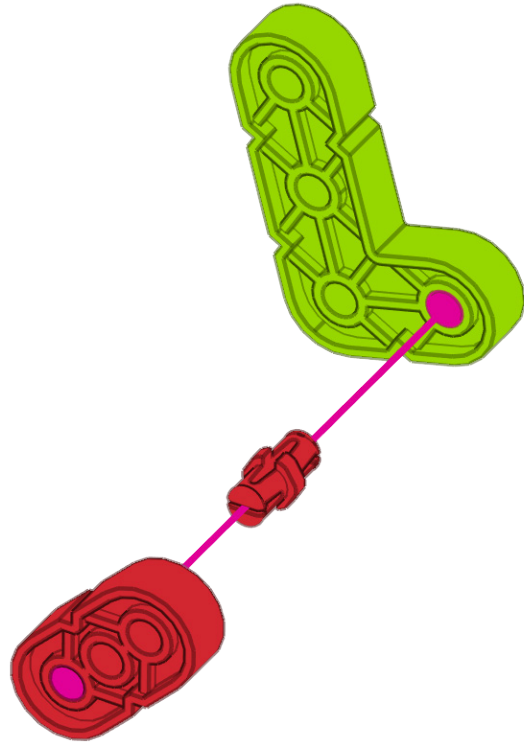

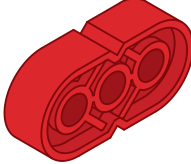

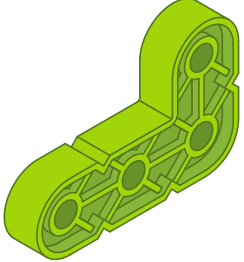
		
x1 Red Beam	x1 Red Pin	x1 Green Angle Beam

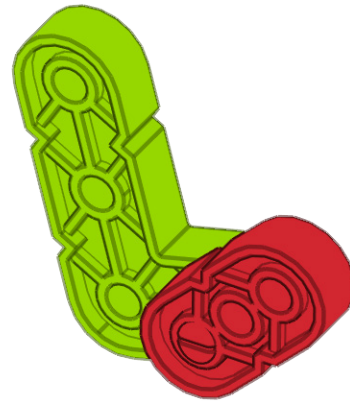

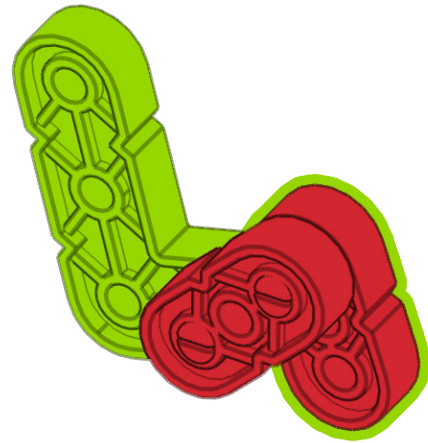
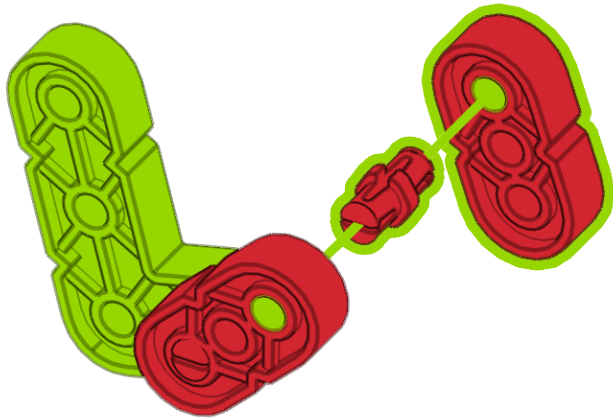
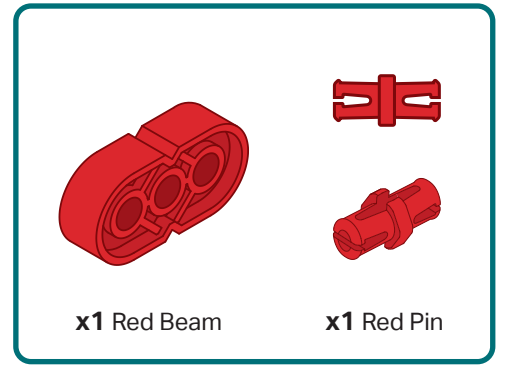

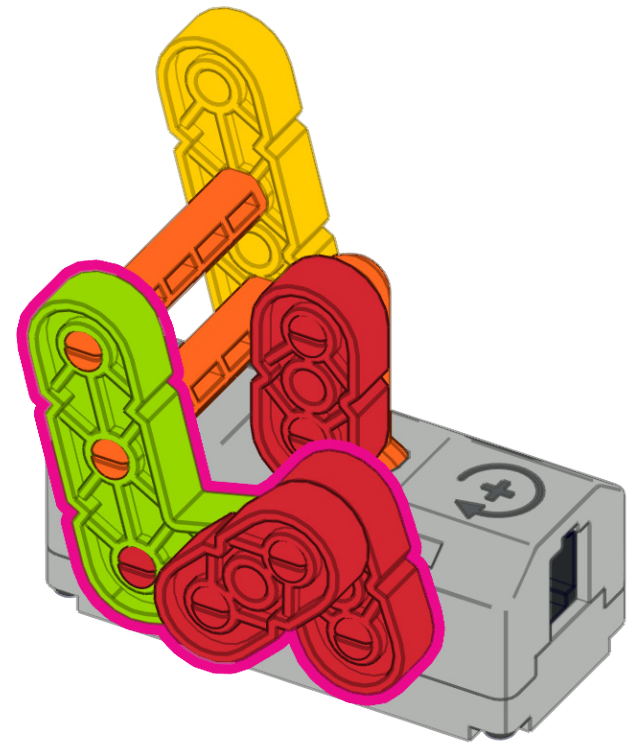
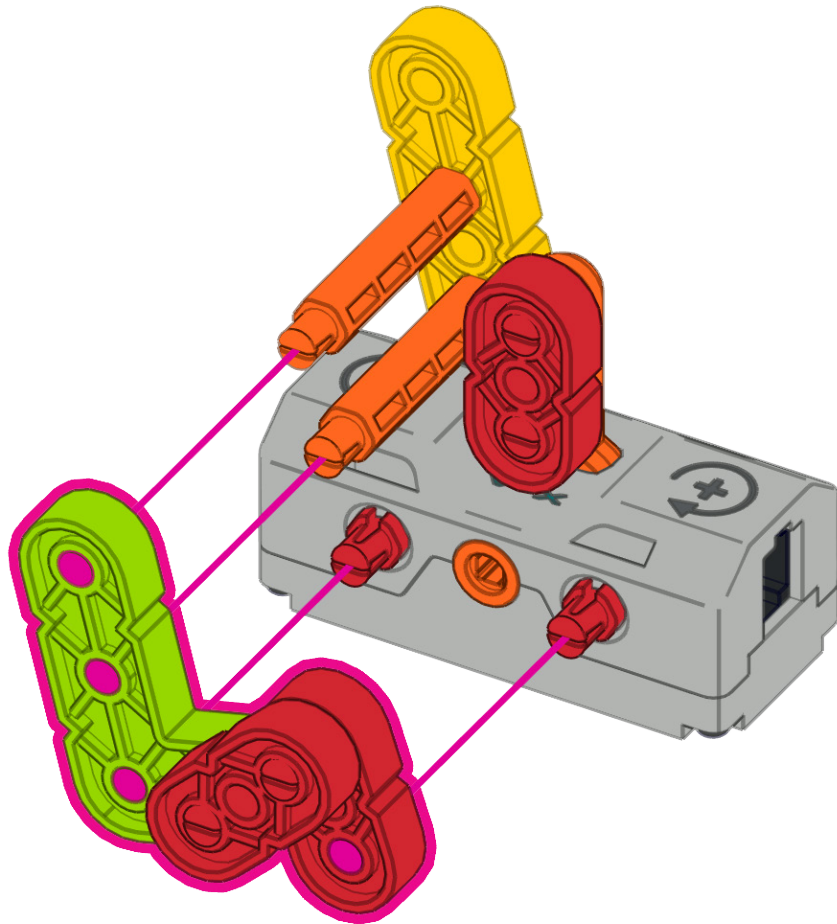

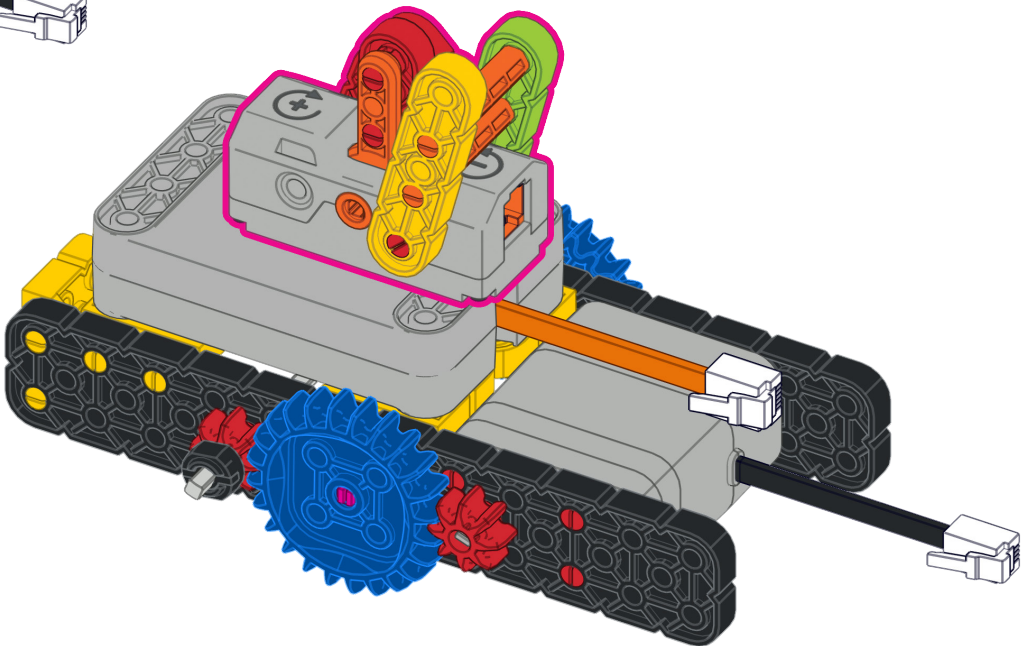
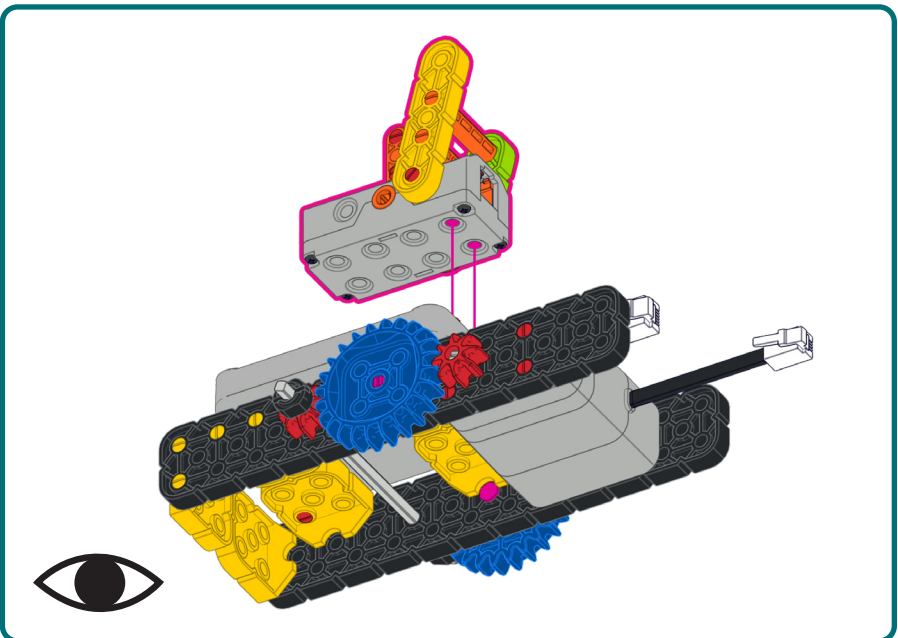
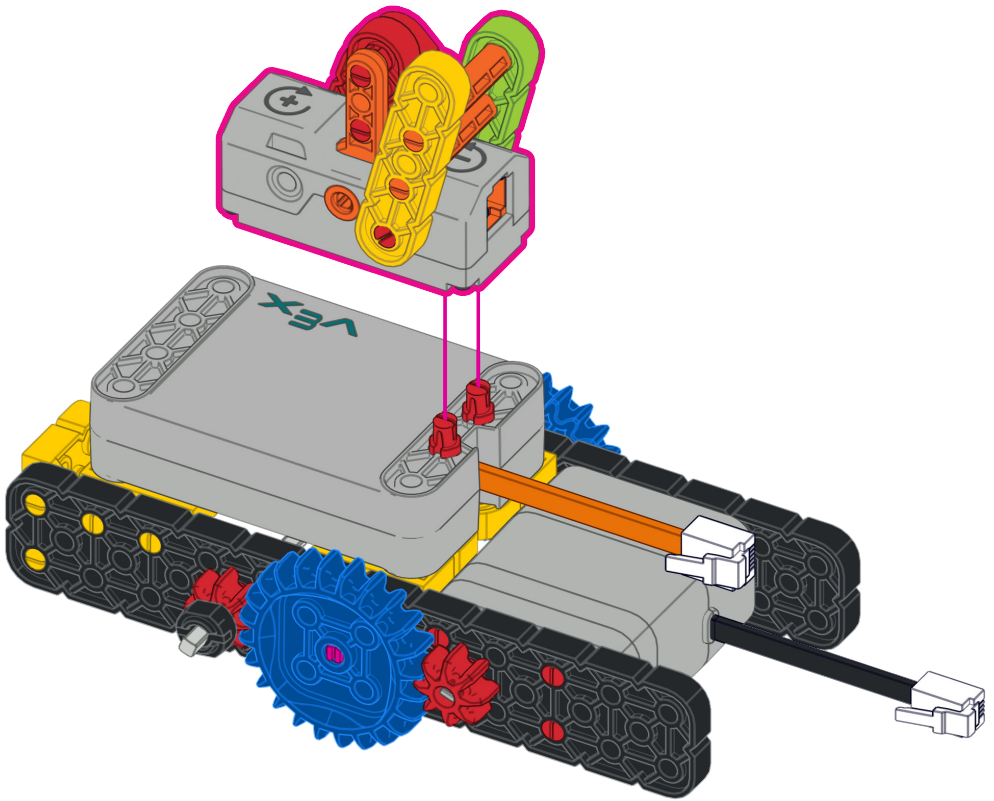

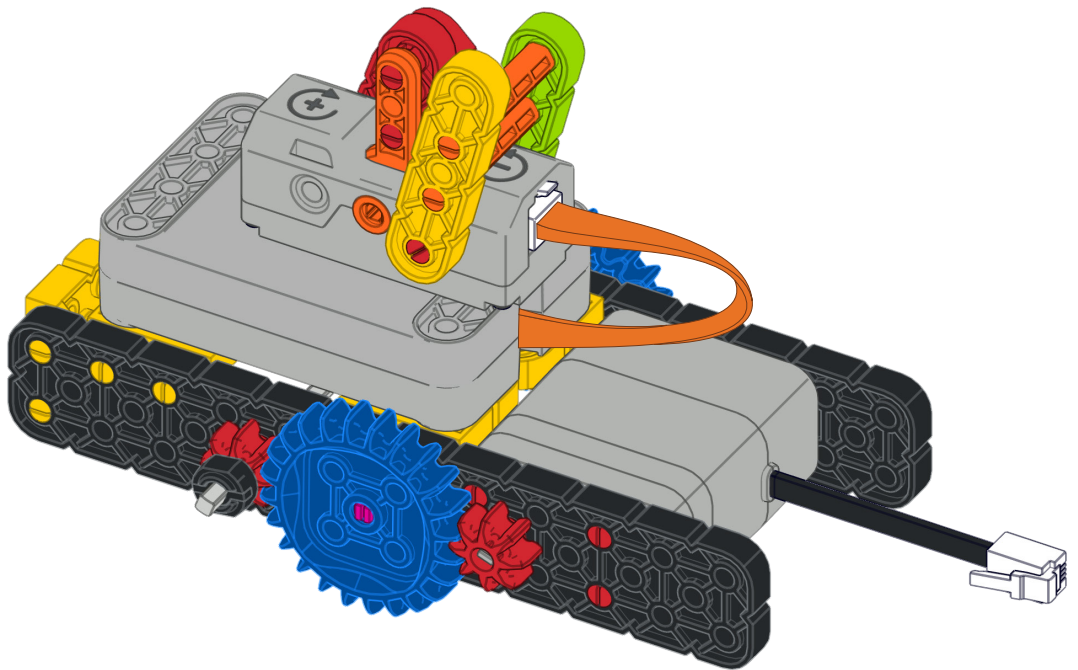
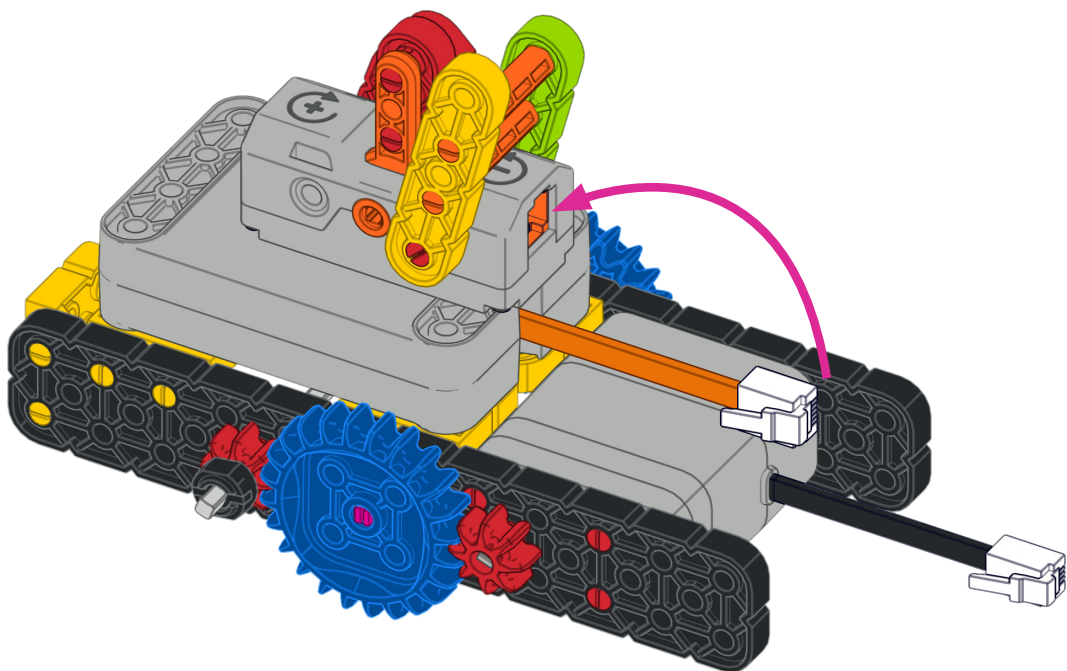

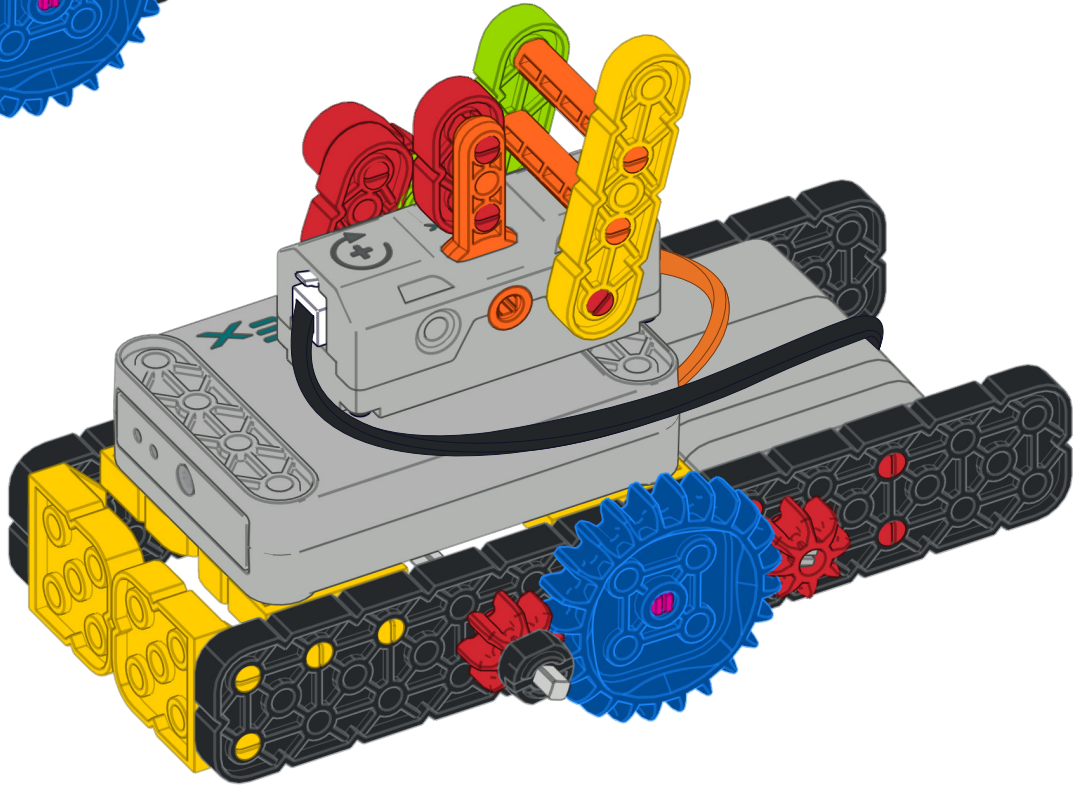
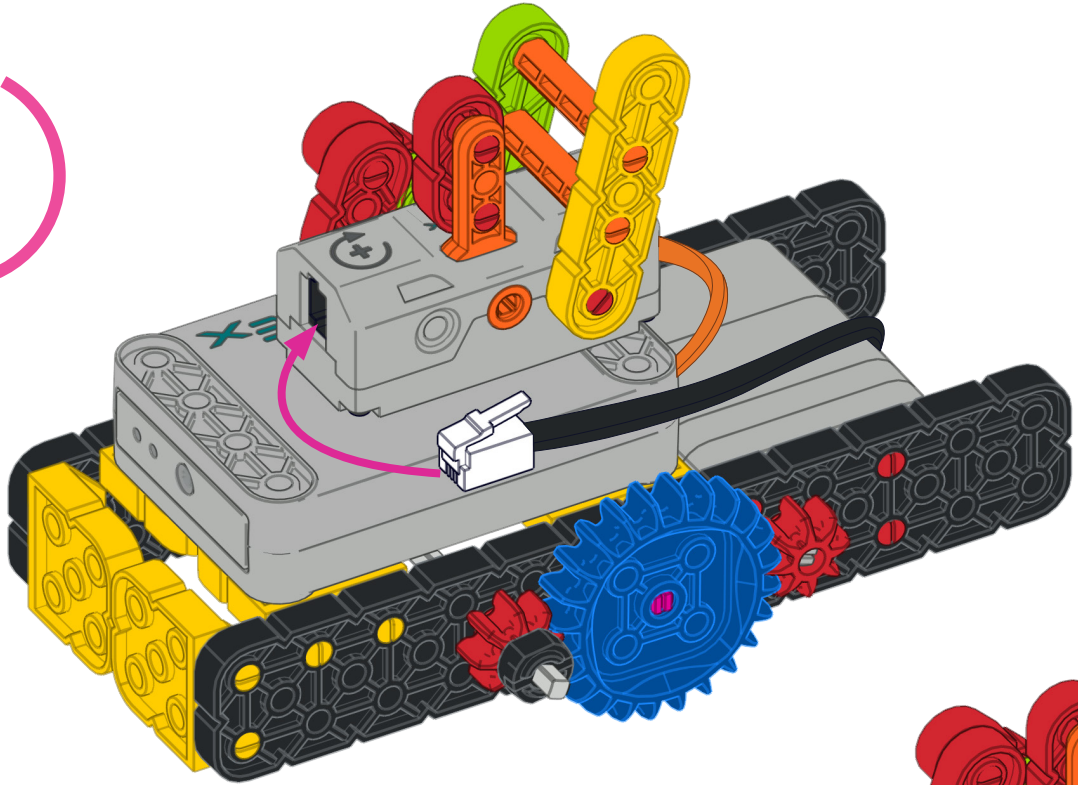
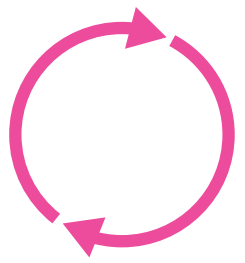

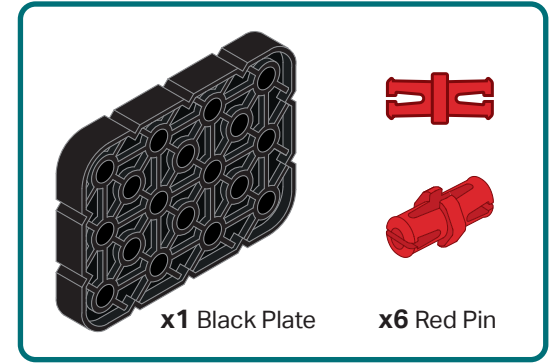
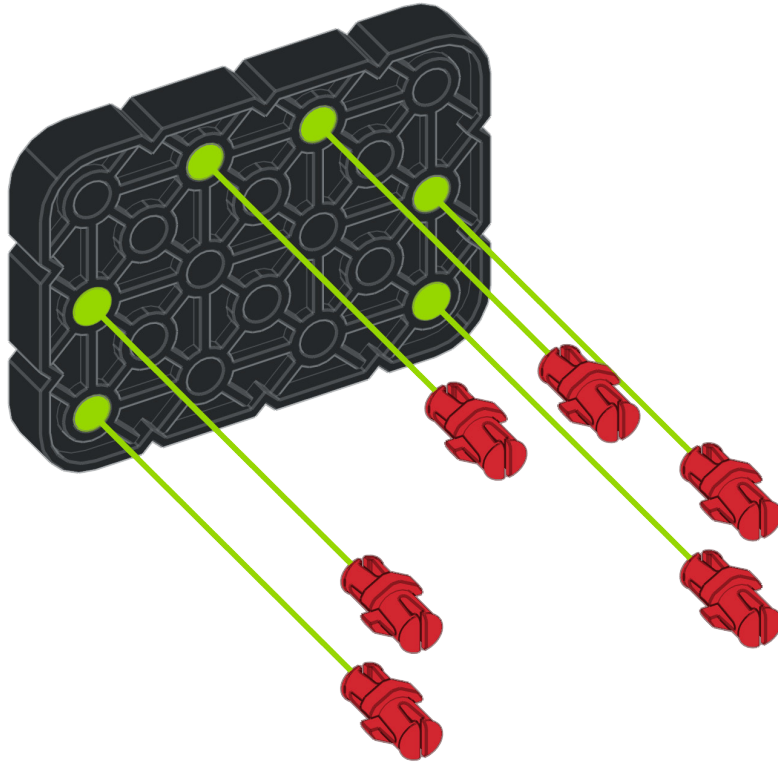

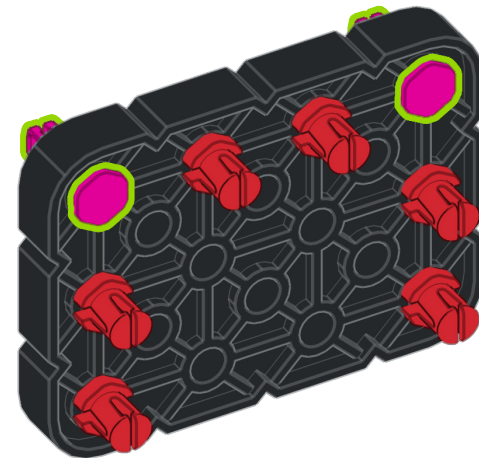
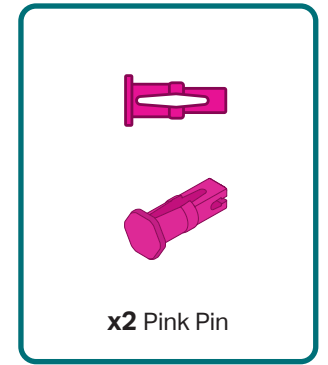
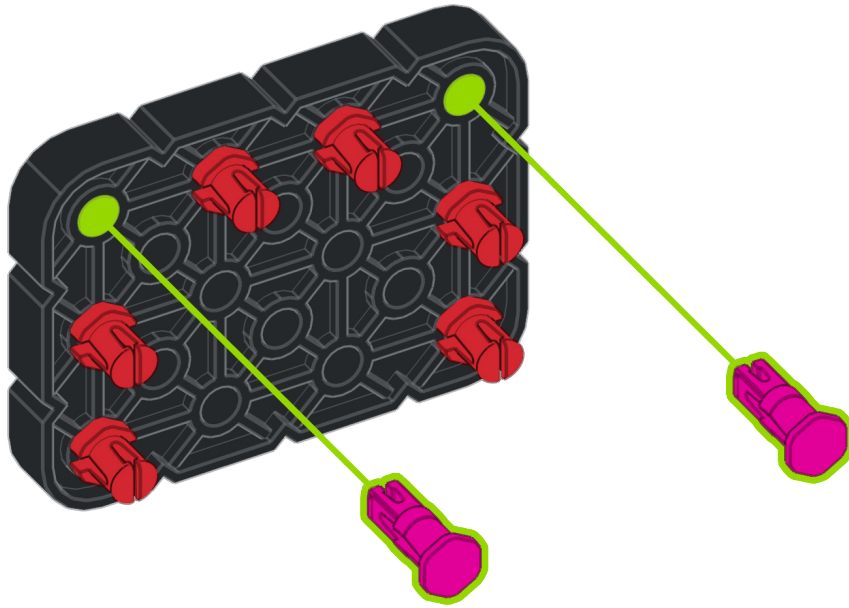

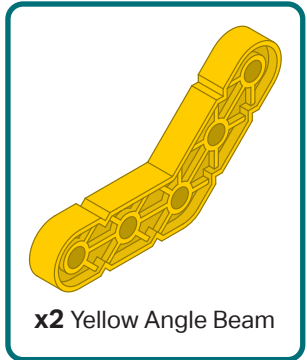
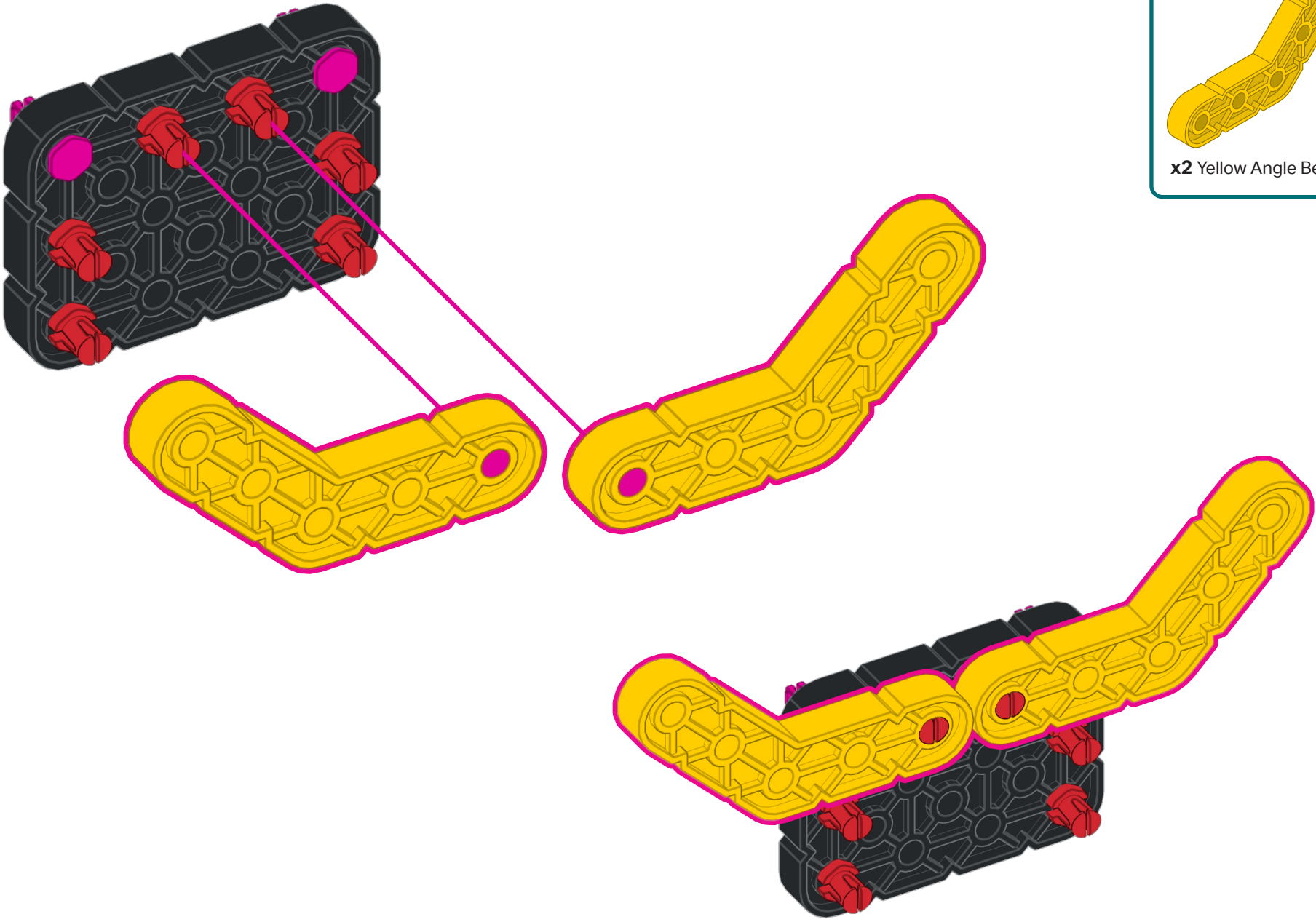

x2 Yellow Angle Beam

31

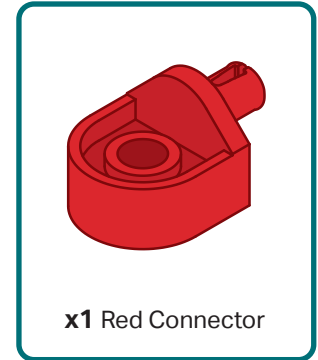
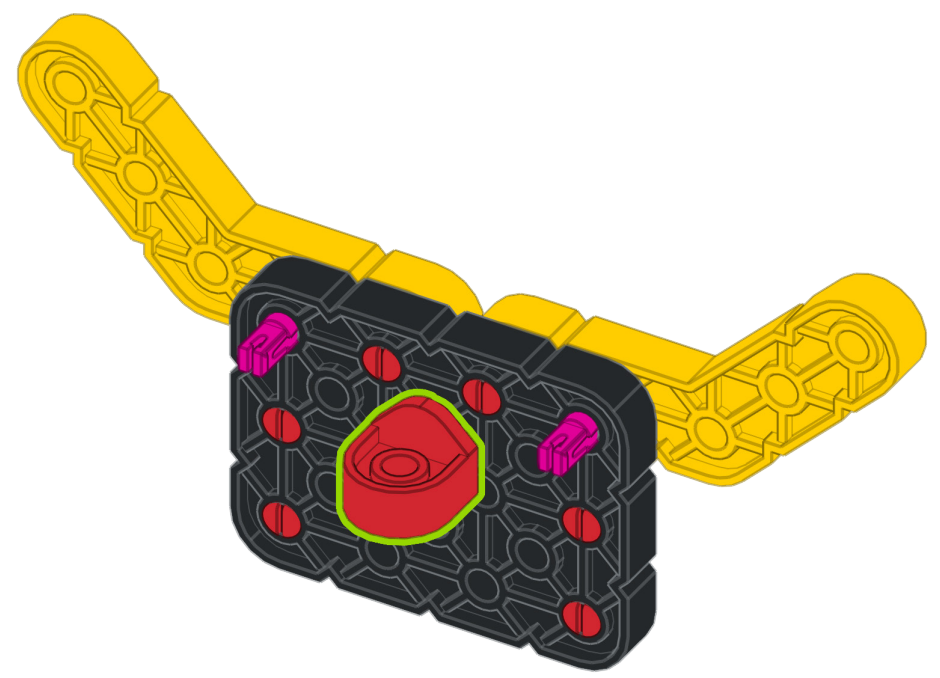
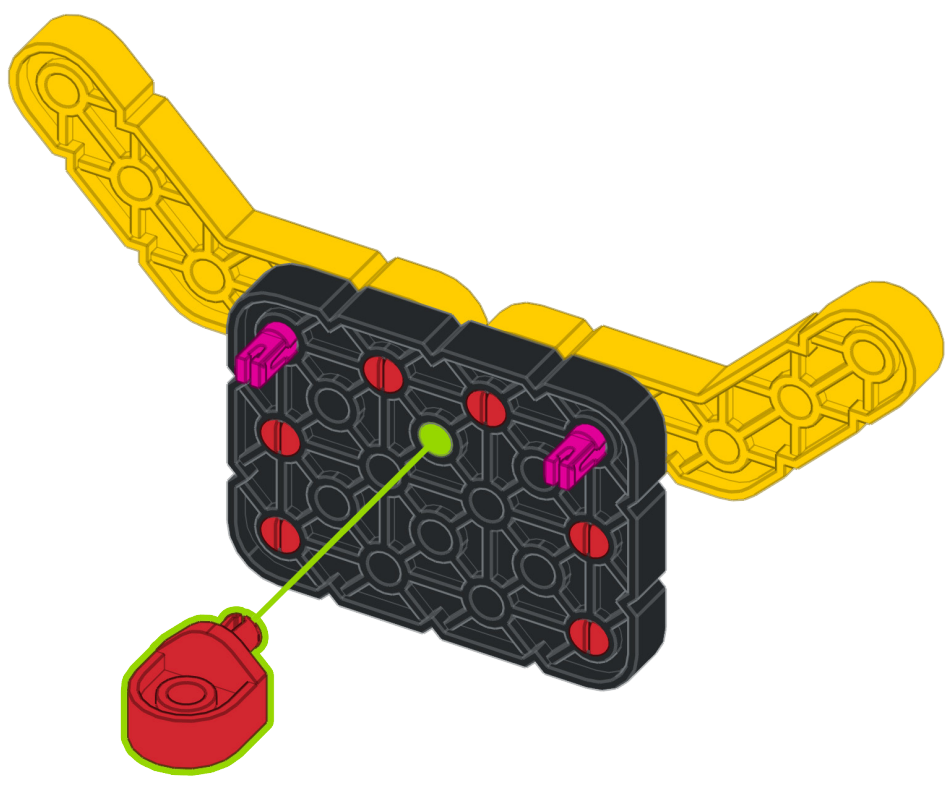
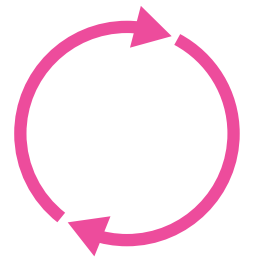

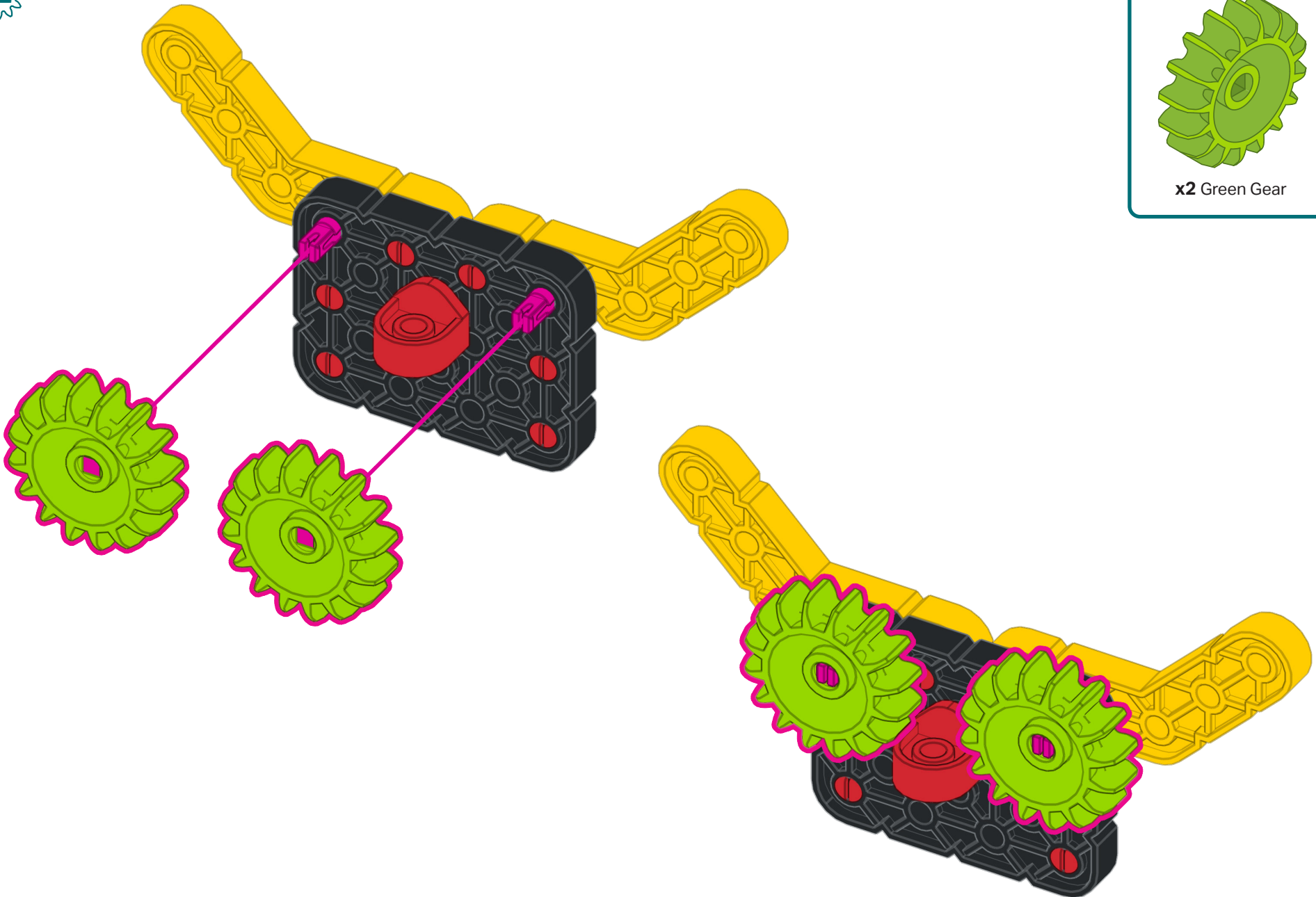

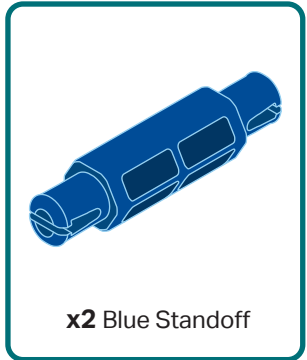
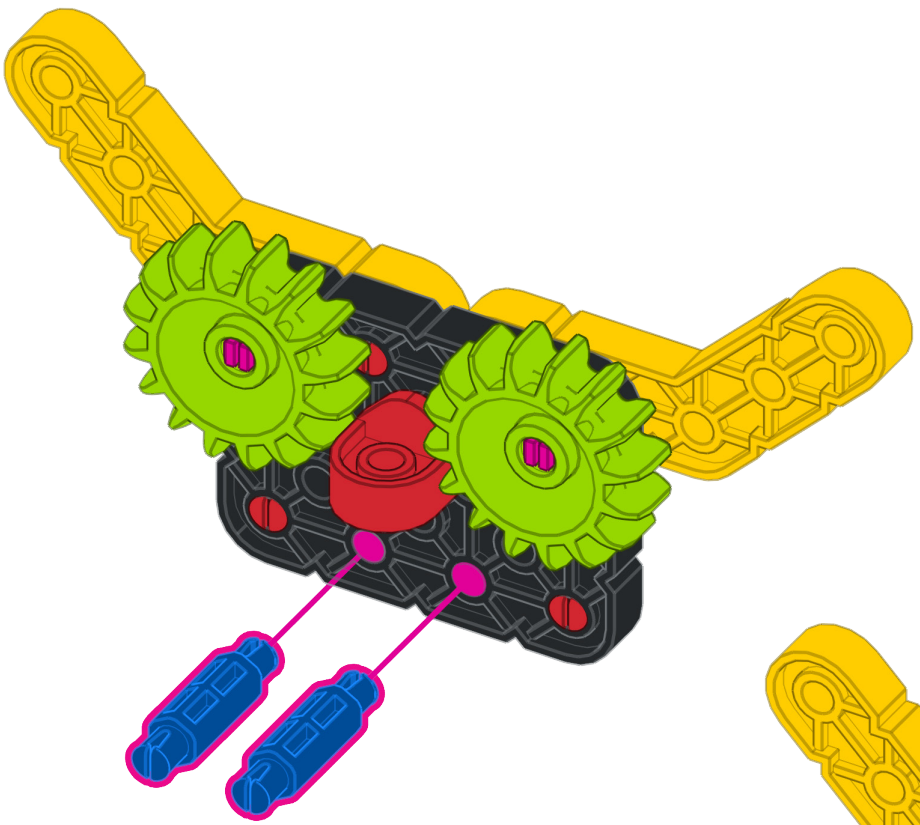

x2 Blue Standoff

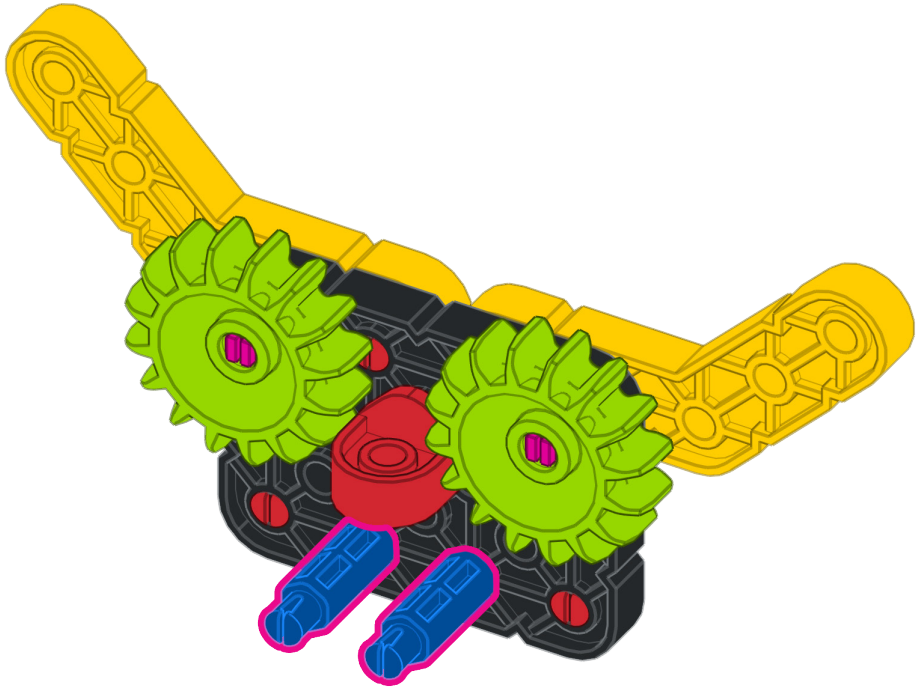

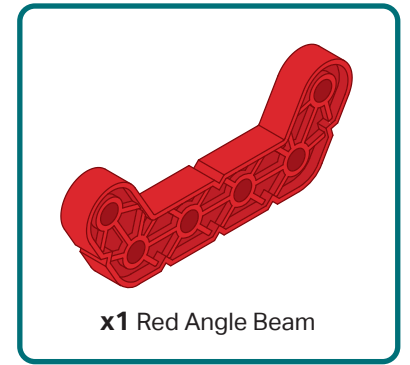
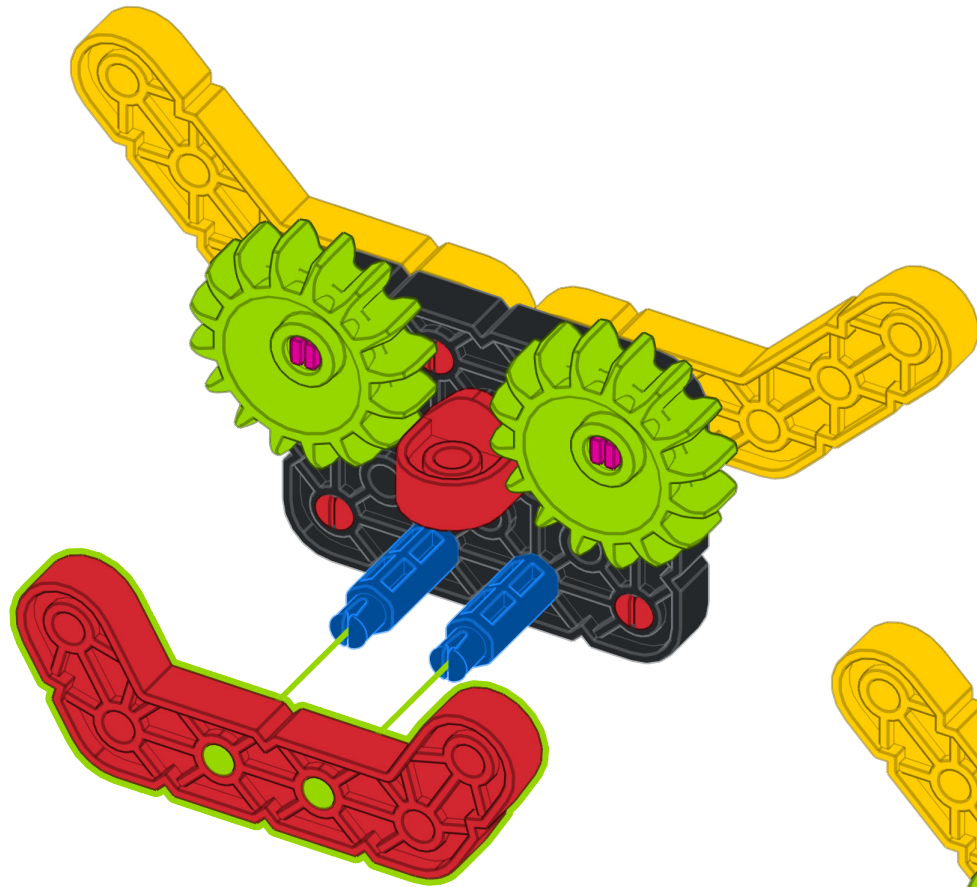

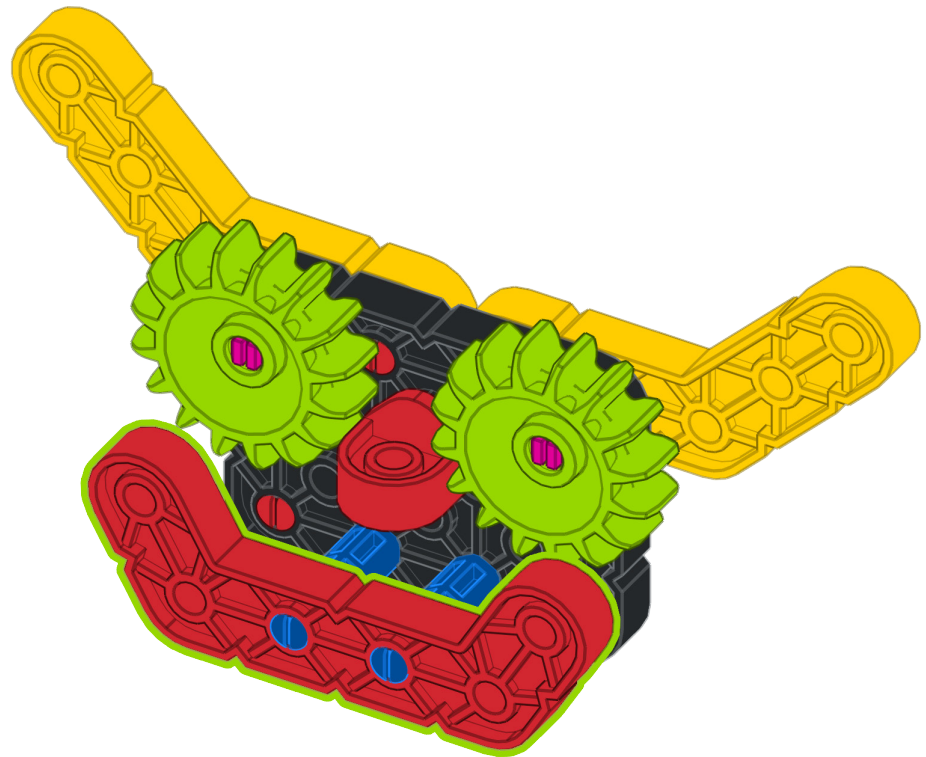

x1 Red Angle Beam

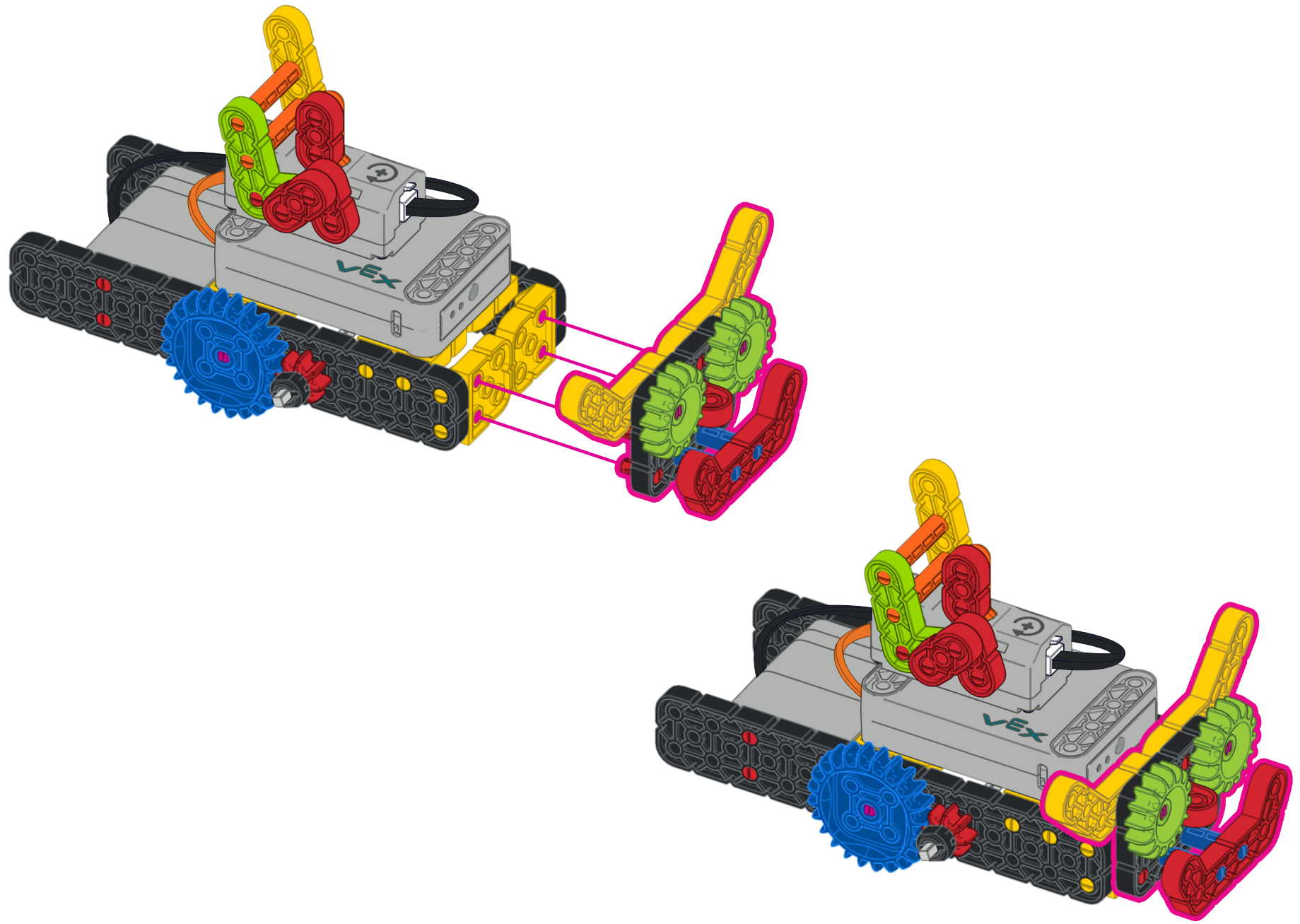

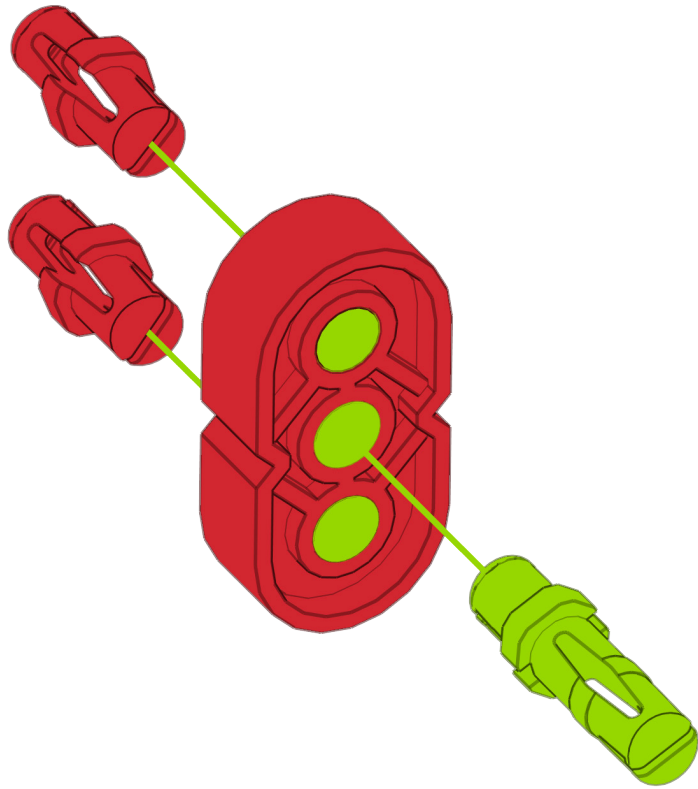

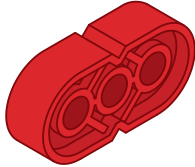

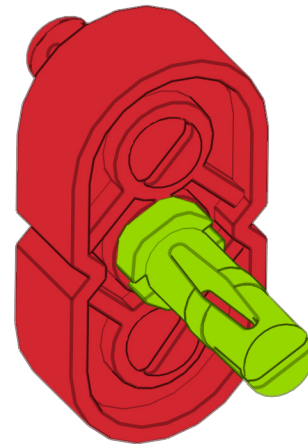

		
<b>x1 Red Beam</b>	<b>x1 Green Pin</b>	<b>x2 Red Pin</b>

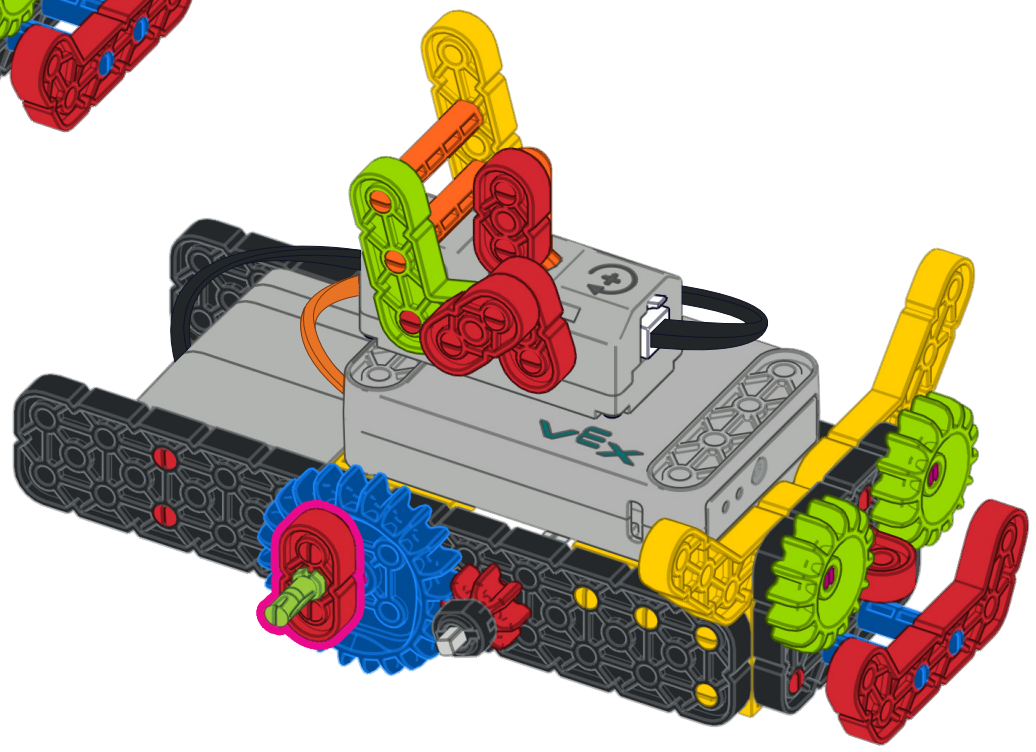
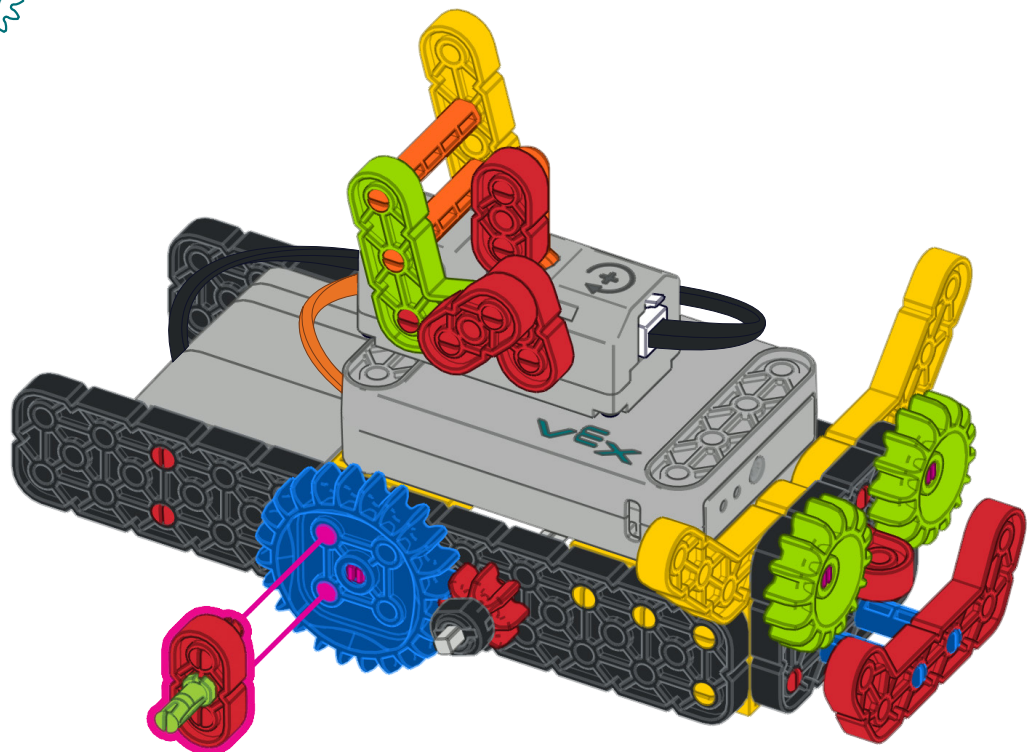

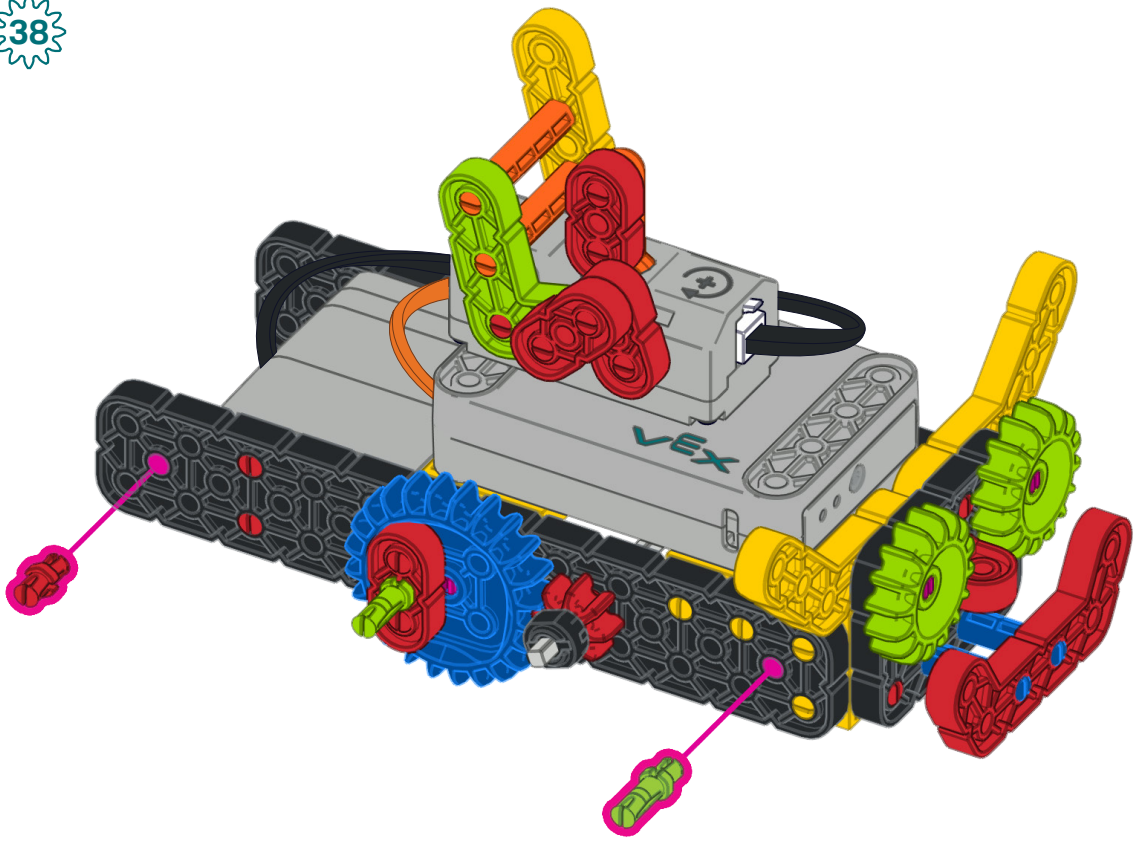

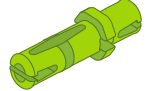
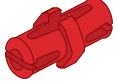

	
	
<b>x1 Green Pin</b>	<b>x1 Red Pin</b>

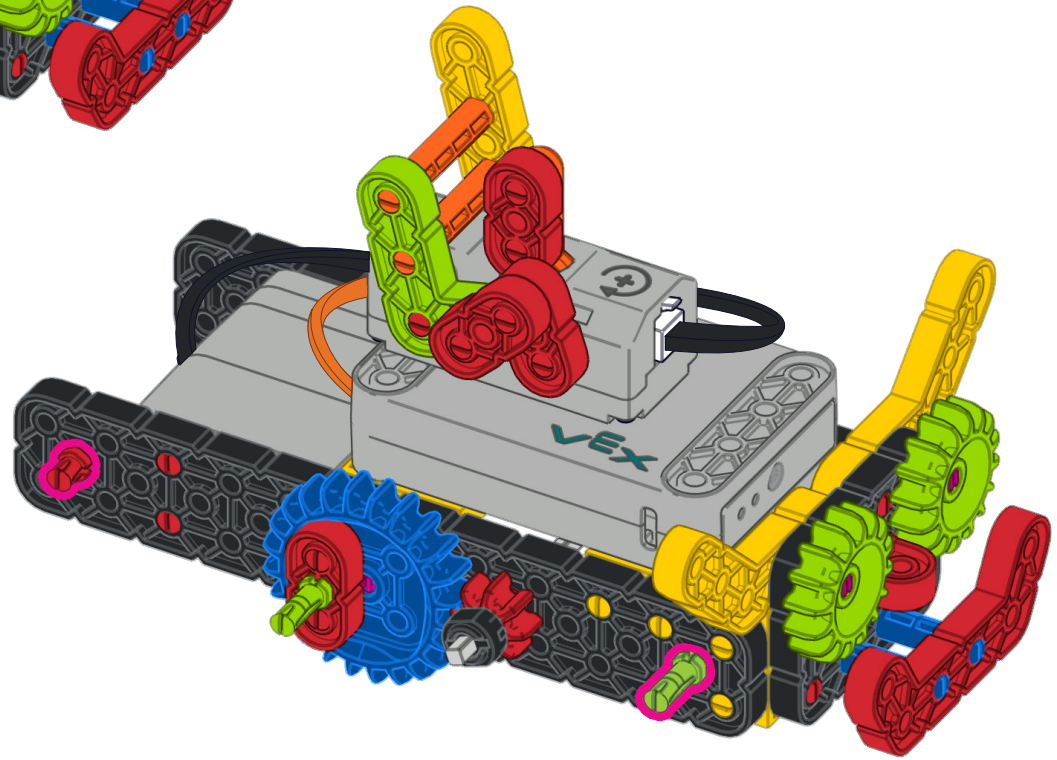

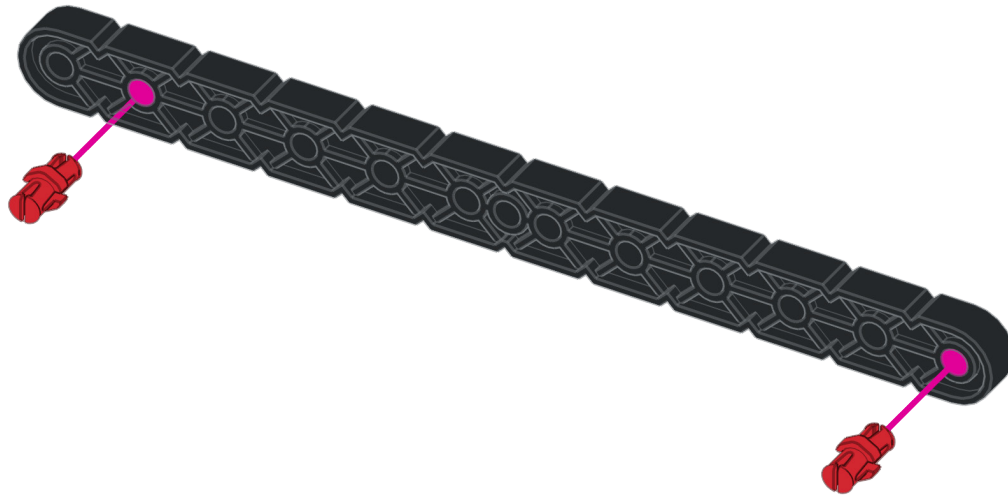

x1 Black Beam



x2 Red Pin

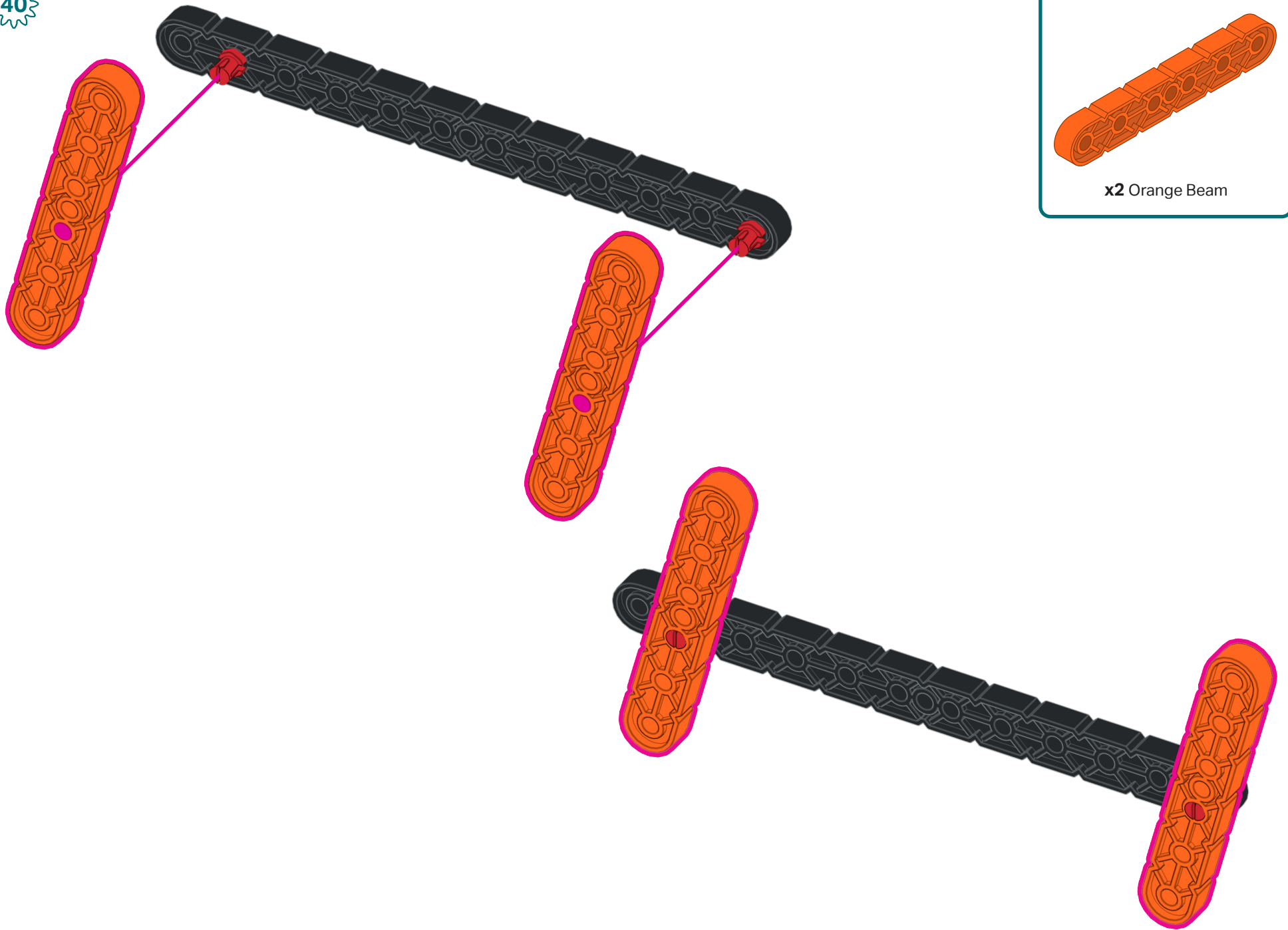

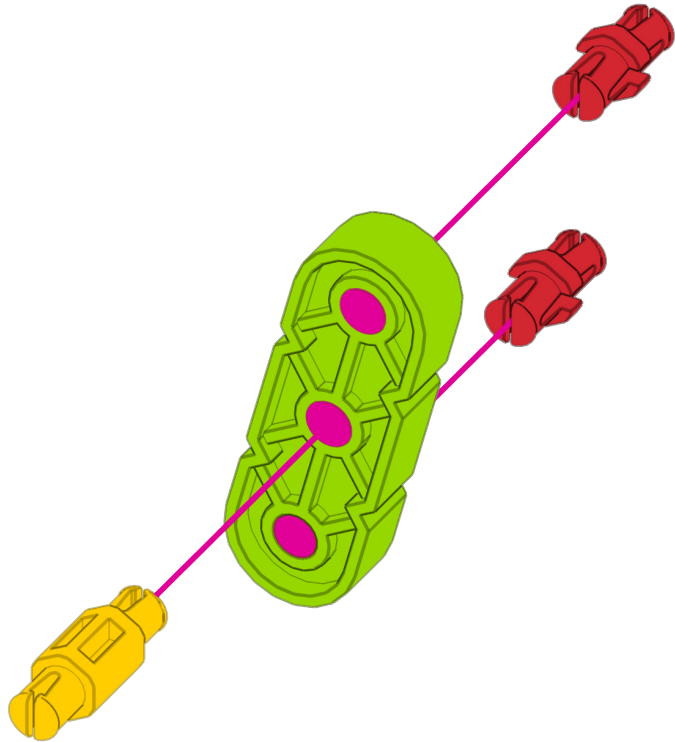

x2 Orange Beam

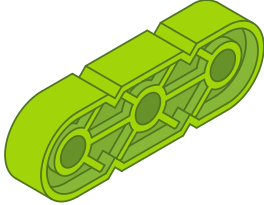
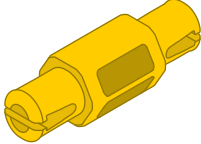

		
<b>x1 Green Beam</b>	<b>x1 Yellow Standoff</b>	<b>x2 Red Pin</b>

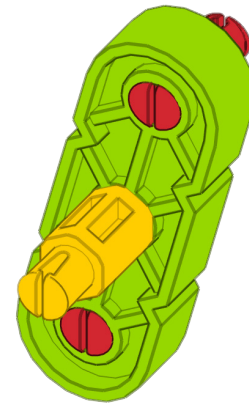

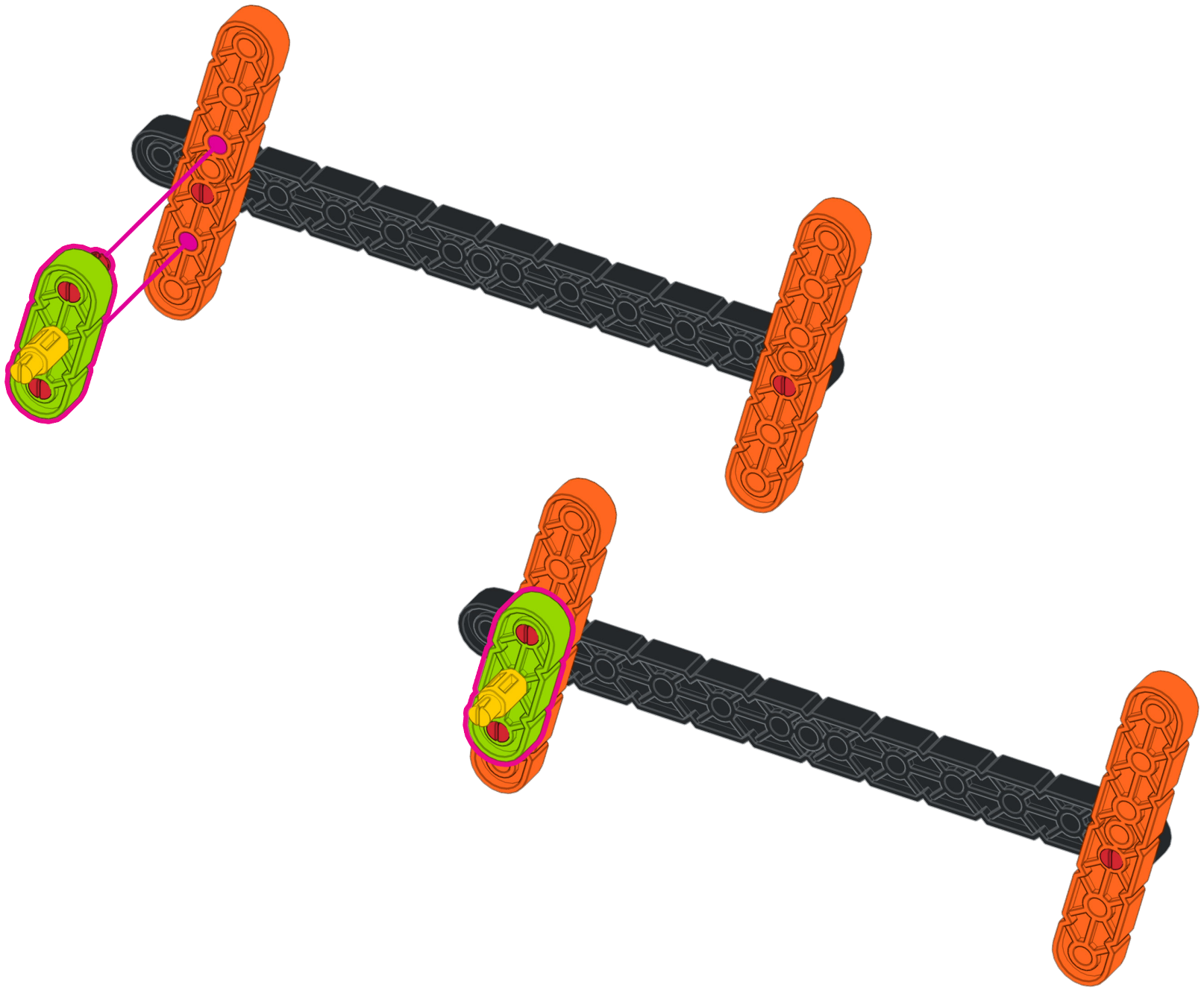

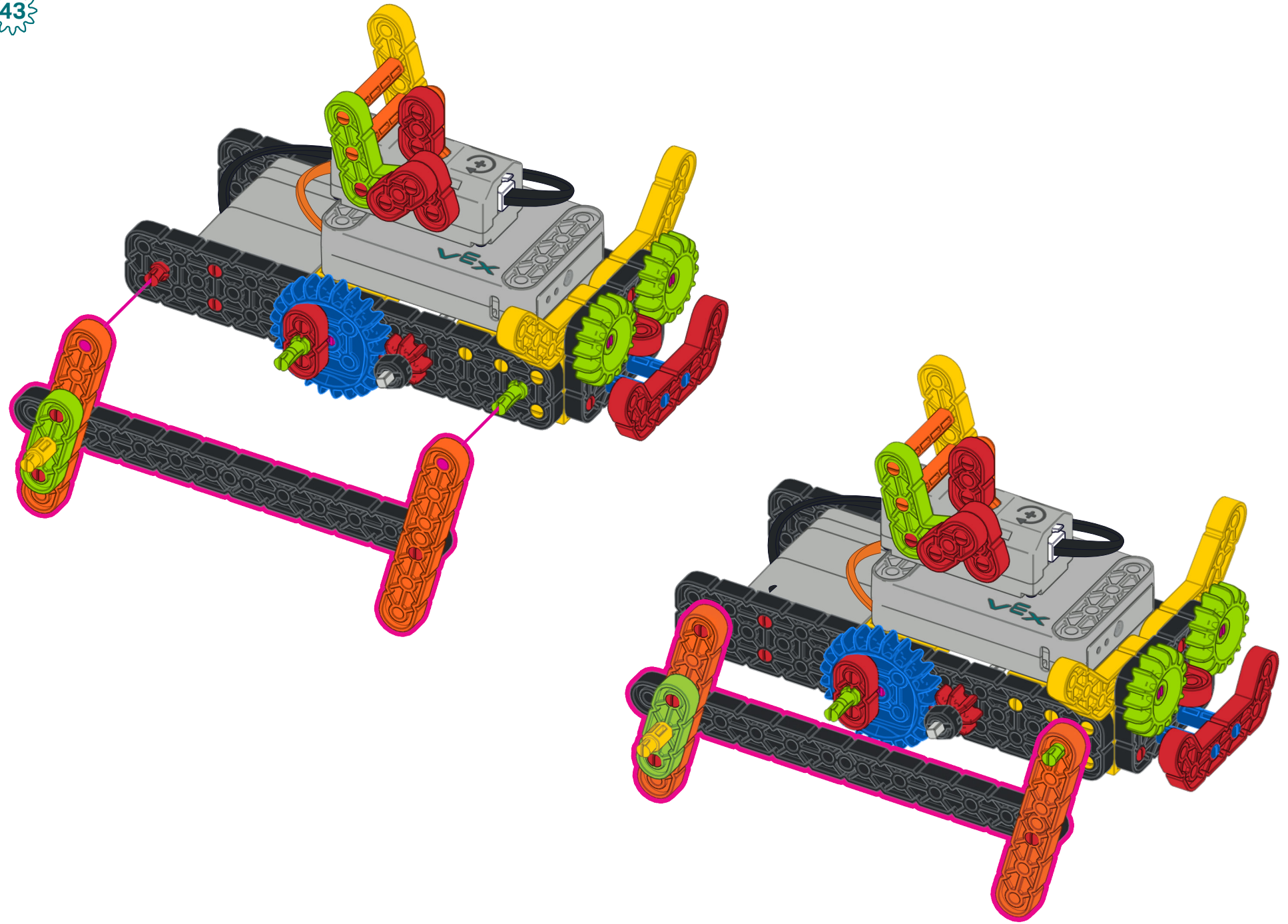

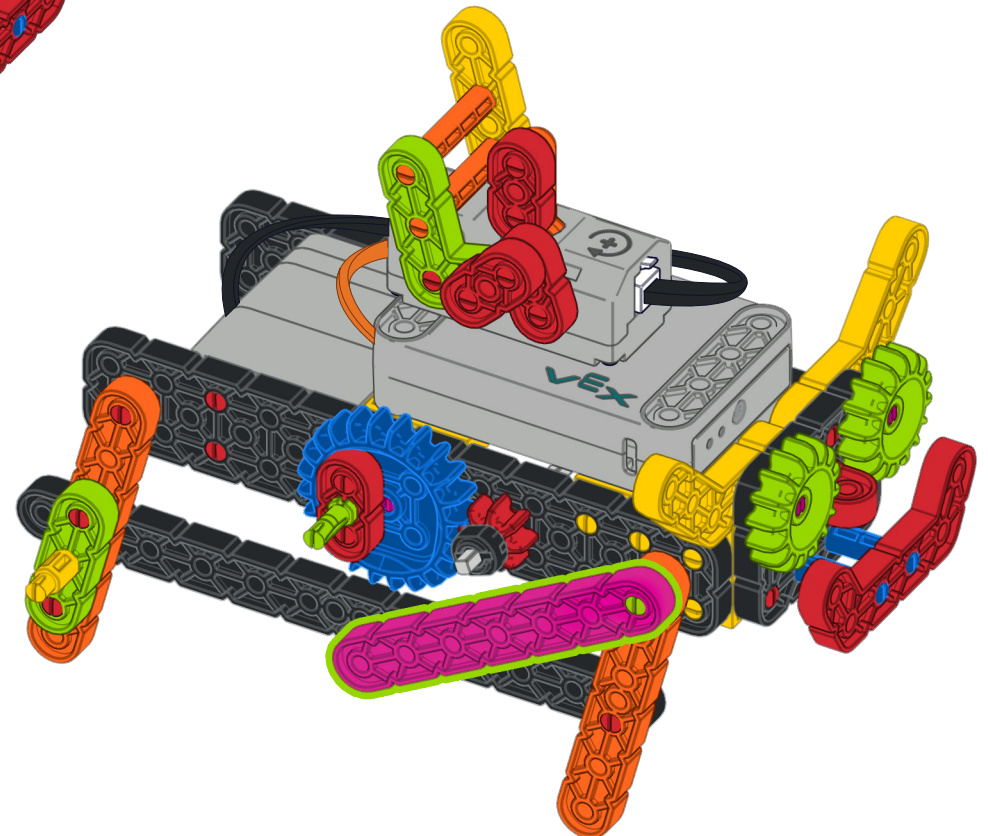
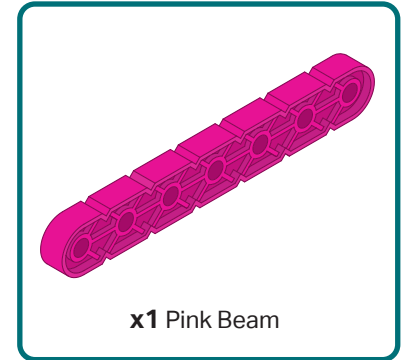
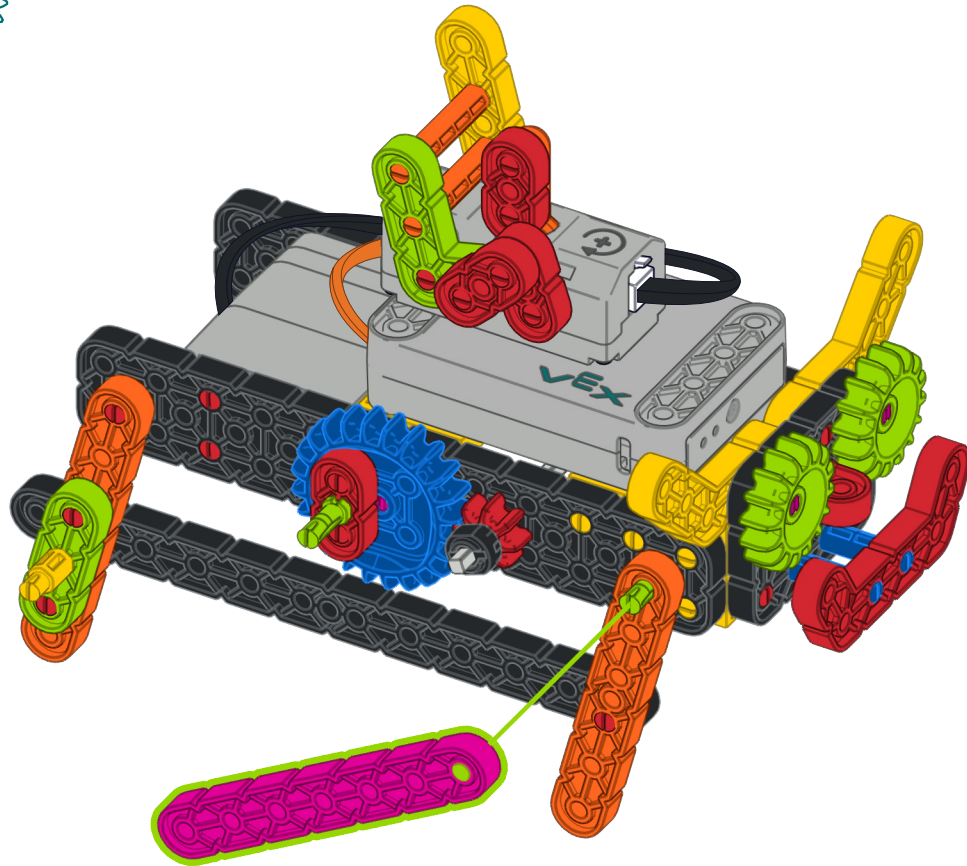

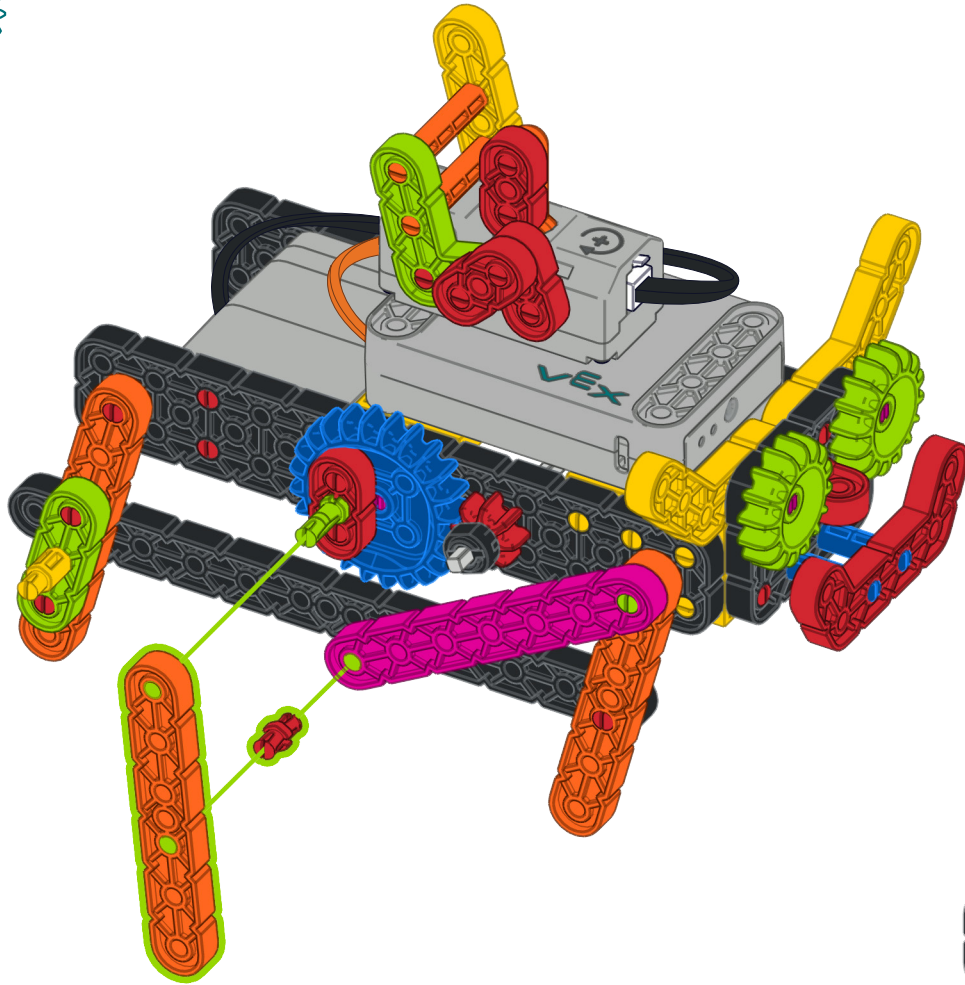

x1 Orange Beam

x1 Red Pin

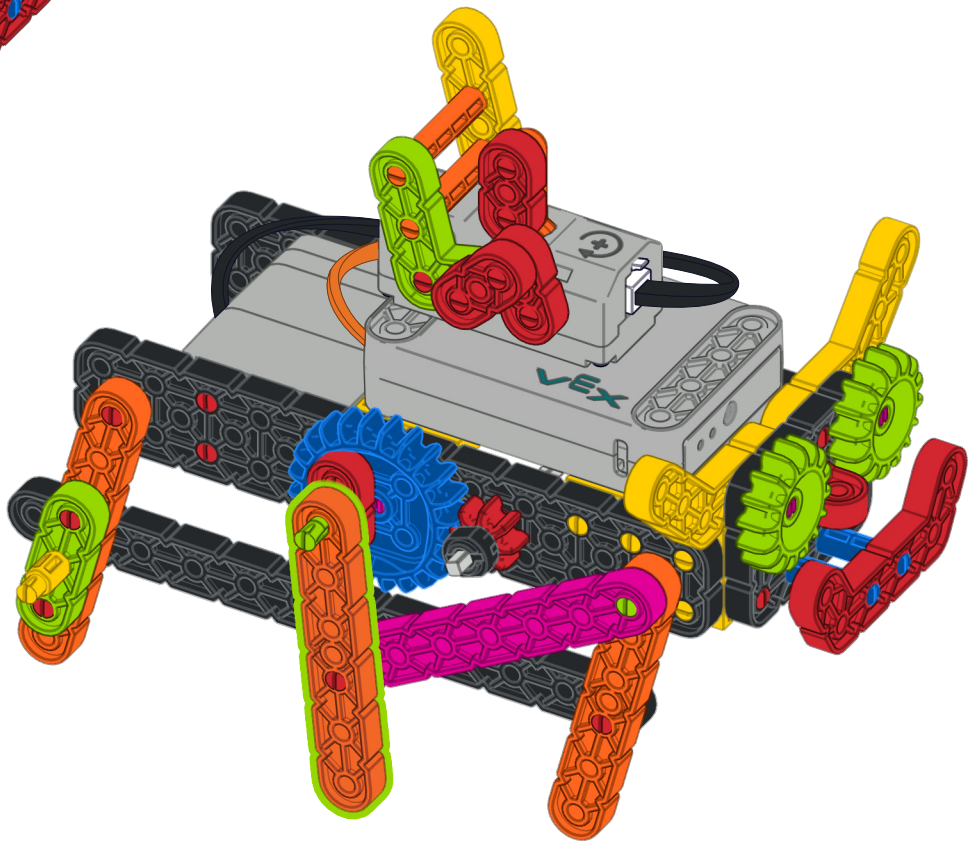

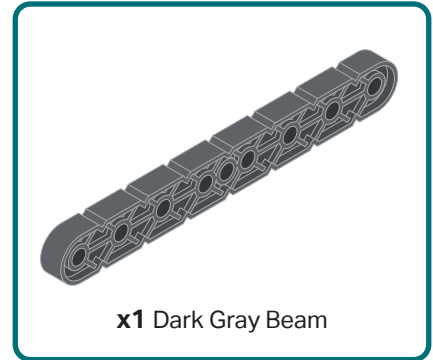
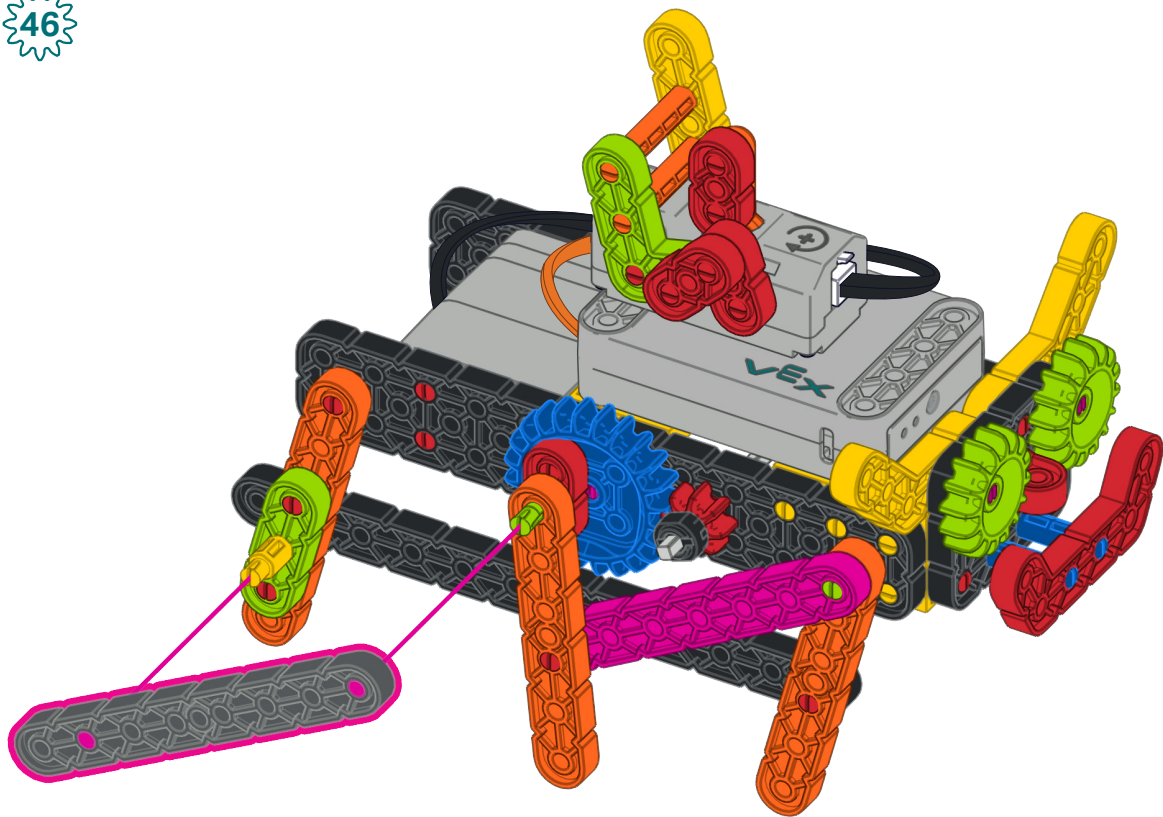

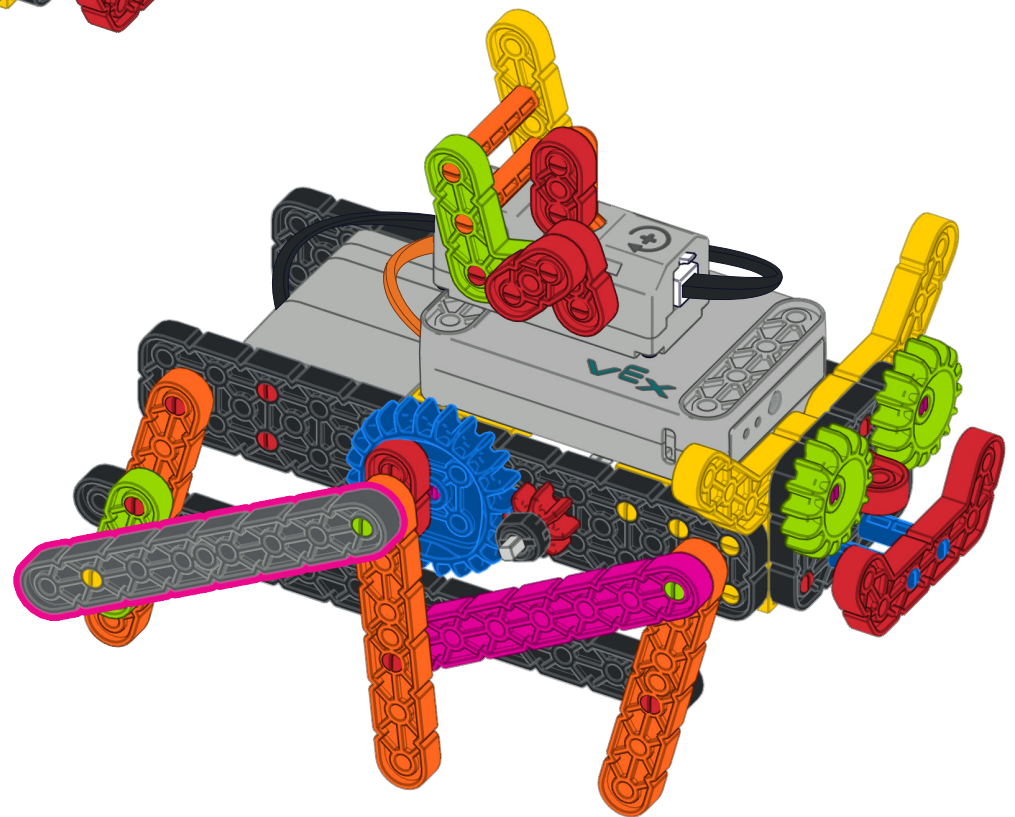

x1 Dark Gray Beam

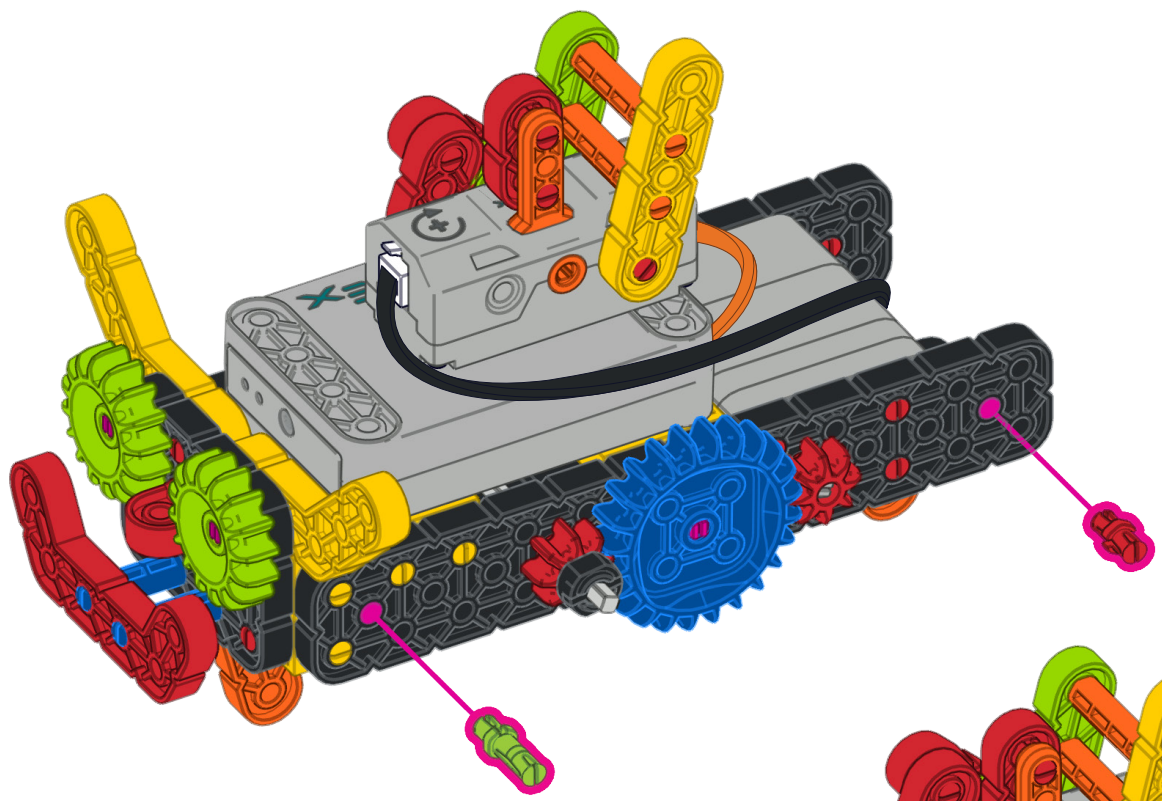
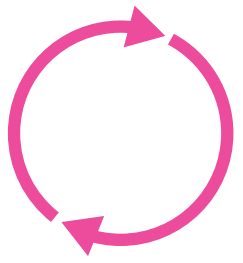



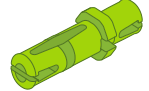
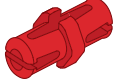

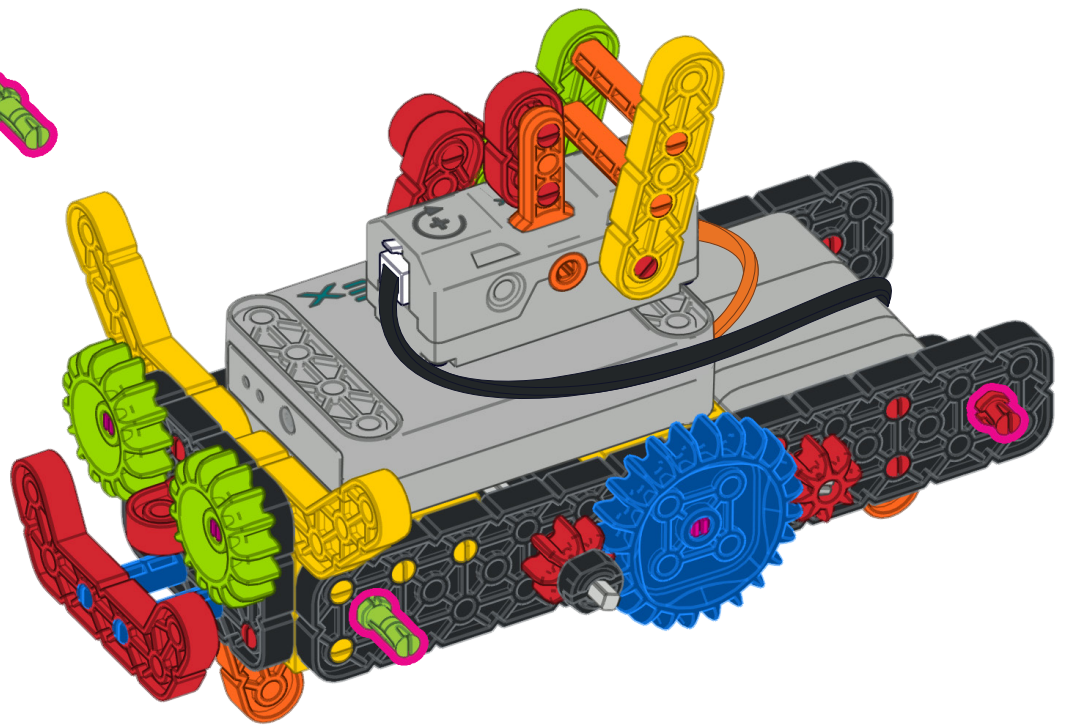
	
	
<b>x1 Green Pin</b>	<b>x1 Red Pin</b>

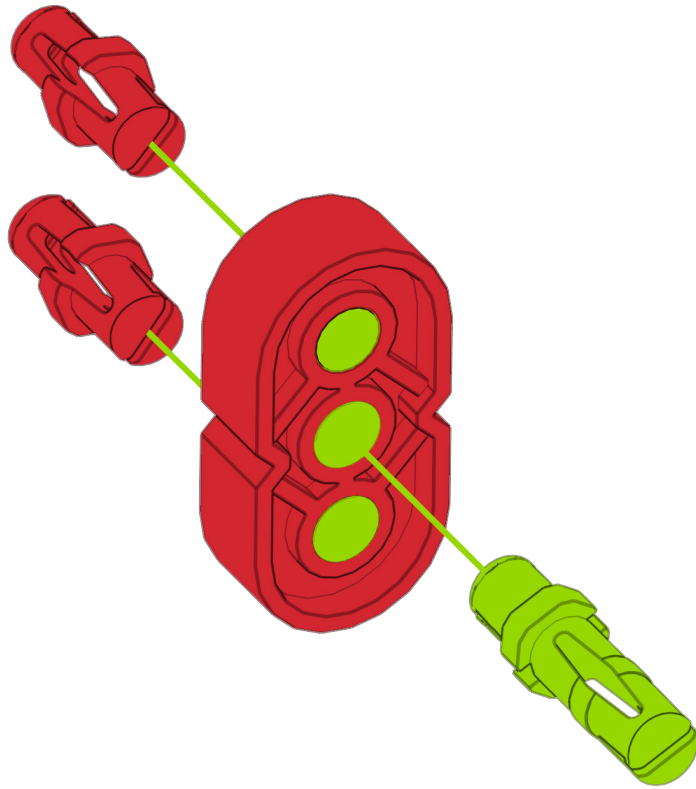

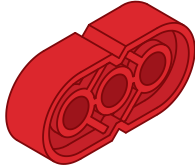

		
<b>x1 Red Beam</b>	<b>x1 Green Pin</b>	<b>x2 Red Pin</b>

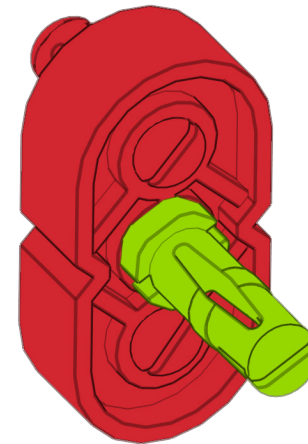

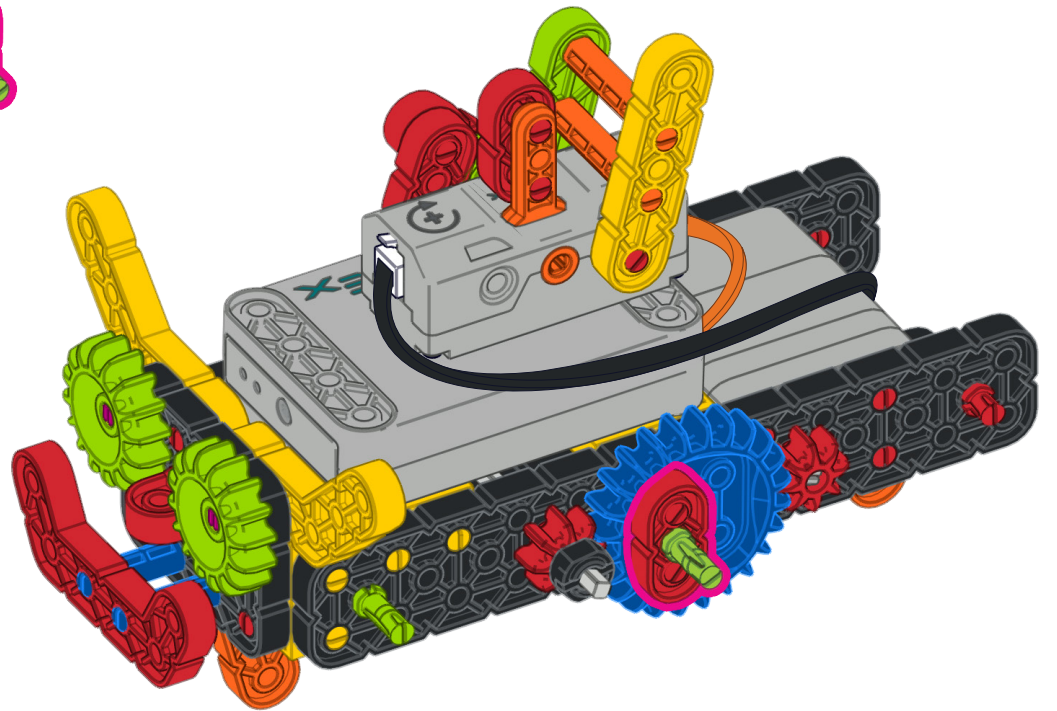
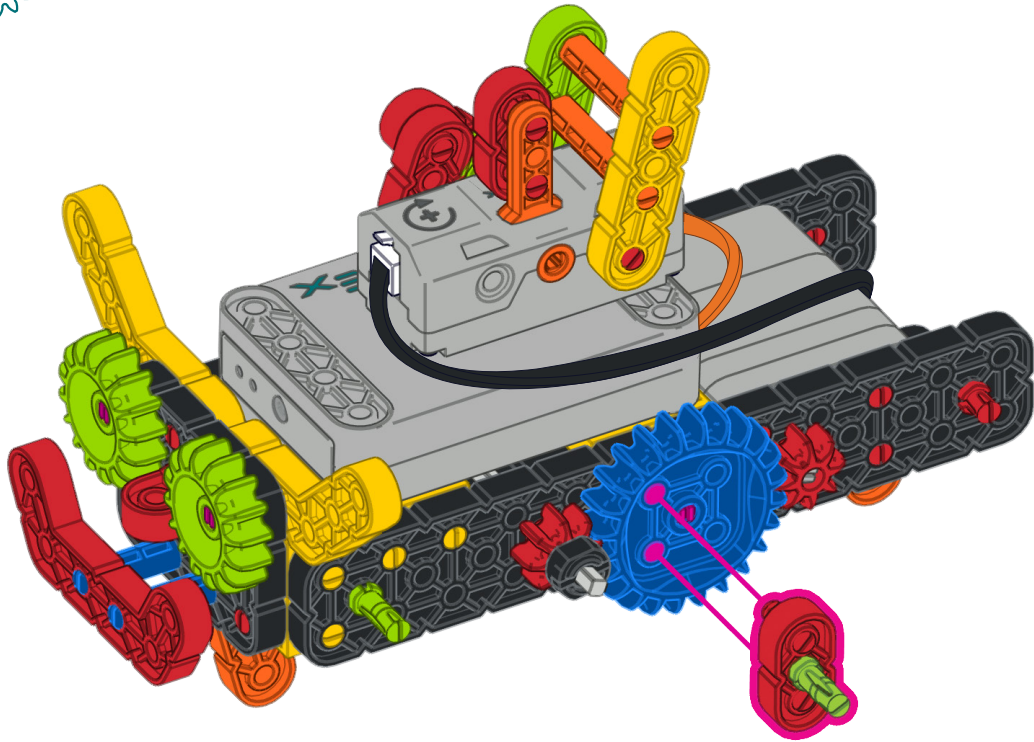

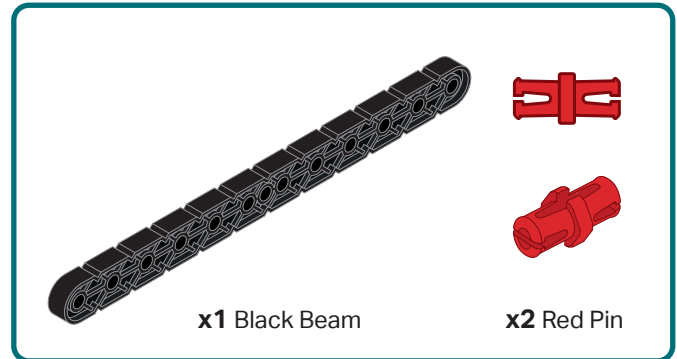

x1 Black Beam

x2 Red Pin

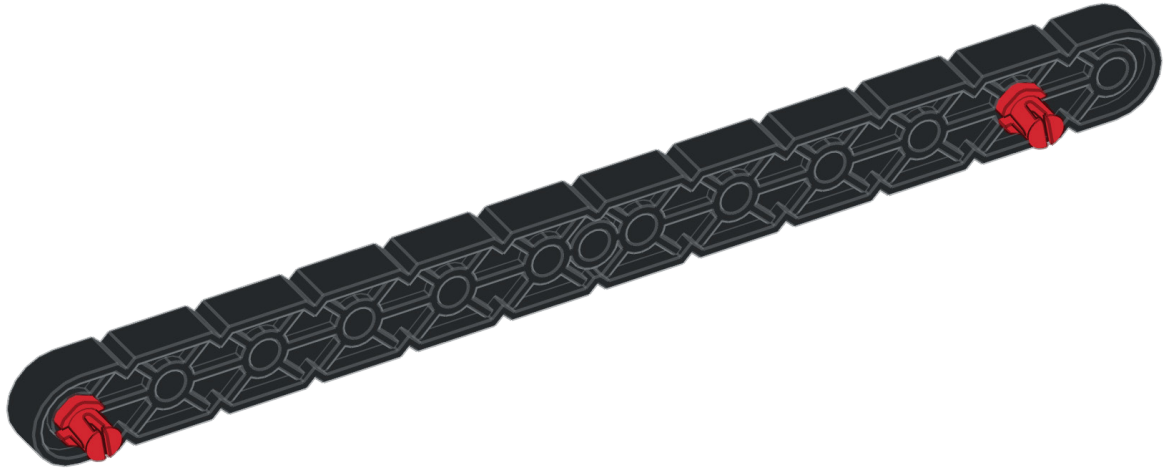
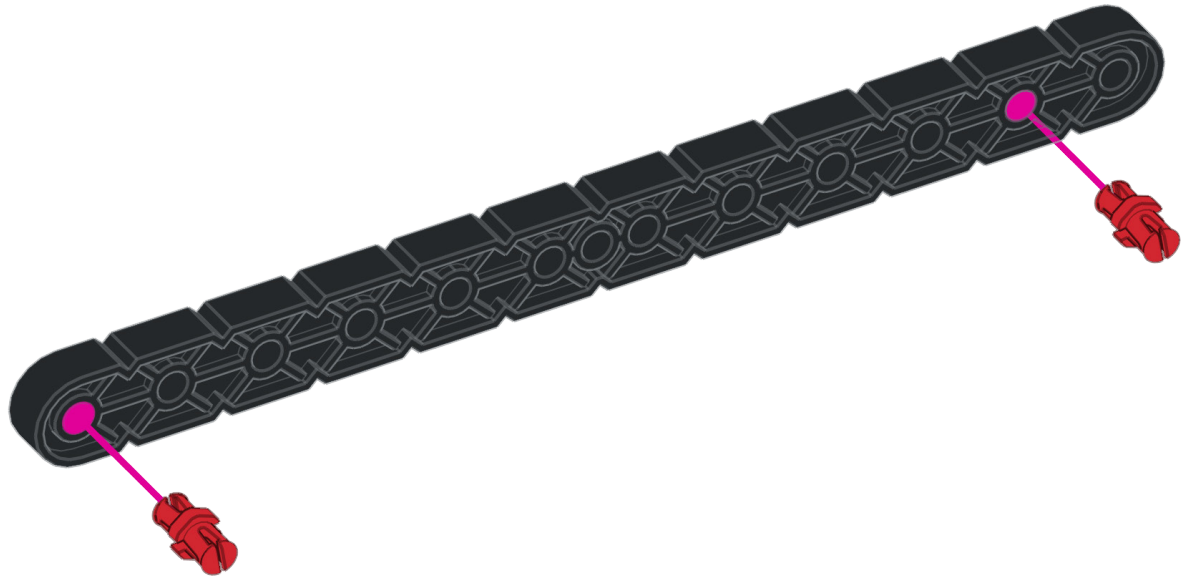

This inset box contains a black beam and two red pins. The beam is a long, dark grey/black component with a repeating geometric pattern of circles and lines. The red pins are small, cylindrical components with a flared end. The text 'x1 Black Beam' and 'x2 Red Pin' is printed below the respective items.

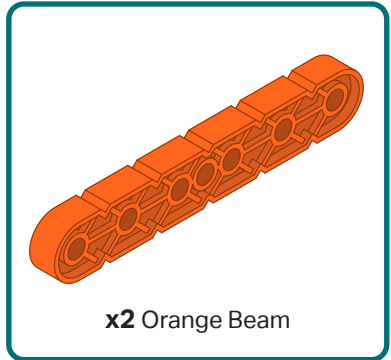
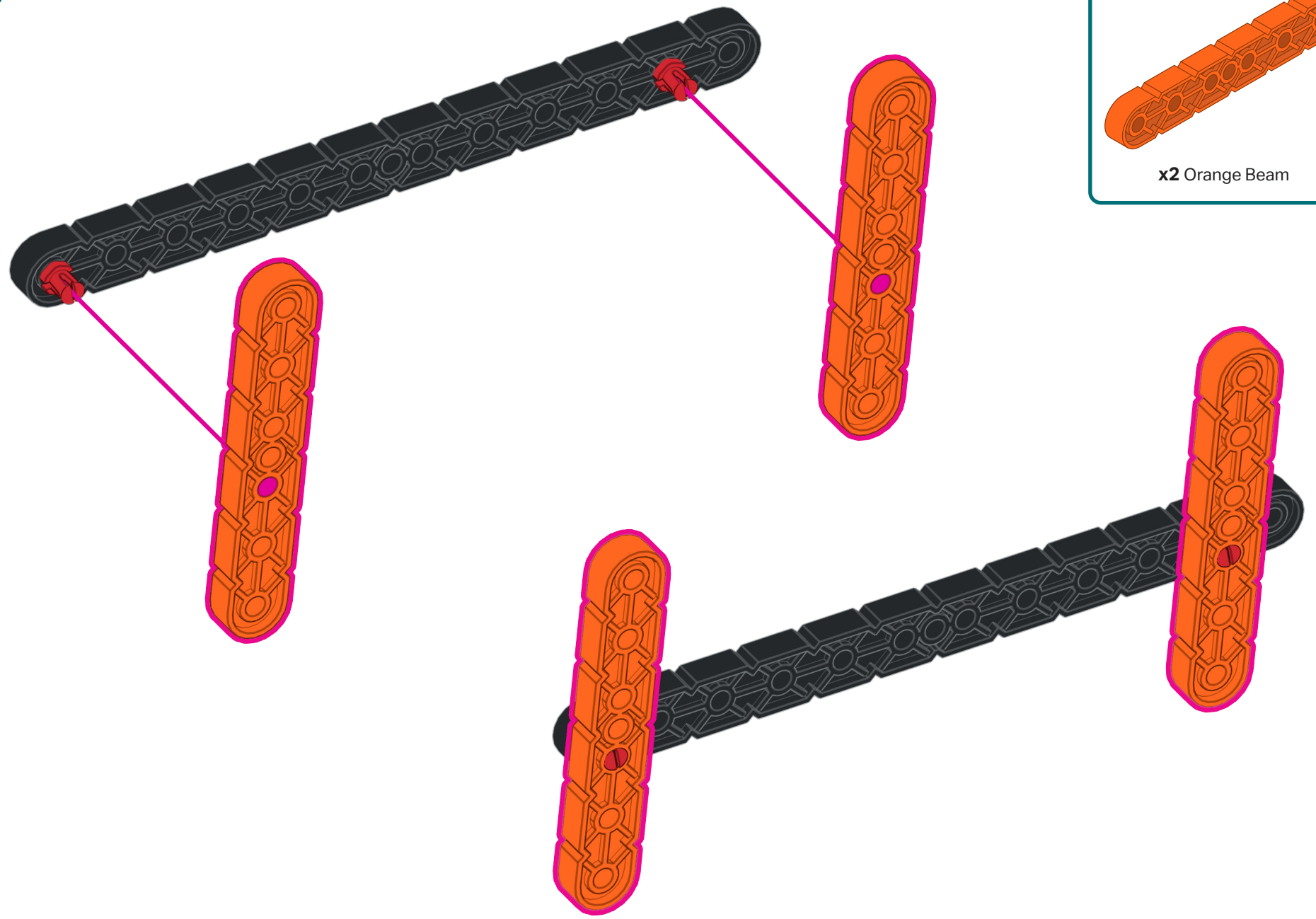

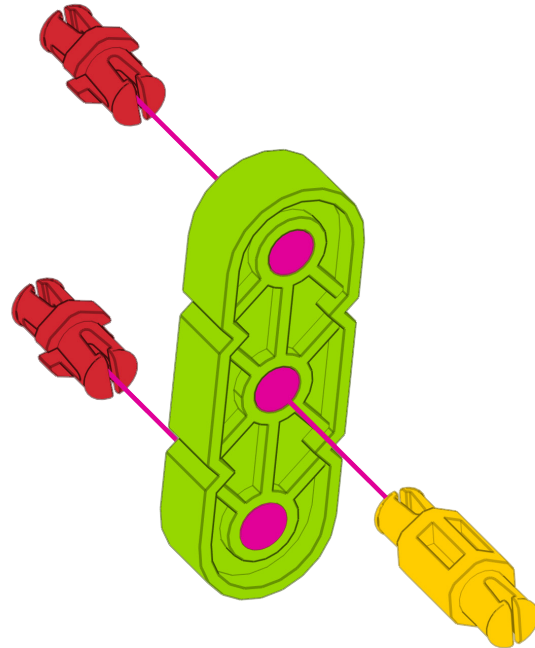

x2 Orange Beam

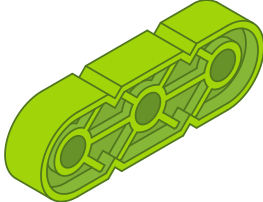
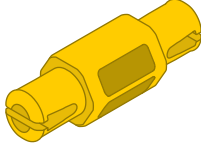

		
<b>x1 Green Beam</b>	<b>x1 Yellow Standoff</b>	<b>x2 Red Pin</b>

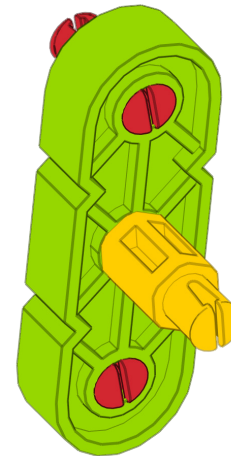

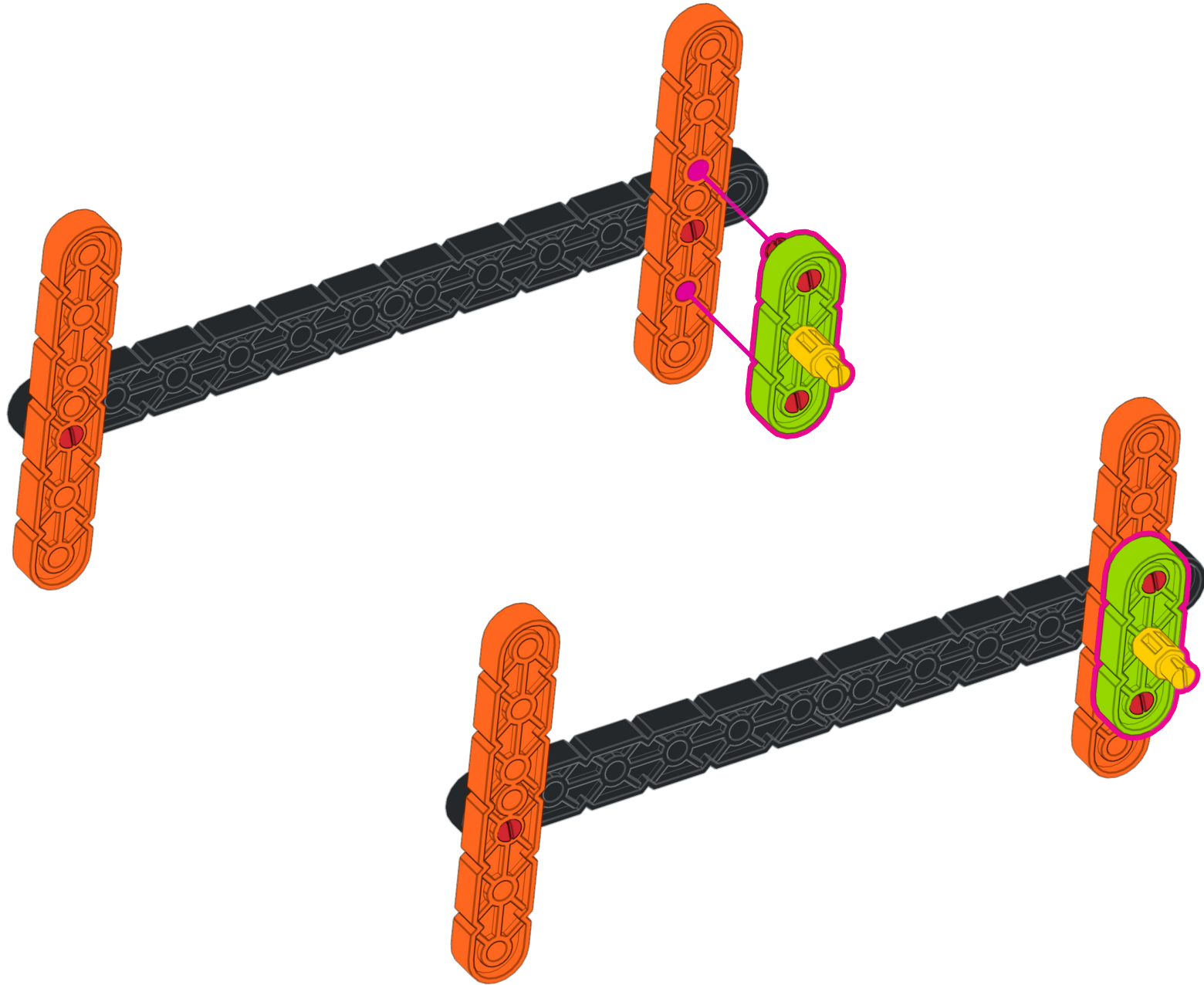

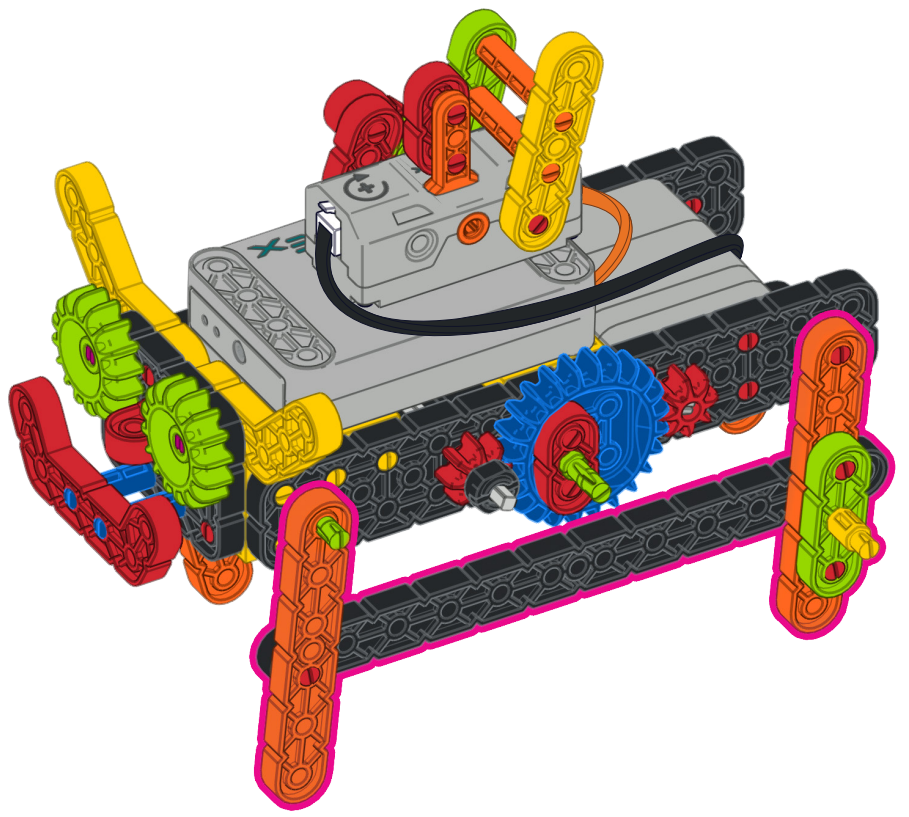
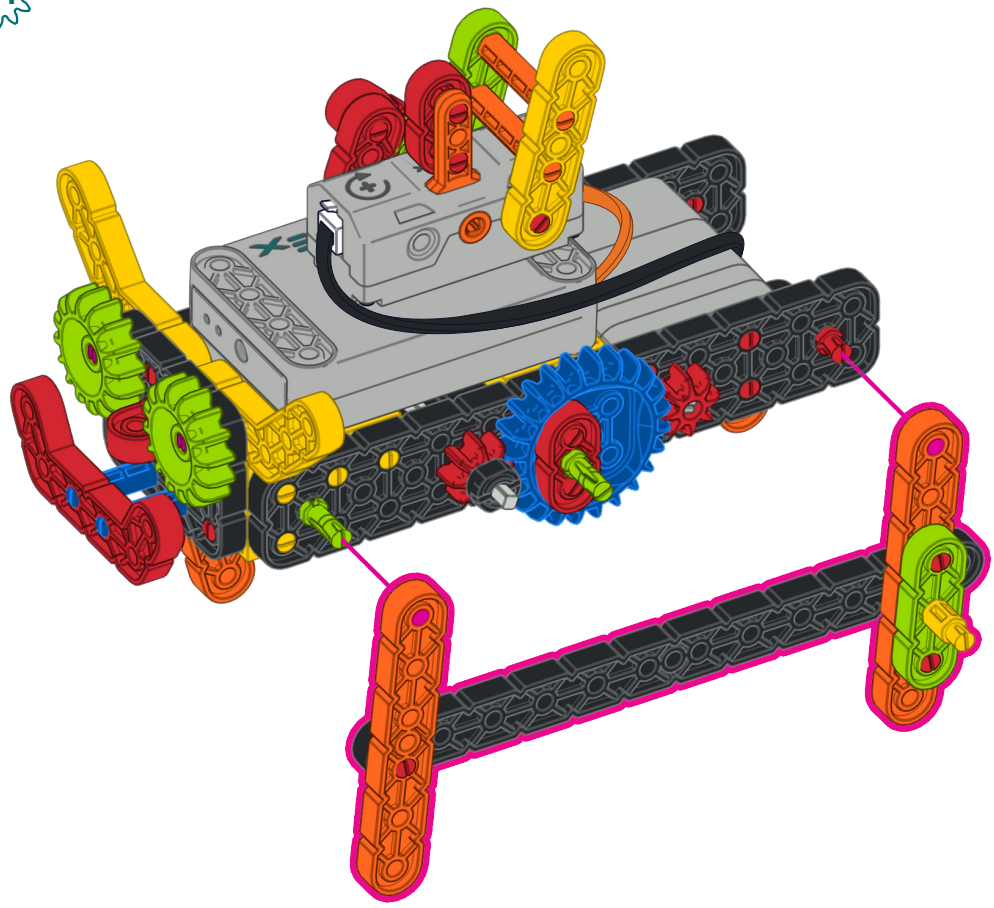

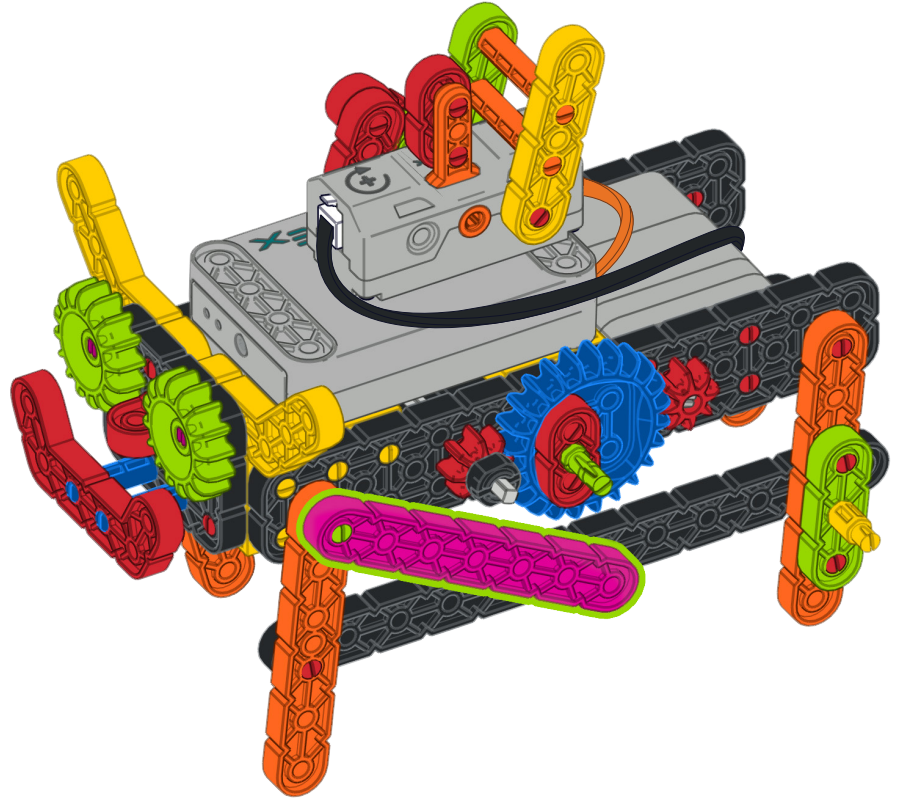
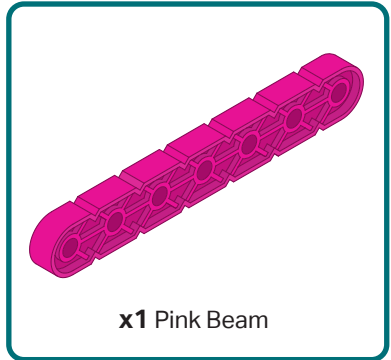
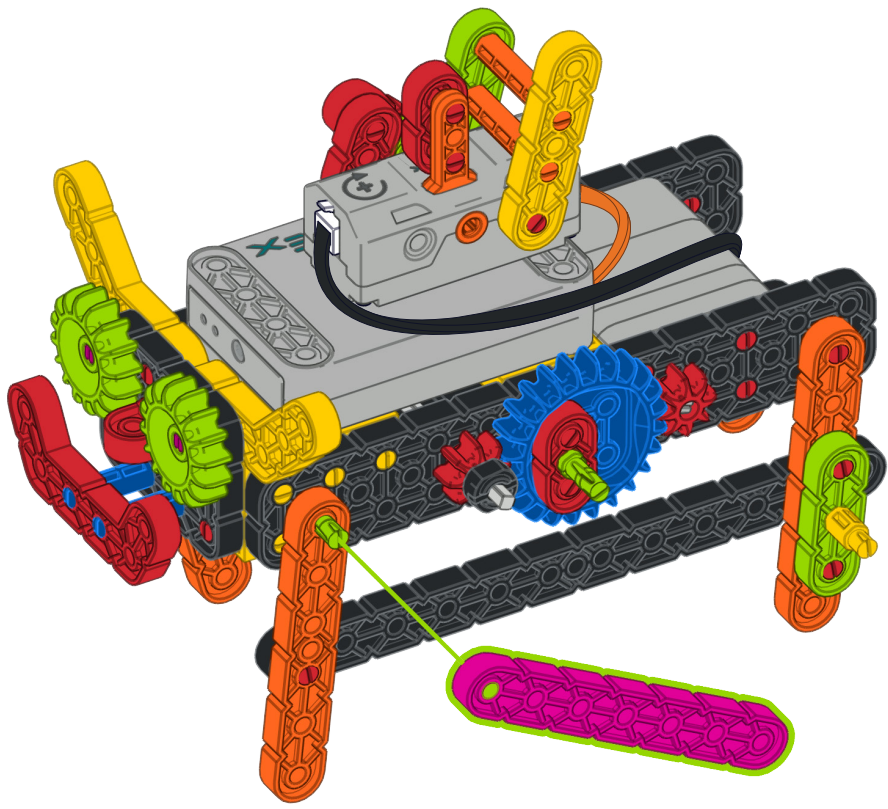

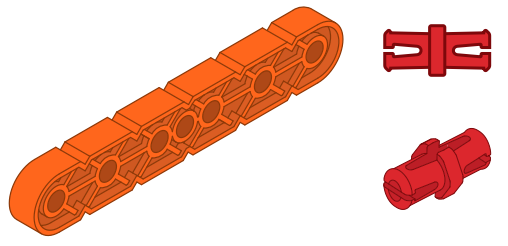
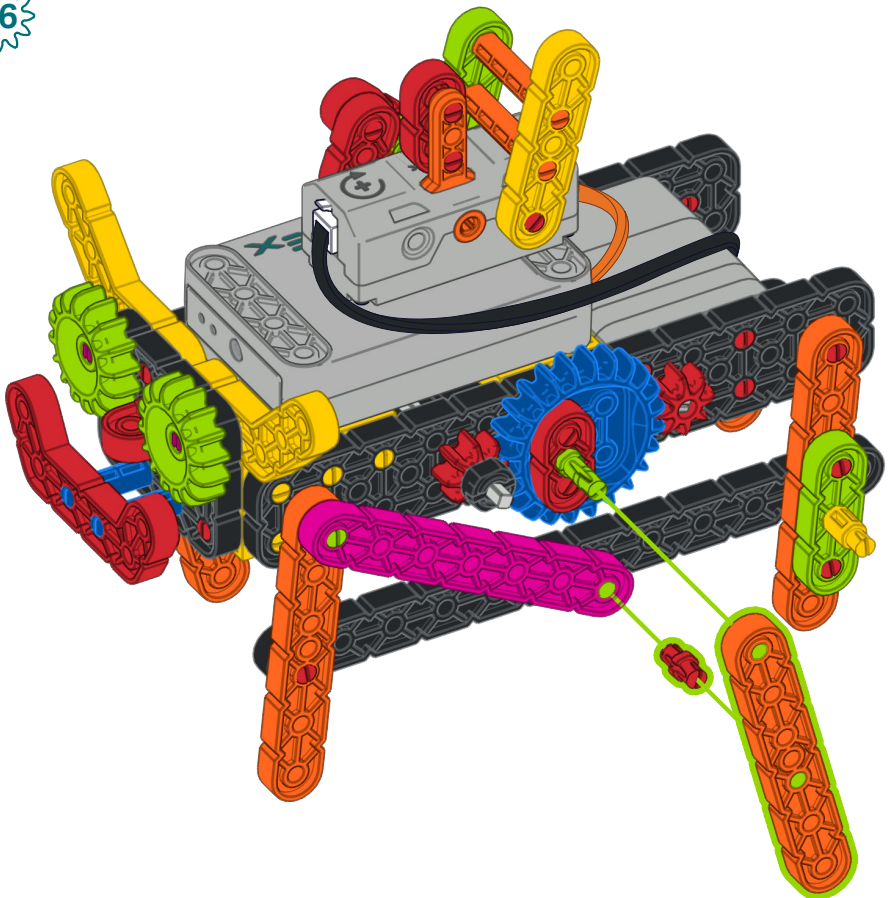

x1 Orange Beam

x1 Red Pin

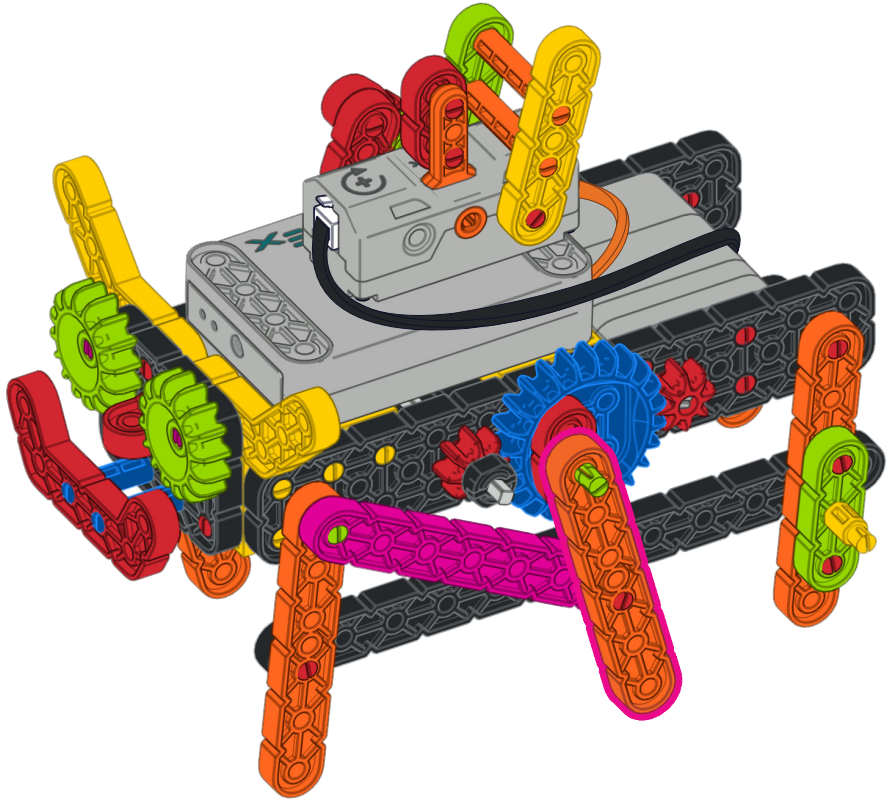

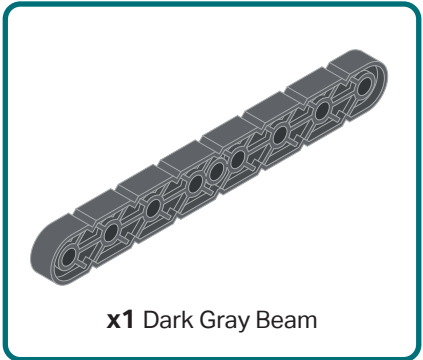
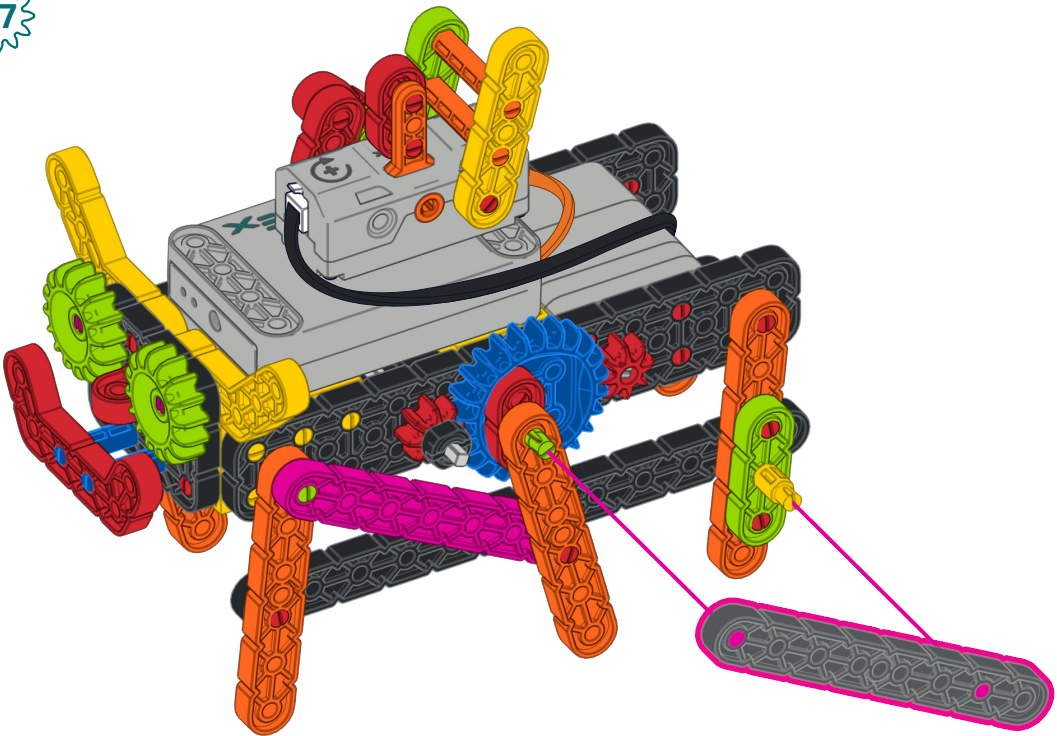

x1 Dark Gray Beam

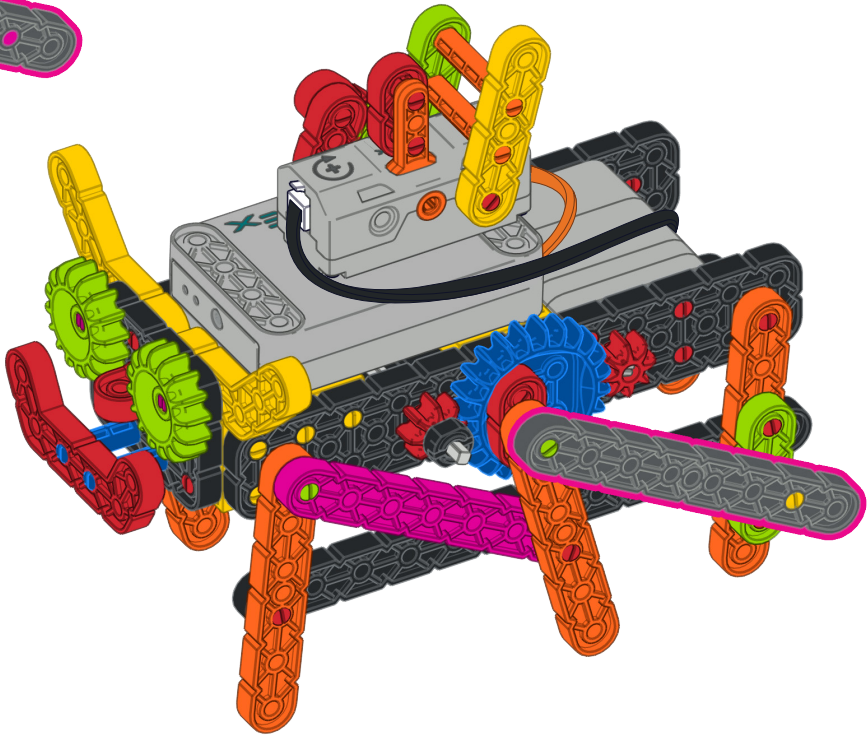

# Crawler Build Instructions

269-6912-180 Rev6



Custom manufactured in China for Innovation First Trading SARL. Distributed in the U.S.A, Mexico, Caribbean, Central & South America by VEX Robotics, Inc., 6725 W. FM 1570, Greenville, TX 75402, U.S.A. Distributed in China by Innovation First International (Shenzhen), Ltd., Suite 1906, Excellence Tower, 98 Fuhua Yi Road, Futian, Shenzhen, Guangdong, China 518048. Distributed in other regions by Innovation First Trading SARL, Innovation First Trading SARL, Parc Logistique Eurohub Sud, 3434 – Dudelange, Luxembourg +352 27 86 04 87. Distributed in Canada by / Distribué au Canada par / Innovation First Trading, LLC, 6725 W. FM 1570, Greenville, TX 75402, U.S.A.